



# Politecnico di Bari

Repository Istituzionale dei Prodotti della Ricerca del Politecnico di Bari

Advanced Computer Technologies for Integrated Agro-Hydrologic Systems Modeling: Coupled Crop and Hydrologic Models for Agricultural Intensification Impacts Assessment

This is a PhD Thesis

*Original Citation:*

Advanced Computer Technologies for Integrated Agro-Hydrologic Systems Modeling: Coupled Crop and Hydrologic Models for Agricultural Intensification Impacts Assessment / Siad, Si Mokrane. - ELETTRONICO. - (2018).  
[10.60576/poliba/iris/siad-si-mokrane\_phd2018]

*Availability:*

This version is available at <http://hdl.handle.net/11589/160122> since: 2019-01-18

*Published version*

DOI:10.60576/poliba/iris/siad-si-mokrane\_phd2018

Publisher: Politecnico di Bari

*Terms of use:*

(Article begins on next page)



Politecnico  
di Bari

Department of Civil, Environmental, Building Engineering and  
Chemistry

ENVIRONMENTAL AND BUILDING RISK AND  
DEVELOPMENT

SSD: ICAR/02–HYDRAULIC AND MARITIME  
CONSTRUCTION AND HYDROLOGY

**Final Dissertation**

---

Advanced Computer Technologies for  
Integrated Agro-Hydrologic Systems Modeling:  
Coupled Crop and Hydrologic Models for  
Agricultural Intensification Impacts Assessment

---

by

SIAD SI MOKRANE:

Supervisors:

Prof. Vito Iacobellis

DICATECh – Polytechnic University of Bari

Prof. Gerrit Hoogenboom

ABE – University of Florida

*Coordinator of Ph.D. Program:*

*Prof. Michele Mossa*

---

*Course n°31, 01/11/2015-31/10/2018*

- Department of Civil, Environmental, Building Engineering and Chemistry*
- Environmental and Building Risk and Development Ph.D. Program*
- SSD ICAR/02–Hydraulic and maritime construction and hydrology*



Politecnico  
di Bari

Department of Civil, Environmental, Building Engineering and  
Chemistry

ENVIRONMENTAL AND BUILDING RISK AND  
DEVELOPMENT

SSD: ICAR/02–HYDRAULIC AND MARITIME  
CONSTRUCTION AND HYDROLOGY

**Final Dissertation**

---

Advanced Computer Technologies for  
Integrated Agro-Hydrologic Systems Modeling:  
Coupled Crop and Hydrologic Models for  
Agricultural Intensification Impacts Assessment

---

by

SIAD SI MOKRANE:

Referees:

Prof. Francesco Gentile

Prof. Nicola Lamaddalena

Supervisors:

Prof. Vito Iacobellis

DICATECh – Polytechnic University of Bari

Prof. Gerrit Hoogenboom

ABE – University of Florida

*Coordinator of Ph.D. Program:*

*Prof. Michele Mossa*

---

Course n°31, 01/11/2015-31/10/2018

## *EXTENDED ABSTRACT (English)*

Coupling hydrologic and crop models is increasingly becoming an important task when addressing agro-hydrologic systems studies. Either for resources conservation or cropping systems improvement, the complex interactions between hydrologic regime and crop management components requires an integrative approach in order to be fully understood. Nevertheless, the literature offers limited resources on models' coupling that targets environmental scientists. Indeed, major of guides are are destined primarily for computer specialists and make them hard to encompass and apply. To address this gap, we present an extensive research to crop and hydrologic models coupling that targets earth agro-hydrologic modeling studies in its integrative complexity. The primary focus is to understand the relationship between agricultural intensification and its impacts on hydrologic balance. We provided documentations, classifications, applications and references of the available technologies and trends of development.

We applied the results of the investigation by coupling the DREAM hydrologic model with DSSAT crop model. Both models were upgraded either on their code source (DREAM) or operational base (DSSAT) for interoperability and parallelization. The resulting model operates at a grid base and daily step. The model is applied southern Italy to analyze the effect of fertilizer application on runoff generation between 2000 and 2013. The results of the study show a significant impacts of nitrogen application on water yield. Indeed, nearly 71.5 thousand cubic-meter of rain water for every kilogram of nitrogen and per hectare is lost as a reduction of runoff coefficient. Furthermore, a significant correlation between the nitrogen applications amount and runoff is found at a yearly basis with Pearson's coefficient of 0.93.

Key words: Models coupling, crop models, hydrologic model, DSSAT, DREAM, Runoff, Nitrogen

## *EXTENDED ABSTRACT (Italian)*

L'accoppiamento di modelli idrologici e di coltura sta diventando sempre più un compito importante quando si affrontano gli studi sui sistemi agro-idrologici. Sia per la conservazione delle risorse che per il miglioramento dei sistemi di coltivazione, le complesse interazioni tra regime idrologico e componenti di gestione delle colture richiedono un approccio integrativo per essere pienamente compresi. Tuttavia, la letteratura offre risorse limitate sull'accoppiamento di modelli che si rivolgono agli scienziati ambientali. In effetti, le guide principali sono destinate principalmente agli specialisti di computer e le rendono difficili da comprendere e da applicare. Per colmare questa lacuna, presentiamo un'estesa ricerca sui modelli di coltura e sui modelli idrologici che si rivolgono agli studi di modellizzazione agro-idrologica della terra nella sua complessità integrativa. L'obiettivo principale è capire la relazione tra l'intensificazione agricola e il suo impatto sull'equilibrio idrologico. Abbiamo fornito documentazione, classificazioni, applicazioni e riferimenti delle tecnologie disponibili e delle tendenze di sviluppo.

Abbiamo applicato i risultati dell'indagine accoppiando il modello idrologico DREAM con il modello di coltura DSSAT. Entrambi i modelli sono stati aggiornati sia sulla sorgente del codice (DREAM) che sulla base operativa (DSSAT) per l'interoperabilità e la parallelizzazione. Il modello risultante opera su una griglia e su un passo giornaliero. Il modello viene applicato nell'Italia meridionale per analizzare l'effetto dell'applicazione del fertilizzante sulla generazione di ruscellamento tra il 2000 e il 2013. I risultati dello studio mostrano un impatto significativo dell'applicazione dell'azoto sulla resa idrica. Infatti, quasi 71,5 mila metri cubi di acqua piovana per ogni chilogrammo di azoto e per ettaro vengono persi come riduzione del coefficiente di deflusso. Inoltre, una correlazione significativa tra la quantità di applicazioni di azoto e il deflusso si trova su base annuale con il coefficiente di Pearson di 0,93.

Parole chiave: Accoppiamenti di modelli, modelli culturali, Modelli idrologici, DSSAT, DREAM, Deflusso, Azoto

## *EXTENDED ABSTRACT (French)*

Le couplage des modèles hydrologiques et cultureux est une tâche importante lorsqu'on aborde les études de systèmes agro-hydrologiques. Que ce soit pour la conservation des ressources ou l'amélioration des systèmes de culture, les interactions complexes entre le régime hydrologique et les composantes de la gestion des cultures nécessitent une approche intégrative pour être pleinement comprises. Néanmoins, la littérature offre des ressources limitées sur le couplage de modèles qui cible les scientifiques. En effet, la plupart des guides sont principalement destinés aux informaticiens et sont difficiles à appliquer. Pour combler cette lacune, nous présentons une recherche approfondie sur le couplage des modèles de cultures et des modèles hydrologiques, qui cible les études de modélisation agro-hydrologique dans leur complexité intégrative. L'objectif principal est de comprendre la relation entre l'intensification agricole et ses impacts sur l'équilibre hydrologique. Nous avons fourni des documentations, des classifications, des applications et des références des technologies disponibles et des tendances de développement.

Nous avons appliqué les résultats de l'enquête en couplant le modèle hydrologique DREAM au modèle de culture DSSAT. Les deux modèles ont été mis à niveau soit sur leur code source (DREAM), soit sur leur base opérationnelle (DSSAT) pour assurer l'interopérabilité et la parallélisation. Le modèle résultant est appliqué dans le sud de l'Italie pour analyser l'effet de l'application d'engrais sur la production de ruissellement entre 2000 et 2013. Les résultats de l'étude montrent un impact significatif de l'application d'azote sur l'apport en eau. En effet, près de 71 500 mètres cubes d'eau de pluie par kilogramme d'azote et par hectare sont perdus sous la forme d'une réduction du coefficient de ruissellement. De plus, une corrélation significative entre la quantité d'application d'azote et le ruissellement est constatée chaque année avec un coefficient de Pearson de 0,93.

Mots clés: Couplage de modèles, modèles de culture, modèle hydrologique, DSSAT, DREAM, Ruissellement, Azote

## EXTENDED ABSTRACT (Arabic)

أصبحت نماذج الاقتران الهيدرولوجي والمحاصيل مهمة متزايدة الأهمية عند معالجة دراسات النظم الزراعية-الهيدرولوجية. سواء بالنسبة للحفاظ على الموارد أو تحسين نظم المحاصيل ، فإن التفاعلات المعقدة بين النظام الهيدرولوجي ومكونات إدارة المحاصيل تتطلب اتباع نهج تكاملي من أجل فهمها بشكل كامل. ومع ذلك ، توفر الأدبيات موارد محدودة حول اقتران النماذج التي تستهدف علماء البيئة. في الواقع ، يتم توجيه كبير من الأدلة في المقام الأول لمتخصصي الكمبيوتر وجعلها من الصعب أن تشمل وتطبق. ولمعالجة هذه الفجوة ، نقدم بحثاً موسعاً لاقتران النماذج المحصولية والهيدرولوجية التي تستهدف دراسات نمذجة الأرض الزراعية - الهيدرولوجية في تعقيدها التكاملي. ينعصب التركيز الأساسي على فهم العلاقة بين التكتيف الزراعي وتأثيره على التوازن الهيدرولوجي. قدمنا وثائق وتصنيفات وتطبيقات ومراجع للتكنولوجيات المتاحة واتجاهات التطوير.

قمنا بتطبيق نتائج التحقيق من خلال اقتران نموذج DREAM الهيدرولوجي مع نموذج المحاصيل DSSAT. تمت ترقية كلا الطرازين إما على مصدر الشفرة (DREAM) أو قاعدة التشغيل (DSSAT) للتشغيل البيئي والتوازي. يعمل النموذج الناتج على قاعدة شبكية وخطوة يومية. يتم تطبيق النموذج جنوب إيطاليا لتحليل تأثير تطبيق الأسمدة على توليد جريان المياه بين عامي 2000 و 2013. وتظهر نتائج الدراسة آثار كبيرة لتطبيق النيتروجين على إنتاجية المياه. في الواقع ، يتم فقدان ما يقرب من 71.5 ألف متر مكعب من مياه الأمطار لكل كيلوغرام من النيتروجين والهكتار الواحد كتخفيض في معامل الجريان السطحي. علاوة على ذلك ، يوجد ارتباط كبير بين كمية تطبيقات النيتروجين والجريان السطحي على أساس سنوي مع معامل بيرسون البالغ 0.93.

الكلمات المفتاحية: اقتران النماذج ، النماذج الزراعي ، النموذج الهيدرولوجي ، الجريان السطحي



## *INDEX/INDICE*

<i>EXTENDED ABSTRACT (ENGLISH)</i>	<i>1</i>
<i>EXTENDED ABSTRACT (ITALIAN)</i>	<i>2</i>
<i>EXTENDED ABSTRACT (FRENCH)</i>	<i>3</i>
<i>EXTENDED ABSTRACT (ARABIC)</i>	<i>4</i>
<i>EXTENDED ABSTRACT (AMAZIGH)</i>	<i>5</i>
<i>INDEX/INDICE</i>	<i>6</i>
<i>TABLES/TABELLE</i>	<i>9</i>
<i>FIGURES/FIGURE</i>	<i>10</i>
<i>ANNEXES/ALLEGATI</i>	<i>12</i>
<i>GENERAL INTRODUCTION</i>	<i>14</i>
<i>CHAPTER I: REVIEW OF COUPLING TECHNOLOGIES FOR AGRO-HYDROLOGIC SYSTEMS</i>	<i>20</i>
<i>1. INTRODUCTION</i>	<i>20</i>
<i>2. METHODS, FRAMEWORKS AND TOOLS FOR MODELS' COUPLING</i>	<i>21</i>
<i>2.1. METHODS</i>	<i>21</i>
<i>2.1.1. SEQUENTIAL COUPLING</i>	<i>21</i>
<i>2.1.2. LOOSE COUPLING</i>	<i>22</i>
<i>2.1.3. SHARED COUPLING</i>	<i>23</i>
<i>2.1.3.1. UNIFIED GRAPHICAL INTERFACE</i>	<i>23</i>
<i>2.1.3.2. SHARED DATA</i>	<i>24</i>
<i>2.1.4. EMBEDDED</i>	<i>25</i>
<i>2.1.5. INTEGRATED</i>	<i>25</i>
<i>2.1.6. THIRD-PART TOOL</i>	<i>26</i>
<i>2.2. REVIEW OF TOOLS AND FRAMEWORKS TECHNOLOGIES</i>	<i>27</i>
<i>2.3. INTEGRATED ENVIRONMENTAL MODELLING COMMUNITIES</i>	<i>42</i>
<i>3. DISCUSSION AND IMPLICATIONS</i>	<i>45</i>
<i>CHAPTER II: REVIEW OF COUPLED HYDROLOGIC AND CROP GROWTH MODELS</i>	<i>49</i>
<i>1. INTRODUCTION</i>	<i>49</i>
<i>2. CONCEPTS AND NOTIONS</i>	<i>50</i>
<i>2.1. CROP GROWTH MODELING</i>	<i>50</i>
<i>2.2. HYDROLOGIC MODELING</i>	<i>51</i>
<i>2.3. COMPLEMENTARILY OF SIMULATION PROCESSES</i>	<i>53</i>
<i>2.4. COUPLING MODELS</i>	<i>55</i>
<i>2.5. OPEN- AND CLOSED-SOURCE MODELS</i>	<i>56</i>
<i>3. REVIEW OF COUPLED HYDROLOGIC AND CROP GROWTH MODEL</i>	<i>57</i>
<i>4. DISCUSSION CONCLUSION</i>	<i>64</i>
<i>CHAPTER III: IMPLEMENTING PARALLEL</i>	

<i>PROCESSING FOR DSSAT MODEL</i>	<i>67</i>
<i>1. INTRODUCTION</i>	<i>68</i>
<i>2. SUMMARY OF DSSAT-CSM RUN STRUCTURE</i>	<i>69</i>
<i>3. METHOD DESCRIPTION AND TESTING</i>	<i>71</i>
<i>3.1. PARALLEL EXECUTION ROUTINE</i>	<i>72</i>
<i>3.2. BENCHMARK</i>	<i>76</i>
<i>4. DISCUSSION AND CONCLUSION</i>	<i>78</i>
<i>CHAPTER IV: VICA - GENETIC CALIBRATION TOOL FOR DSSAT MODEL</i>	<i>80</i>
<i>1. INTRODUCTION</i>	<i>81</i>
<i>2. VICA: VISUAL-BASED INSIGHTS CALIBRATION ANALOGUE</i>	<i>82</i>
<i>2.1. VICA USER INTERFACE</i>	<i>82</i>
<i>2.2. DIRECTORY STRUCTURE</i>	<i>86</i>
<i>2.3. EXECUTION STRUCTURE</i>	<i>87</i>
<i>3. THEORY AND CONCEPTS</i>	<i>88</i>
<i>3.1. BACKGROUND</i>	<i>88</i>
<i>3.2. CULTIVAR COEFFICIENTS SOLVER</i>	<i>89</i>
<i>4. DISCUSSION AND CONCLUSION</i>	<i>92</i>
<i>CHAPTER V: DETERMINATION OF PLANTING DATE USING MODIS LEAF AREA INDEX</i>	<i>94</i>
<i>1. INTRODUCTION</i>	<i>94</i>
<i>2. MATERIAL AND METHODS</i>	<i>94</i>
<i>2.1. BASE PRINCIPLE</i>	<i>96</i>
<i>2.2. ILLUSTRATION SETS</i>	<i>96</i>
<i>2.3. DESCRIPTION</i>	<i>96</i>
<i>3. CONCLUSION AND RECOMMENDATIONS</i>	<i>101</i>
<i>CHAPTER VI: DREAM-DSSAT COUPLED HYDRO-CROP MODEL FOR INTEGRATED AGRO-HYDROLOGIC SYSTEM STUDY</i>	<i>103</i>
<i>1. INTRODUCTION</i>	<i>103</i>
<i>2. MATERIAL AND METHOD</i>	<i>104</i>
<i>2.1. STUDY BACKGROUND</i>	<i>105</i>
<i>2.2. STUDY CASE</i>	<i>105</i>
<i>2.3. DATA</i>	<i>107</i>
<i>2.4. MODELING FRAMEWORK</i>	<i>108</i>
<i>2.4.1. MODEL PRESENTATION</i>	<i>111</i>
<i>2.4.1.1. THE DREAM MODEL</i>	<i>111</i>
<i>2.4.1.2. THE DSSAT MODEL</i>	<i>111</i>
<i>2.4.2. PROCEDURE</i>	<i>111</i>
<i>2.4.3. MODELS' SETUP</i>	<i>113</i>
<i>2.4.3.1. DSSAT</i>	<i>113</i>
<i>2.4.3.2. DREAM AND COUPLER</i>	<i>115</i>
<i>3. RESULTS</i>	<i>115</i>
<i>3.1. SIMULATIONS</i>	<i>115</i>

<i>3.1.1. DREAM MODEL</i>	<i>115</i>
<i>3.1.2. DSSAT MODEL</i>	<i>117</i>
<i>3.1.3. DREAM-DSSAT COUPLED MODEL</i>	<i>120</i>
<i>3.1.4. REVERSED DREAM-DSSAT COUPLED MODEL</i>	<i>122</i>
<i>3.2. ANALYSIS</i>	<i>124</i>
<i>4. DISCUSSION AND CONCLUSION</i>	<i>127</i>
<i>GENERAL CONCLUSION</i>	<i>130</i>
<i>RECOMMENDATIONS AND FURTHER WORKS</i>	<i>132</i>
<i>ACKNOWLEDGEMENTS</i>	<i>134</i>
<i>ANNEXES</i>	<i>136</i>
<i>REFERENCES</i>	<i>147</i>

## **TABLES/TABELLE**

<i>Tab. 1- Couplers' implementation</i>	27
<i>Tab. 2- Coupling tools/frameworks</i>	29
<i>Tab. 3-Tools /frameworks references</i>	39
<i>Tab. 4- Coupling frameworks/tools-based communities</i>	43
<i>Tab. 5- Models/software packages communities: Crop</i>	44
<i>Tab. 6- Models/software packages communities: Hydrology</i>	44
<i>Tab. 7- Models/software packages communities: Other</i>	45
<i>Tab. 9- List of coupled hydrologic and crop models' studies</i>	59
<i>Tab. 10- Table of requirements</i>	72
<i>Tab. 11- Description of the BAT Parallelizer code</i>	72
<i>Tab. 12- Time benchmark assessment for different sets of runs</i>	76
<i>Tab. 13- VICA GUI sections description</i>	85
<i>Tab. 14- VICA routines description and organization</i>	87
<i>Tab. 15- Variables and classes matrix</i>	91
<i>Tab. 16- Study materials and methods summary</i>	104
<i>Tab. 17- Hydro-meteorological data</i>	107
<i>Tab. 18- Initial soil conditions</i>	114
<i>Tab. 19- Simeto cultivar coefficients</i>	114

## FIGURES/FIGURE

<i>Fig. 1- Sequential coupling</i>	22
<i>Fig. 2- Loose coupling</i>	23
<i>Fig. 3- Unified graphical interface coupling</i>	24
<i>Fig. 4- Shared data coupling</i>	24
<i>Fig. 5- Embanded coupling</i>	25
<i>Fig. 6- Integrated coupling</i>	26
<i>Fig. 7- Schema of typical integrative coupler framework</i>	26
<i>Fig. 9- Example of catchment with water distribution (ESA/AOES-Medialab, 2004b)</i>	52
<i>Fig. 10- Soil water balance interaction with vegetation (ESA/AOES-Medialab, 2004a)</i>	54
<i>Fig. 11- Compromise between methods and integration</i>	57
<i>Fig. 12- Up/down simulation scaling</i>	64
<i>Fig. 13- Example of up/downscaling of rainfall data</i>	65
<i>Fig. 14- Example of up/downscaling of wind data</i>	65
<i>Fig. 15- Summary of DSSAT-CSM execution structure</i>	70
<i>Fig. 16- Example of DSSAT's batch file</i>	71
<i>Fig. 17- DSSAT-CSM parallel execution structure</i>	72
<i>Fig. 18- Time benchmark of setoff runs with different core-count configuration</i>	77
<i>Fig. 19- Difference increase of time and core-count</i>	78
<i>Fig. 20- VICA GUI</i>	83
<i>Fig. 21- VICA directories structure</i>	86
<i>Fig. 22- VICA execution structure</i>	87
<i>Fig. 23- Example of error records <math>e</math> in function of cultivar coefficient <math>x_i</math>.</i>	88
<i>Fig. 24- Example of error records <math>e</math> in function of two cultivar coefficients <math>x_i</math>.</i>	90
<i>Fig. 25- MODIS' LAI data fitting using some of parabolic functions</i>	97
<i>Fig. 26- MODIS' LAI data series deviation according to local minimums and maximums</i>	97
<i>Fig. 27- Example of flat zones locations</i>	98
<i>Fig. 28- Planting date interval</i>	99
<i>Fig. 29- Last minimum in the planting date interval: Application to the DSSAT-Ceres model</i>	100
<i>Fig. 30- DSSAT-Ceres LAI at emergence</i>	100
<i>Fig. 31- The Celone at. San Vincenzo watershed.</i>	107
<i>Fig. 32- DREAM-DSSAT coupling framework</i>	109
<i>Fig. 33- Layers structure and data coupling</i>	110
<i>Fig. 34- DREAM-DSSAT modeling framework</i>	110
<i>Fig. 35- Celone's division For DSSAT spatialization</i>	112
<i>Fig. 36- soil and weather station distributions</i>	112
<i>Fig. 37- DREAM's raster's inputs based on soil-weather homogeneity</i>	113
<i>Fig. 38- Simulated vs. recorded discharges for the Celone watershed (2000-2013)</i>	116
<i>Fig. 39- Average yearly runoff of the Celone watershed</i>	117
<i>Fig. 40- MODIS vs. DSSAT's LAI for different scenarios</i>	118
<i>Fig. 41- LAI relation to N application for the different scenarios</i>	118
<i>Fig. 42- N productivity for LAI</i>	119
<i>Fig. 43- Yield relation to N application for the different scenarios</i>	119
<i>Fig. 44- N productivity for yield</i>	120

<i>Fig. 45- Simulated vs. recorded discharges for the Celone watershed (2000-2013)</i>	<i>122</i>
<i>Fig. 46- N application candidates for the period 2000-2013</i>	<i>122</i>
<i>Fig. 47- LAI spatial mean 2000-2013</i>	<i>123</i>
<i>Fig. 48- N vs. LAI</i>	<i>123</i>
<i>Fig. 49- Total discharge volume 2000-2013 for the all scenarios</i>	<i>124</i>
<i>Fig. 50- Discharge volume gain/loss vs. increment in N application</i>	<i>125</i>
<i>Fig. 51- Ratio runoff/N for the period 2000-2013</i>	<i>125</i>
<i>Fig. 52- Runoff vs. N</i>	<i>126</i>
<i>Fig. 53- Finite difference of N application and runoff production</i>	<i>127</i>

## Equations/Equazioni

Eq. 1: $\forall n \in \mathbb{N}^*$ , $e = F(x_1, x_2, x_3, \dots, x_n)$	88
Eq. 2: $\forall i \in \mathbb{N}^*$ , $e = f(x_i) = a \cdot x_i^2 + b \cdot x_i + c$	88
Eq. 3: $\forall i \in \mathbb{N}^*$ , $\forall (X, x_i) \in I_i$ , $f(X) \leq f(x_i)$	89
Eq. 4: $\Rightarrow f'(x_i) = 0$	89
Eq. 5: $\forall n \in \mathbb{N}^*$ , $\forall \{(X_1, x_1), \dots, (X_n, x_n)\} \in \{I_1^2, \dots, I_n^2\}$ , $F(X_1, \dots, X_n) \leq F(x_1, \dots, x_n)$	89
Eq. 6: $\Rightarrow F'(x_1, \dots, x_n) = 0$	89
Eq. 7: $\forall i, m \in \mathbb{N}^*$ , $I_i = C_k^i 1 \cup C_k^i 2 \cup C_k^i 3 \cup \dots \cup C_k^i m$	90
Eq. 8: $KGE = 1 - \sqrt{((r-1)^2 + (\alpha-1)^2 + (\beta-1)^2)}$	91
Eq. 9: $r = \frac{\text{cov}(\text{sim}, \text{obs})}{\sigma_{\text{sim}} \cdot \sigma_{\text{obs}}}$	91
Eq. 10: $\beta = \mu \left( \frac{\text{sim}}{\text{obs}} \right)$	91
Eq. 11: $\alpha = \frac{\sigma_{\text{sim}}}{\sigma_{\text{obs}}}$	91
Eq. 12: $Q = m^n$	91
Eq. 13: $\forall i, j, k, m \in \mathbb{N}^*$ , $C_k^i j = c_k^i 1 \cup \dots \cup c_k^i m$	91
Eq. 14: Condition: $c_k^i j \leq PL \cdot I_i$	91
Eq. 15: $\forall i, j, k \in \mathbb{N}^*$ , $\exists c_k^i j \in I_i$ , $f(c_{k+1}^i j) \geq f(c_k^i j)$	92
Eq. 16: $w_{sc} = 0.2 \cdot LAI$ (mm)	120
Eq. 17: $\frac{\Delta w_c}{\Delta t} = p_v - e_{wc}$	121
Eq. 18: $e_{wc} = (w_c / w_{sc})^{2/3} \cdot e_{wct}$ if $w_c > 0$	121

## **ANNEXES/ALLEGATI**

<i>Ane. 1- Biccari: 2007-2008 Tops weight</i>	138
<i>Ane. 2- Biccari: 2007-2008 LAI</i>	139
<i>Ane. 3- Orsara di Puglia: 2007-2008 Tops weight</i>	139
<i>Ane. 4- Orsara di Puglia: 2007-2008 LAI</i>	140
<i>Ane. 5- Faeto: 2007-2008 Tops weight</i>	141
<i>Ane. 6- Faeto: 2007-2008 LAI</i>	142
<i>Ane. 7- Orto di Zolfo: 2007-2008 Tops weight</i>	143
<i>Ane. 8- Orto di Zolfo: 2007-2008 LAI</i>	144
<i>Ane. 9- Troia: 2007-2008 Tops weight</i>	145
<i>Ane. 10- Troia: 2007-2008 LAI</i>	146

---

## *General introduction*

---

## General introduction

### General introduction

Food security, as defined by the United Nations' Committee on World Food Security, is the condition in which all people, at all times, have physical, social and economic access to sufficient safe and nutritious food that meets their dietary needs and food preferences for an active and healthy life. Nevertheless, globalization, rise of living standard, increase of life expectancy and economic competition are some of the leading factors that accelerate human pressure on the environment in order to feed a continuously growing population (Shirokanov, 2014). Over the coming decades, a changing climate and market price instability will have significant yet highly uncertain impacts on food security.

Scientists participate, to address food security and related environmental issues, by developing models with which they can experiment and search for potential solutions and enhance our understanding (Brandmeyer and Karimi, 2000). The role of simulation models has increased significantly in understanding the processes in the soil-plant-atmosphere system in recent years (Jones et al., 2003). Mathematical models physically or empirically based, have the promising potential to explore solutions to water sustainability and food security problems. Evaluation of water management scenarios helps to provide better recommendations to enhance productivity and water economy (Pauwels et al., 2007b).

Many complex processes occur within and between environmental media (e.g., air, surface, groundwater, soil, and crop) (Lambin et al., 2000). Specialized simulation models are strong in this regard; they can simulate the processes and predict the variables' state at every stage of the simulation (Ines et al., 2001). Models validation with field observations, or intercomparing models, provides information on the models'

## General introduction

performance and will reveal their strong and weak points (Biondi et al., 2012). This is a crucial step in selecting adequate models for practical applications. Model comparison will give information on how a model fares in its performance respectively to the other (Thornton and Hoogenboom, 1994). If the simpler model can adequately simulate the processes, then this could be an alternative to the complex and data intensive one. This does make sense economically speaking because this will minimize the need for data in the simulation. However, this should not be the only criterion because a model has to be robust enough in most of the conditions prevailing in the system if its relative capability has to be considered (Pereira et al., 2015).

Hydrological practice has been developed to its greatest degree to the study of water resources from large catchments, usually for industrial and domestic consumption (Jia et al., 2011). Historically, hydrological practice has had a limited role in agriculture. Even where large-scale irrigation schemes have been undertaken (Betts, 2005), civil or agricultural engineering expertise has usually taken a dominant place. But with a continuous interest in improving poor and marginal regions of agricultural activity, where capital investment is uneconomic, in-depth understanding of the hydrological conditions that prevail is essential (Bormann et al., 2007, Bormann et al., 2009, Breuer et al., 2009, Huisman et al., 2009, Viney et al., 2009, Antonelli et al., 2015).

Particularly where agriculture is a subsistence activity, or where water harvesting is the determinant of agricultural production, knowledge of the hydrological environment is crucial to determine the existence of optimal soil moisture conditions, and how to exploit them (Webb et al., 2011, Boegh et al., 2004b). The impacts of hydrological conditions on farming practice and farming systems are substantial, and

## General introduction

in the case of rainfed crops, the availability, timing and volume of surface runoff is critical to success or failure of the season's yield (Soler et al., 2007a).

Anticipation of watershed's river fluxes, within a changing environment and under changing boundary conditions, is an important, but yet not easy task, requires integrative models with strong parameterization in order to be realistically evaluated. Furthermore, such models have to be evaluated for several environmental conditions (ex: soils and vegetation cover, climatic conditions, topography) to be able to assess and quantify human induced impacts. Nonetheless, investigating a multidimensional and heterogeneous problems requires models that are generally expensive to develop and difficult to maintain (Boegh et al., 2004b). As scientific understanding advances, new models are developed and existing ones are enhanced leading to a large body of codes (Ritchie et al., 2009). In addition to the costs normally associated with design and development (Gross et al., 2016), models' results must be compared to field observations and may be challenged by data scarcity (Webber et al., 2010).

Due to time and money concerns, a current approach in model development is to couple legacy models (Argent, 2004), and replacement only when necessary. The challenges addressed by such approach is the numerous existing methodologies (Salas et al., 2012). Indeed, when coupling existing models, identifying the components required to link them is central to the coupling design (Kakpakov and Polukarova, 1975). Coupling provides a practical approach to thinking about 'modeling in the large' which forces attention beyond the scope of definition to include operations upon models as well. Model is not a formal notion but rather a useful concept, which may be considered as another analogy of data management and exchange between models.

## General introduction

The present thesis aims to provide an initiation to model coupling practices applied to agro-hydrologic systems. In addition to reviews of existing methodologies and their applications alongside with their applied studies, we provided a detailed example of work by coupling the Decision Support System for Agrotechnology Transfer (DSSAT) model (Jones et al., 2003) with the Distributed Runoff, Evaporation and Antecedent soil Moisture model (DREAM)(Manfreda et al., 2005). The work encompasses major steps involved in coupling which are model interoperability, integrability, data cohesion and homogenization, and models' upgrade. Most importantly, as Manfred Eigen quoted "*A theory has only the alternative of being right or wrong. A model has a third possibility: it may be right, but irrelevant.*", the resulting coupled model is applied southern Italy for integrated study of the impacts of fertilizer application of runoff yield

---

*CHAPTER I:*

*REVIEW OF COUPLING  
TECHNOLOGIES FOR AGRO-  
HYDROLOGIC SYSTEMS*

---

# CHAPTER I: REVIEW OF COUPLING TECHNOLOGIES FOR AGRO-HYDROLOGIC SYSTEMS

## 1. Introduction

Numerical models took place as tools for supporting and enhance understanding of the processes involved in the agro-hydrological systems (Brandmeyer and Karimi, 2000). Indeed, the use of simulation models in soil-plant-atmosphere interactions studies is continuously increasing (Jones et al., 2003). Physically or empirically mathematical models have a promising potential for exploring solutions related to water conservation and sustainable management. Thus, they are robust decision-making tools at the farm and catchment level, for supporting the handling of croplands under marginal climatic and pedogenic conditions. Furthermore, they are also used to assist in selecting the most suitable practices and best cultivars for a given climatic region, as well as for a given risk imposed by pests and diseases. Additionally, they also help in deciding on opportunities and economic investments. Especially, where agricultural pricing and policies have a high impacts on farmers' incentives to have a high control of their cropping systems (Siad et al., 2017).

Yet, current hydrologic and crop models cannot handle alone all the biophysical processes occurring in the agro-hydrological system level. For example, field modeling studies confirmed that interactions within crop-hydrologic systems are central in short- and long-term simulations. Due to time and budget constraints, the current approach adopted in model development is the coupling of hydrologic and crop legacy models (Argent, 2004). The challenges addressed by such an approach are the large body of simulation codes and the numerous existing technics (Salas et al., 2012). Indeed, when coupling existing models, identifying the components required to link them is central for the coupling design, resulting in system integration problems (Kakpakov and Polukarova, 1975).

This chapter presents an extensive synthesis of technologies, methodologies and tools available for coupling models related to study agro-hydrologic systems and

their interactions. In addition, we provided decision support recommendations for models coupling.

## 2.Methods, frameworks and tools for models' coupling

An exhaustive and universal method for coupling hydrologic with crop growth models has not been yet developed. Also, all the existing methods and frameworks are purely software-based approach. The following review summarizes the common techniques used. Depending on requirements of the specific analysis, they range between a simple hand-made data exchange (inputs/outputs) between the models to be coupled, to a full source cods' integration.

### 2.1.Methods

#### 2.1.1.Sequential coupling

This is the simplest coupling hierarchy form (Fig. 1). Data have to be transferred from Model A to Model B (or from Model B to Model A). The models can be operated on binary data stored in different formats or languages and executed under different operating systems. In all cases, the data transfer is done through a series of manual extraction, transfer, and conversion processes. In some cases, a manual-edited data file may be also required.

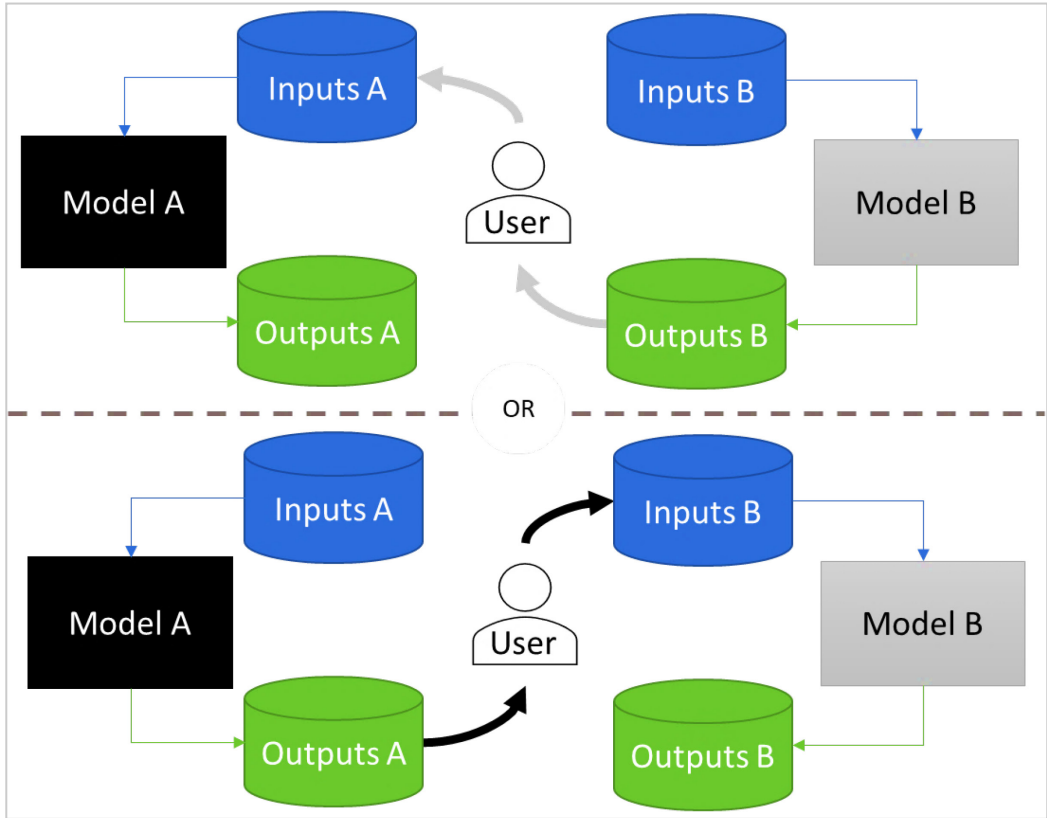

Fig. 1- Sequential coupling

The models are separated and coupled only in the sense that the output produced by one model becomes an input to another. The minimal design, development, and testing requirements of this coupling method reduce its initial cost. The cost advantage of not developing an automated transfer method is lost if data must be manually and frequently transferred between the two models.

### 2.1.2. Loose coupling

Unlike the sequential coupling method, data transfer in loose coupling is automated between Models A and B. In addition, data may be interchanged in a dynamic feedback during the simulation (Fig. 2). Often, a series of steps, involving

extraction of data of a certain structure in Model A, and its conversion to data of another structure in Model B is required.

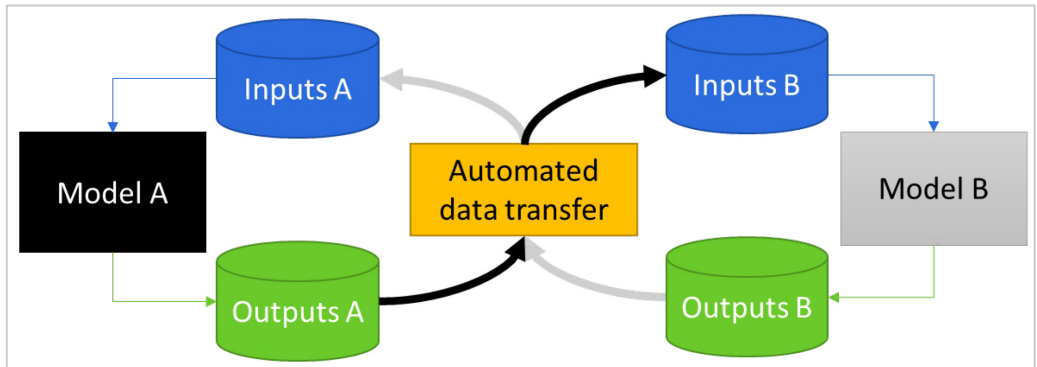

Fig. 2- Loose coupling

The automatic data transfer is done by using a third-part software, for example GIS, employed as a pre-processor or postprocessor for transfer, reducing time on data collection and manipulation by several folds. Consequently, the user could more easily modify and analyze alternatives.

### 2.1.3.Shared coupling

In shared coupling, the models share external components, either through the Graphical User Interface (GUI) or data storage. A single graphical interface links the models in GUI coupling, but data are separately stored for each of the models A and B. In contrast, in data coupling, the models share data storage but not the user interfaces, thereby, the user is required to interact with each model.

#### 2.1.3.1.Unified Graphical Interface

The GUI provides the modeler with access to a virtual environment (Fig. 3). The single GUI provides a user-friendly method of coupling the models while hiding the internal coupling method, therefore, the models are less confusing. The user is no longer aware of the locations or configurations of computer systems being accessed.

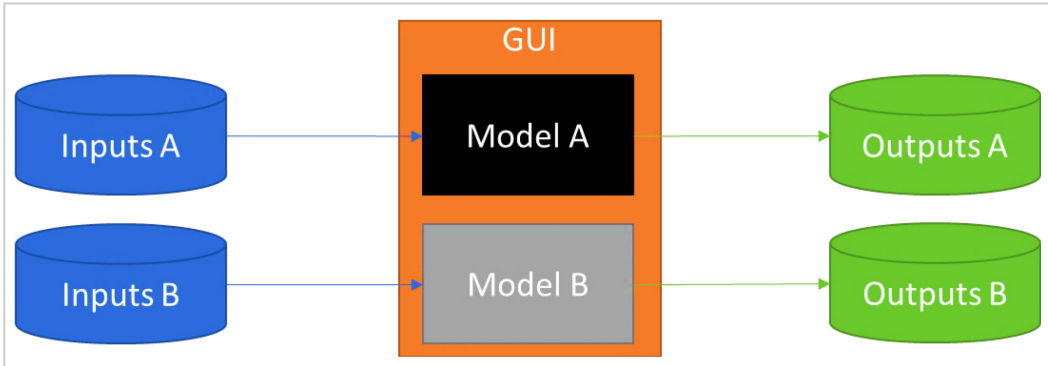

Fig. 3- Unified graphical interface coupling

### 2.1.3.2.Shared data

In the shared data method (Fig. 4)the user has simultaneous, direct and separate interactions, with each model. The models may share data files when needed. This technique is less frequently used. Also, models are generally independently developed and not as a part of a modeling system. Therefore, the data structure is optimized for each modeling or computer architecture. In addition, limitations due to proprietary rights for some models restrict the ability to share data files.

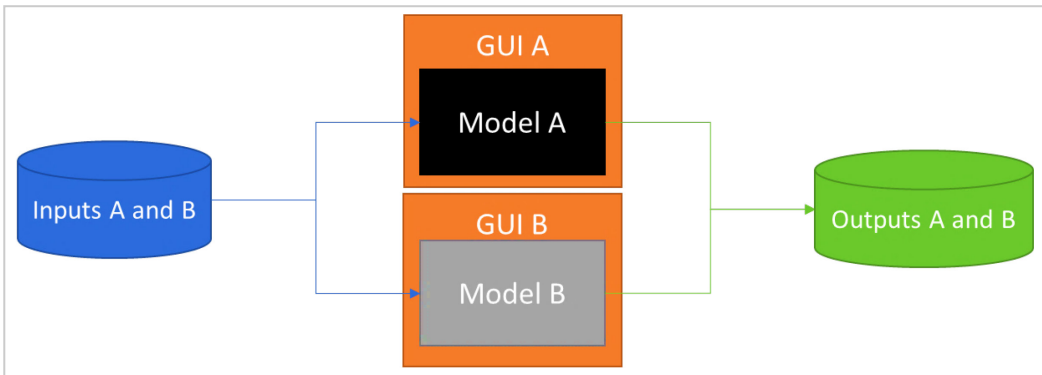

Fig. 4- Shared data coupling

The computer industry provides several methods for sharing data, such as: Open Database Connectivity (ODBC), Object Linking and Embedding (OLE) and Dynamic Data Exchange (DDE). However, none of these data sharing methods

supports all: (i) the data types (e.g., integer, float, double, text, logical, date, time, multidimensional array, sparse array), geospatial data (e.g., point, vector, arc, polyline, polygon, volume, raster), and multimedia data (e.g., images) in environmental modeling; and (ii) four dimensions (i.e., x, y, z, and time), including heights both above and below a specified sea level datum, terrain- following heights, and pressure-defined heights.

#### 2.1.4. Embedded

In this methodology, Model A contains Models B in a subroutine relationship (Fig. 5). The user interacts only with the host model through its GUI (Model A).

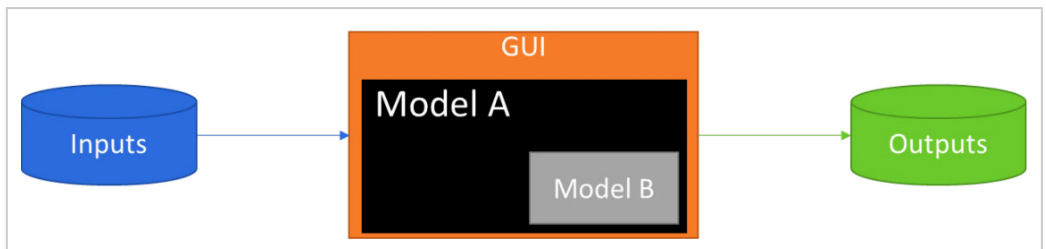

Fig. 5- Embanded coupling

When an adequate programming language is used, simple mathematical models may be easily embedded. The GUI enables the user to display, interact, calculate, and modify model's parameters for various simulations.

#### 2.1.5. Integrated

In this method, each model is peered to the other model (Fig. 6). The common GUI allows the user to interact independently with any model. The functions and subroutines are integrated through shared libraries. Nevertheless, if the computing environment is heterogeneous, these libraries must be duplicated for each type of computer/operating system.

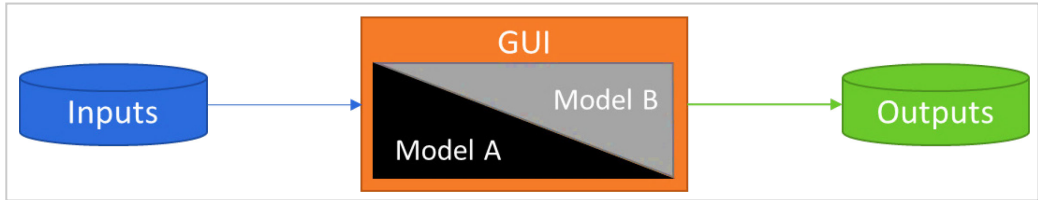

Fig. 6- Integrated coupling

### 2.1.6.Third-part tool

Using an overall modeling framework, the models are coupled by using a third-part tool commonly called “Coupler” (Fig. 7). The framework itself comprises both joined and shared coupling, and presented as a single GUI to the modeler, with a shared data storage.

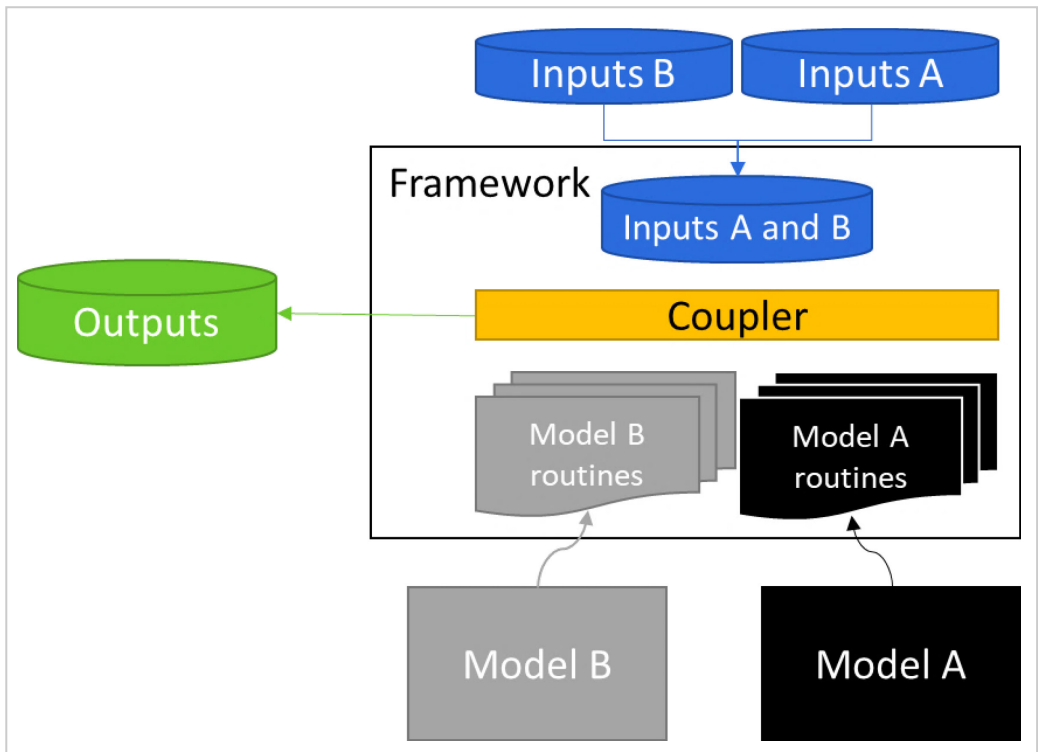

Fig. 7- Schema of typical integrative coupler framework

## 2.2.Review of tools and frameworks technologies

The framework may be implemented with server technology on the networked computers within heterogeneous computing environments. Tab. 1 summarizes the advantages and disadvantages of such integration with web services. In addition, while managing data and computing resources, this framework also provides tools and functions common to multiple models. Studies involving complex interactions between models and data facilitate the process of coupling thanks to the cohesive modeling framework.

Tab. 1- Couplers' implementation

Base approach	Characteristics	Advantage	Disadvantages
Component based	Models are presented as modules/ components that can be replaced, upgraded and reused.	Plug & play; separation of concern; minimizes context switching time of components; system level functionalities.	Challenging development of interoperable modules.
Web service based	Models are presented as web services; loosely coupled systems; distributed services.	Plug & play; location independence; platform independence; scalable.	May require heavy data exchange, and high availability.
Hybrid	A mix of components and web services of models 'presentation.	Enables linkage to different frameworks; manage heterogeneity; reuse existing frameworks.	Requires parsing data between components and services.
Custom-made	Tailor-made techniques with ad-hoc collection of methods/techniques	Use of ad-hoc techniques for coordination.	May not support models' updates; rigid structure.

According to Dunlop et al., the framework coupling technologies can be formally divided into coupling libraries, frameworks, and workflows (Dunlap et al., 2013). Nevertheless, there are significant overlaps between the technologies. While all couplers have the same basic functions, they do differ in the level of components standardization, data exchange, and degree of integration. Furthermore, the existing

methods of coupling are perceived as either data, models, or information-centric. Thus, there is a growing need of methods that facilitate generic coupling of both data and models.

Tab. 2, along with the Tab. 3, indicate that there are numerous available solutions of frameworks and tools. Even addressing multiparadigm systems, all have restrictions on their use and are tailored to the issues facing their users/communities.

Tab. 2- Coupling tools/frameworks

**CF** : Coupling Framework; **F** : Framework; **GC** : Generic Components; **W/O** : Workflow/Orchestration; **L/I** : Language/Interface.

Tool/framework	Type	Description	References
AGROBASE Generation II	F	A Windows-based software licensed as a CORE System, with additional modules licensed separately. The CORE System and modules are being enhanced annually.	(Wallach and Rellier, 1987, Mulitze, 1990)
APSIM framework	F	Composed of a suite of modules which enables the simulation of systems that cover a range of plant, animal, soil, climate and management interactions.	(Keating et al., 2003a)
ARAMS	F	Information delivery, dynamic modeling and analysis system that integrates multimedia fate/transport, intake/uptake and effects of contaminants and military-relevant components.	(USACE, 2017)
ARIES	W/O	A tool for assessing and validating ecosystem services in decision making.	(Bagstad et al., 2011)
BASINS	F	GIS based integrated modeling and assessment tools with watershed data.	(Lahlou et al., 1998)
BFG	F	A system for writing customized wrapper code for linking Fortran models. it uses XML to capture metadata describing models, how they exchange, and how they can be run.	(Armstrong et al., 2009)
BPEL	L/I	An OASIS standard executable language for specifying actions within business processes with web services.	(Arkin et al., 2005)

Coupling tools/frameworks (continue)

CCA	L/I	A standard for Component-based software engineering. The CCA model components provide functionalities through export interfaces.	(Armstrong et al., 2006)
CCMP	GC	A set of interchangeable individual modules covering all aspects of hydrodynamics, ecosystem dynamics and watershed interactions towards a future linked watershed-estuary model.	(CCMP, 2017)
C-Coupler (C-Coupler1)	CF	A parallel 3-D coupler that achieves a higher-level sharing, where the component models and the coupler can keep the same code version.	(Liu et al., 2014)
CESM (EX. CCSM)	F	A centralized coupler component with integration of MCT and flux computation.	(Kay et al., 2015)
CHPS	GC	A US National Weather Service (NWS) initiative that uses Delft-FEWS for a nationwide early warning system.	(Roe et al., 2010)
CHyMP	CF	A CUAHSI initiative to develop, provide and support advanced simulation models for the academic community within a community-based 'development-user-feedback' framework.	(Famiglietti et al., 2008)
CMP	F	A set of rules for building simulation software in a modular set.	(Moore et al., 2007)
CSDMS	GC	A framework software that provides models for simulation of earth surface processes such as sediment dynamics and hydrology on High-Performance Computing platform.	(Peckham, 2008)

Coupling tools/frameworks (continue)

DDB	CF	A tool for coupled systems that deal with large volumes of data exchanges and/or are computational expensive.	(Drummond et al., 2001)
elft-FEWS	GC	Whether on a server or stand-alone model, it can operate around data and model as workflow or run in centralized database.	(Werner et al., 2013)
Delta Shell	F	An integrated modeling environment with a focus to setup, configuration, run and analyze results of the integrated environmental models.	(Donchyts and Jagers, 2010)
DIAS	CF	An object-oriented simulation system providing an integrating framework in which new or legacy software applications can operate in a context-driven frame of reference.	(Sydelko et al., 1999)
DSSAT	F	A set of computer programs for simulating agricultural crop growth. Built with a modular approach with extended interfaces such as GIS.	(Jones et al., 2003)
EnSym	F	A computer program designed to model the impacts of landscape modeling on the environment using spatial information.	(Ha et al., 2010)
ESMF	F	A high-performance, flexible software infrastructure for climate, numerical weather prediction, data assimilation, and other earth science applications.	(Hill et al., 2004)
EvoLand/ ENVISION	F	Spatially explicit environmental assessment tool and multi-agent based regional planning.	(Bolte et al., 2007)

Coupling tools/frameworks (continue)

FluidEarth	F	OpenMI-wrapped based model.	(Harpham et al., 2014)
FMS	F	A software framework for efficient development, construction, execution, and scientific interpretation of atmospheric, oceanic, and climate system models.	(Balaji, 2012)
FrAMES	F	Allows coupling of gridded terrestrial model outputs with an aquatic modeling component to explore nitrogen and water kinetics.	(Wollheim et al., 2008)
FRAMES	F	A statistically based risk assessment framework.	(Babendreier and Castleton, 2005)
FSE	L/I	FORTRAN 77 programming environment for continuous simulation of agro-ecological processes, such as crop growth and water balances.	(Kraalingen, 1995)
GCF	CF	Using lightweight development rules for single models, coupling is achieved on information, composition and deployment onto computational resources as machine-readable metadata.	(Ford et al., 2006)
GME (1)	CF	Designed for spatial analysis and modeling. The framework provides a suite of analysis and modeling tools for sophisticated workflow and self-contained analysis programs.	(Beyer, 2017)
GME (2)	CF	A configurable toolkit for creating domain-specific modeling and program synthesis environments.	(Molnár et al.)
GMS/WMS/SMS	GC	Groundwater, watershed, and surface water modeling systems framework.	(Aquaveo, 2017)

Coupling tools/frameworks (continue)

GoldSim	W/O	The Monte Carlo simulation software solution for dynamically modeling complex systems in engineering, science and business.	(GoldSim, 2017)
HLA	W/O	Developed by the Defense Modeling and Simulation Office (DMSO), USA, as a general-purpose architecture for distributed real-time simulations.	(Dahmann et al., 2016)
Hydrologists Workbench	W/O	A services-oriented scientific workflow framework for integrating hydrology models and data.	(Cuddy and Fitch, 2010)
HydroModeler	CF	An extension to HydroDesktop desktop application and adopts the OpenMI standard for model coupling	(Castronova et al., 2013)
ICMS	F	A framework for linking environmental models. Particularly used for catchment and associated ecosystem applications.	(Rizzoli et al., 1998)
IMA	W/O	A semantic framework and software design for enabling the transparent integration, reorganization, and discovery of natural systems knowledge.	(Villa, 2007)
IWRMS	GC	Integrated collection of water resource models (watersheds, rivers, lakes, estuaries) for supporting decision makers.	(Thurman et al., 2004)
Jcup	CF	Supports both the point-to-point communication algorithm and the multi-component data exchange.	(Arakawa et al., 2011)
Kepler	CF	A Java™ based environment for integrating disparate software components, such as "RTM" scripts with compiled "C" codes, or facilitating remote, distributed execution of models.	(Ludäscher et al., 2006)

Coupling tools/frameworks (continue)

LHEM	GC	Flexible landscape model structures that can be easily modified or extended for different goals.	(Voinov et al., 2004)
MCT	F	Consists of a set of small library and a set of Fortran90 modules that provide model interoperability solution through a simple API.	(Larson et al., 2005)
MIMOSA	W/O	A model simulation platform for building and running conceptual models.	(Müller, 2010)
MIMS	F	A software infrastructure or environment for constructing, composing, executing, and evaluating cross-media (ie.: air, water, soil, and animals) models	(MIMS, 2017)
MMS	CF	An integrated system of computer software framework built to support development, testing, and evaluation of physical-process algorithms and to facilitate integration.	(Leavesley et al., 1996)
ModCom	CF	The framework interfaces use binary standards and allows developers to implement the interfaces using a broad range of computer languages.	(Hillyer et al., 2003)
MpCCI	CF	An environment for direct coupling of different simulation source codes. It is a neutral standard for simulation code coupling and provides with multi-physics framework.	(Joppich et al., 2006)
NextFrAMES	CF	Built around a modeling XML standard which lets modelers to express the overall model structure and provides an API for dynamically linked plugins to represent the processes.	(Fekete et al., 2009)

Coupling tools/frameworks (continue)

OASIS	F	A system for running complex climate-ocean models on high performance computing systems.	(Valcke, 2013)
OMS	CF	Provides the ability to construct models and applications from a set of components on multiple platforms.	(David et al., 2002)
OOPS	F	A framework designed to support programming of concurrent scientific applications for parallel execution	(Sonoda and Travieso, 2006)
OpenMI	CF	A model linking technology that allows components running within a framework to be exchangeable. It consists of the OpenMI standard and GUI based model configuration editors.	(Gijssbers et al., 2002)
OpenPALM/ PALM	F	Framework for dynamic coupling of numerical models with high performance computing. The package comprises a GUI for model coupling, scheduling and parallelization.	(Lagarde et al., 2001)
PCSE	L/I	A Python package for building crop simulation models. It allows the environment to implement crop models' components and tools for reading ancillary data.	(Wit, 2017)
Pegasus	W/O	A scientific workflow that allows users to set-up and run multi-step computations and different environments including desktops, clusters, grids, and clouds.	(Deelman et al., 2005)

Coupling tools/frameworks (continue)

PETSc	L/I	A suite of data structures and routines for the scalable (parallel) solution of scientific applications modeled by partial differential equations.	(Balay et al., 2016)
PMML	L/I	The standard language for data mining models that use statistical techniques for learning patterns hidden in large volumes of historical data	(Grossman et al., 1999)
PRISM	GC	A portable and flexible infrastructure for assembling, compiling, running, monitoring and post-processing state-of-the-art models developed in the different European modeling groups.	(Guilyardi et al., 2003)
R (language)	L/I	The core of RTM is an interpreted computer language which allows branching, looping and modular programming. It can interface procedures written in C, C++, or FORTRAN.	(Hornik, 2017)
RECORD	F	Developed under the VLE environment, It integrates different time steps and spatial scales and proposes some standard formalisms used to model agro-ecosystems.	(Bergez et al., 2014)
RHEAS	F	Modular software framework that has been developed to facilitate the deployment of water resources simulations and the assimilation of remote sensing observations	(Andreadis et al., 2017)
Scup	F	A general-purpose coupler developed by Meteorological Research Institute (MRI) in Japan. It is like the OASIS coupler (it contains only data transfer and data transformation).	(Yoshimura and Yukimoto, 2008)

Coupling tools/frameworks (continue)

SEAMLESS	CF	An integrated framework for linking models, data and indicators. in support of environmental, economic and social analysis for agricultural systems. It based on the OpenMI standard.	(Van Ittersum et al., 2008)
SELES	F	A tool for building and running landscape dynamics models. It combines discrete events simulation with a spatial database.	(Fall and Fall, 2001)
SISS	F	An architecture and suite of tools for spatial data interoperability.	(Caradoc-Davies, 2017)
SME	F	An integrated environment for high performance spatial modeling. It links tools with advanced computing resources to support dynamic spatial modeling of complex systems.	(Maxwell et al., 2004)
Tarsier	CF	A Windows <sup>TM</sup> based modeling framework. it integrates several modules, highly customizable and comes with pre-developed data management, modeling, GIS and statistical modules.	(Watson et al., 1998)
Taverna	W/O	Domain-independent Workflow Management System, it is a suite of tools used to design and execute scientific workflows and aid in silico experimentation.	(Wolstencroft et al., 2013)
TDT	L/I	A library designed to transfer data between programs independently of platform and programming language. It mainly targets data intensive simulations.	(Linstead, 2012)

Coupling tools/frameworks (continue)

TIME	F	A model framework for developing, testing, linking, and calibrating environmental simulation models.	(Rahman et al., 2003)
Trident	W/O	A scientific workflow and workbench, it is set of tools based on the Windows Workflow Foundation for analyzing large and heterogeneous datasets.	(Barga et al., 2008)
VisTrails	W/O	An open-source scientific workflow that allows the combination of loosely-coupled resources, specialized libraries, grid and Web services.	(Bavoil et al., 2005)
WRF	GC	A next-generation mesoscale numerical weather prediction system designed for both atmospheric research and operational forecasting applications.	(Skamarock et al., 2001)

Tab. 3-Tools /frameworks references

Acronym	Web Link
AGROBASE GEN. II: Agronomic Base Generation II	<a href="http://www.agronomix.com">www.agronomix.com</a>
APSIM: Agricultural Production Systems Simulator	<a href="http://www.apsim.info">www.apsim.info</a>
ARAMS: The Adaptive Risk Assessment Modeling System	<a href="http://www.ercd.usace.army.mil/Media/Fact-Sheets/Fact-Sheet-Article-View/Article/500113/adaptive-risk-assessment-modeling-system-arams/">http://www.ercd.usace.army.mil/Media/Fact-Sheets/Fact-Sheet-Article-View/Article/500113/adaptive-risk-assessment-modeling-system-arams/</a>
ARIES: ARTificial Intelligence for Ecosystem Services	<a href="http://aries.integratedmodelling.org/">http://aries.integratedmodelling.org/</a>
BASINS: Better Assessment Science Integrating Point and Nonpoint Sources	<a href="https://www.epa.gov/exposure-assessment-models/basins">https://www.epa.gov/exposure-assessment-models/basins</a>
BFG: Bespoke Framework Generator	<a href="https://source.ggy.bris.ac.uk/wiki/GENIE_BFG">https://source.ggy.bris.ac.uk/wiki/GENIE_BFG</a>
BPEL: Business Process Execution Language	<a href="https://docs.oasis-open.org/wsbpel/2.0/wsbpel-v2.0.pdf">docs.oasis-open.org/wsbpel/2.0/wsbpel-v2.0.pdf</a>
CCA: Common Component Architecture	<a href="http://www.cca-forum.org">www.cca-forum.org</a>
CCMP: Chesapeake Community Modeling Program	<a href="http://ches.communitymodeling.org">ches.communitymodeling.org</a>
C-Coupler: Chinese Community Coupler	-/-
CESM: The Community Earth System Model (Ex. CCSM: Community Climate System Model)	<a href="http://www.cesm.ucar.edu">www.cesm.ucar.edu</a>
CHPS: Community Hydrology Prediction System	<a href="http://www.nws.noaa.gov/ohd/hrl/chps">www.nws.noaa.gov/ohd/hrl/chps</a>
CHyMP: Community Hydrology Modeling Platform	<a href="http://www.cuahsi.org">www.cuahsi.org</a>
CMP: Common Modeling Protocol	-/-
CSDMS: Community Surface Dynamics Modeling System	<a href="http://csdms.colorado.edu">csdms.colorado.edu</a>
DDB: Distributed Data Broker	<a href="https://people.eecs.berkeley.edu/~sklower/DB/paper.html">https://people.eecs.berkeley.edu/~sklower/DB/paper.html</a>
Delft-FEWS: Delft Flood Early Warning System	<a href="http://www.deltares.nl">www.deltares.nl</a>
Delta Shell: Delta Shell	<a href="https://oss.deltares.nl/web/delta-shell">https://oss.deltares.nl/web/delta-shell</a>

DIAS: Dynamic Information Architecture System	-/-
DSSAT: Decision Support System for Agrotechnology Transfer	<a href="http://dssat.net">http://dssat.net</a>
EnSym: Environmental Systems Modelling Platform	<a href="https://ensym.dse.vic.gov.au">https://ensym.dse.vic.gov.au</a>
ESMF: Earth System Model Framework	<a href="http://www.earthsystemmodeling.org">www.earthsystemmodeling.org</a>
EvoLand/ENVISION: Environmental Vision	<a href="http://envision.bioe.orst.edu">http://envision.bioe.orst.edu</a>
FluidEarth: Fluid Earth	<a href="https://fluidearth.net">https://fluidearth.net</a>
FMS: Flexible Modeling system	<a href="https://www.gfdl.noaa.gov/fms/">https://www.gfdl.noaa.gov/fms/</a>
FRAMES: Framework for Risk Analysis in Multimedia Environmental Systems	<a href="http://mepas.pnnl.gov/framesv1/sum3ug.stm">mepas.pnnl.gov/framesv1/sum3ug.stm</a>
FrAMES: Framework for Aquatic Modeling of the Earth System	<a href="http://terra.whrc.org/denitrification/WS1/WS1models/FrAMES.pdf">http://terra.whrc.org/denitrification/WS1/WS1models/FrAMES.pdf</a>
FSE: FORTRAN Simulation Environment	-/-
GCF: General Coupling Framework	-/-
GME (1): Geospatial Modeling Environment	<a href="http://www.spatialecology.com">www.spatialecology.com</a>
GME (2): Generic Modeling Environment	<a href="http://www.isis.vanderbilt.edu/projects/GME">http://www.isis.vanderbilt.edu/projects/GME</a>
GMS/WMS/SMS: Groundwater, Watershed, Surface-water Modeling System	<a href="http://www.aquaveo.com">www.aquaveo.com</a>
GoldSim: Golder Simulation	<a href="http://www.goldsim.com">www.goldsim.com</a>
HLA: High Level Architecture	-/-
Hydrologists Workbench: Hydrologists Workbench	<a href="http://www.mcs.anl.gov/~jacob/ehwb/index.html">http://www.mcs.anl.gov/~jacob/ehwb/index.html</a>
HydroModeler: Hydrologic Modeler	<a href="http://www.HydroDesktop.org">www.HydroDesktop.org</a>
ICMS: Integrated Component Modelling System	<a href="http://www.clw.csiro.au/products/icms/">www.clw.csiro.au/products/icms/</a>
IMA: Integrating Modelling Architecture	-/-
IWRMS: Integrated Water Resource Modeling System	<a href="https://www.witpress.com/Secure/elibrary/papers/BF204/BF204010FU.pdf">https://www.witpress.com/Secure/elibrary/papers/BF204/BF204010FU.pdf</a>
Jcup: Japanese coupler	<a href="https://github.com/Jcuplib/jcup/wiki">https://github.com/Jcuplib/jcup/wiki</a>

Kepler: KEPLER	<a href="https://kepler-project.org/">https://kepler-project.org/</a>
LHEM: Library of Hydro-Ecological models	-/-
MCT: The Model Coupling Toolkit	<a href="http://www.mcs.anl.gov/research/projects/mct/">www.mcs.anl.gov/research/projects/mct/</a>
MIMOSA: Migration MOdelling for Statistical Analyses	<a href="http://mimosa.sourceforge.net/documentation.html">http://mimosa.sourceforge.net/documentation.html</a>
MIMS: The Multimedia Integrated Modeling System	<a href="http://mimsw.sourceforge.net/">http://mimsw.sourceforge.net/</a>
MMS: Modular Modeling System	<a href="https://pubs.usgs.gov/of/1996/0151/report.pdf">https://pubs.usgs.gov/of/1996/0151/report.pdf</a>
ModCom: Modular Communications	-/-
MpCCI: The Mesh based parallel Code Coupling Interface	<a href="http://www.mpcci.de">www.mpcci.de</a>
NextFrAMES: Next-generation Framework for Aquatic Modeling of the Earth System	<a href="http://terra.whrc.org/denitrification/WS1/WS1models/FrAMES.pdf">http://terra.whrc.org/denitrification/WS1/WS1models/FrAMES.pdf</a>
OASIS: Ocean, Atmosphere, Sea, Ice, Soil	<a href="http://www.cerfacs.fr/3-26568-OASIS.php">www.cerfacs.fr/3-26568-OASIS.php</a>
OMS: Object Modelling System	<a href="http://oms.colostate.edu">http://oms.colostate.edu</a>
OOPS: Object-Oriented Parallel System	-/-
OpenMI: Open Modeling Interface	<a href="http://www.openmi.org">www.openmi.org</a>
OpenPALM: Projet D'Assimilation par Logiciel Multi-methodes	<a href="http://www.cerfacs.fr/globc/PALM_WEB/">www.cerfacs.fr/globc/PALM_WEB/</a>
PCSE: Python Crop Simulation Environment	<a href="http://pcse.readthedocs.io">http://pcse.readthedocs.io</a>
Pegasus-WMS: Planning for Execution in Grids - Workflow Management System	<a href="https://pegasus.isi.edu/">https://pegasus.isi.edu/</a>
PETSc: Portable, Extensible Toolkit for Scientific Computation	<a href="https://www.mcs.anl.gov/petsc/">https://www.mcs.anl.gov/petsc/</a>
PMML: Predictive Model Markup Language	<a href="http://www.dmg.org">www.dmg.org</a>
PRISM: Partnership for Research Infrastructures in Earth Systems Modeling	<a href="https://www.dkrz.de/daten-en/wdcc/projects_cooperations/past-projects/prism-1/prism-detailed-documentation">https://www.dkrz.de/daten-en/wdcc/projects_cooperations/past-projects/prism-1/prism-detailed-documentation</a>

R: R	<a href="http://r-project.org">r-project.org</a>
RECORD: REnovation and COORDination of agro-ecosystems modelling	<a href="https://www6.inra.fr/record_eng/">https://www6.inra.fr/record_eng/</a>
RHEAS: Regional Hydrologic Extremes Assessment System	<a href="http://rheas.readthedocs.io/en/latest/">http://rheas.readthedocs.io/en/latest/</a>
Scup: Simple Coupler	<a href="http://www.mri-jma.go.jp/Project/1-21/1-21-1/scup-en.htm">http://www.mri-jma.go.jp/Project/1-21/1-21-1/scup-en.htm</a>
SEAMLESS: System for Environmental and Agricultural Modelling: Linking European Science and Society	<a href="http://www.seamless-ip.org">http://www.seamless-ip.org</a>
SELES: Spatially Explicit Landscape Event Simulator	<a href="https://greatlakesinform.org/decision-tools/355">https://greatlakesinform.org/decision-tools/355</a>
SISS: Spatial Information Services Stack	<a href="https://www.seegrid.csiro.au/wiki/Siss/WebHome">https://www.seegrid.csiro.au/wiki/Siss/WebHome</a>
SME: Spatial Modelling Environment	<a href="http://likbez.com/AV/Spatial_Modeling_Book/2/index.html">http://likbez.com/AV/Spatial_Modeling_Book/2/index.html</a>
Tarsier: Tarsier	<a href="http://ecoviz.csumb.edu/wiki/index.php/Tarsier">ecoviz.csumb.edu/wiki/index.php/Tarsier</a>
Taverna: Taverna	<a href="http://www.taverna.org.uk">www.taverna.org.uk</a>
TDT: a library for Type Data Transfer	<a href="https://www.pik-potsdam.de/research/transdisciplinary-concepts-and-methods/tools/tdt">https://www.pik-potsdam.de/research/transdisciplinary-concepts-and-methods/tools/tdt</a>
TIME: The Invisible Modelling Environment	<a href="https://toolkit.ewater.org.au/Tools/TIME">https://toolkit.ewater.org.au/Tools/TIME</a>
Trident: Trident	<a href="http://tridentworkflow.codeplex.com">tridentworkflow.codeplex.com</a>
VisTrails: Visual Trails	<a href="http://www.vistrails.org">www.vistrails.org</a>
WRF: Weather Research and Forecasting	<a href="http://www.wrf-model.org/index.php">www.wrf-model.org/index.php</a>

## 2.3. Integrated environmental modelling communities

The development of research and user communities becomes an important requirement for a better understanding of environmental processes and systems. Furthermore, the importance of the community and human dimension in the

development of integrative modeling has the potential to assist communities in adapting to increasingly complex environmental stresses. Communities of practice are emerging, attempting to address this challenge.

Currently, the initiatives and their communities are relatively at their early stage. Some models have been released in open source form with a view of building-up a large user community. Tab. 4, Tab. 5, Tab. 6 and Tab. 7 list some of the leading communities built around integrated environmental modeling initiatives and framework/tools.

Tab. 4- Coupling frameworks/tools-based communities

Community	Web Link
CCA Forum	<a href="http://ccaforum.com">ccaforum.com</a>
Consortium of Universities for the Advancement of Hydrologic Science (CUACHI)	<a href="http://cuahsi.org">cuahsi.org</a>
Community Surface Dynamics Modeling System (CSDMS)	<a href="http://csdms.colorado.edu">csdms.colorado.edu</a>
OpenWEB (FluidEarth)	<a href="http://fluidearth.net">fluidearth.net</a>
Integrated Environmental Modelling Hub (iemHUB)	-/-
Open Geospatial Consortium (OGC)	<a href="http://opengeospatial.org">opengeospatial.org</a>
Partnership for Research Infrastructures in Earth Systems Modeling (PRISM)	<a href="http://dkrz.de/daten-en/wdcc/projects_cooperations/past-projects/prism">dkrz.de/daten-en/wdcc/projects_cooperations/past-projects/prism</a>
SEAMLESS Association	<a href="http://seamlessassociation.org">seamlessassociation.org</a>
Chesapeake Community Modelling Program (CCMP)	<a href="http://ches.communitymodeling.org">ches.communitymodeling.org</a>
The Earth System Modelling Framework (ESMF)	<a href="http://earthsystemmodeling.org">earthsystemmodeling.org</a>
Framework for Risk Analysis of Multi-Media Environmental Systems (FRAMES - 3MRA)	<a href="http://epa.gov/athens/research/modeling/3mra.html">epa.gov/athens/research/modeling/3mra.html</a>
OpenMI Association	<a href="http://openmi.org">openmi.org</a>
FluidEarth	<a href="http://fluidearth.net">fluidearth.net</a>
The Kepler Project	<a href="http://kepler-project.org/">kepler-project.org/</a>

Community Earth System Model (CESM)	<a href="http://www2.cesm.ucar.edu">www2.cesm.ucar.edu</a>
The Model Coupling Toolkit (MCT)	<a href="http://mcs.anl.gov">mcs.anl.gov</a>
Multimedia Integrated Modelling System (MIMS)	<a href="http://mimsw.sourceforge.net">mimsw.sourceforge.net</a>
Community Modeling and Analysis System (CMAS)	<a href="http://cmascenter.org">cmascenter.org</a>
OpenPALM	<a href="http://cerfacs.fr/globc/PALM_WEB">cerfacs.fr/globc/PALM_WEB</a>
EPA's (Environmental Protection Agency) modelling community	<a href="http://epa.gov/modeling">epa.gov/modeling</a>

Tab. 5- Models/software packages communities: Crop

Agricultural Production Systems Simulator (APSIM)	<a href="http://apsim.info">apsim.info</a>
Decision Support System for Agrotechnology Transfer Foundation (DSSAT)	<a href="http://dssat.net">dssat.net</a>
Modeling European Agriculture with Climate Change for food Security (MACSUR)	<a href="http://macsur.eu">macsur.eu</a>
The Agricultural Model Inter-comparison and Improvement Project (AgMIP)	<a href="http://agmip.org">agmip.org</a>
Wheat initiative	<a href="http://wheatinitiative.org">wheatinitiative.org</a>

Tab. 6- Models/software packages communities: Hydrology

Community	Web Link
CUAHSI-HIS	<a href="http://his.cuahsi.org/wofws.html">his.cuahsi.org/wofws.html</a>
The Community Hydrologic Modelling Platform (CHyMP)	<a href="http://cuahsi.org">cuahsi.org</a>
Hydrology Thematic Exploitation Platform (Hydrology TEP)	<a href="http://hydrology-tep.eo.esa.int">hydrology-tep.eo.esa.int</a>
MIKE-SHE Community	<a href="http://mikepoweredbydhi.com">mikepoweredbydhi.com</a>
Community Sediment Transport Modeling System (CSTMS)	<a href="http://woodshole.er.usgs.gov/project-pages/sediment-transport">woodshole.er.usgs.gov/project-pages/sediment-transport</a>
eWater	<a href="http://toolkit.ewater.org.au">toolkit.ewater.org.au</a>
Soil and Water Assessment Tool (SWAT)	<a href="http://swat.tamu.edu">swat.tamu.edu</a>

Tab. 7- Models/software packages communities: Other

Community	Web Link
The Comprehensive R Archive Network (CRAN)	<a href="http://cran.r-project.org">cran.r-project.org</a>
Geographic Resources Analysis Support System (GRASS)	<a href="http://grass.osgeo.org">grass.osgeo.org</a>
MapWindow	<a href="http://mapwindow.org">mapwindow.org</a>
Deltares Open Source and Software	<a href="http://oss.deltares.nl">oss.deltares.nl</a>
International Environmental modelling & Software Society (iESs)	<a href="http://iemss.org">iemss.org</a>

### 3. Discussion and implications

In order to be coupled, models must be interoperable, a property often referred to but missing a single and precise definition. For instance, Wileden and Kaplan, (1999) defined this as the capability of two or more programs to share and process information irrespective of their implementation language and platform (Wileden and Kaplan, 1999). Similarly, Buehler and McKee (1999) defined interoperable geo processing as “the ability of digital systems to: (i) freely exchange all kinds of spatial information about the Earth and about objects and phenomena on, above, and below the Earth’s surface; and (ii) cooperatively, over networks, run software capable of manipulating such information.” (Buehler and McKee, 1996). Both definitions apply to computer programs, hardware, and data file formats.

Models and their respective data must be interoperable with both spatial and temporal scale. If a scale difference cannot be resolved, then the models cannot be meaningfully coupled. Although the models may share information, if the models’ scales are different, the results from the coupled system are meaningless. In such cases, an intermediate program is required to reconcile the scales. For example, two models may assume the same data type with the same dimensions and extends. However, if the output is in the time unit but one is in minute and the other one is in month, a temporal scale conversion for interoperability is required. Similarly, if the spatial scale is different, a spatial conversion is required (2009, Kumar et al., 2006).

Due to the substantial number of available models and practical tools, and the different approaches, e.g., from empirical to mechanistic, that characterize them, choosing of a suitable model to be coupled and the specific method of data processing may be difficult. Moreover, a lack of knowledge on the domain heterogeneity can make its application entirely misleading.

Often, computer resources encompass a restrictive factor for such combinations. Nevertheless, reasonable computational time and precision can be achieved when simulated processes are not overloaded (i.e. in the Random-Access-Memory (RAM) or Central Processing Unit (CPU)). In addition to hardware resources, both programming languages and framework of combination play a key role in managing the available resources. These aspects are purely computer science-oriented criteria and may represent a serious barrier to the source models to be combined.

Among the available methodologies and frameworks for coupling, many factors should be considered prior the selection of an appropriate one. These factors include the nature and relative scale of the crop system, basin characteristics, data and information availability, method requirements, time constraints for producing an assessment and the required accuracy. In some cases, process selection is a context shaped approach. Therefore, the process should be transparent, where the assumptions, simplifications, and other limitations are clearly indicated. This would assist in validating the results with observation data. The process needs also to be adaptive, where new or improved information can be incorporated.

The first criterion for modeler when selecting models to be coupled should be the end purposes, followed by the selection of the adequate compromise between precision and ease-of-use for investigating the models' assumptions and qualifications. This implies that the addressed user should have a comprehensive overview on the selected models' purposes, metrics, capabilities and field of validity. Then, the user has to consider the biophysical cycles that have to be modeled, along with the crop and

hydrologic cycle. The greater is the number of simulated processes, the larger is the complexity of the resulting coupled model.

Going on through the choice of models, specific purposes regarding the investigated agro-hydrologic system and climatic regions, such as their ecological relevance, economic importance, expected risks, etc. should be defined. Hence, it is necessary to refer to the geographic regions where models have been already applied. Successful studies for assessments and analyses serve as guides towards most suitable planning for coupling, especially those targeting climate changes and adaptation issues. Literature offers several models' reviews, mostly focused on topics of specific interests, such as the description of general approaches and evaluation, inter-comparison of models' performance, forecasts, and gaps analysis

---

*CHAPTER II:*

*REVIEW OF COUPLED  
HYDROLOGIC AND CROP  
GROWTH MODELS*

---

## CHAPTER II: REVIEW OF COUPLED HYDROLOGIC AND CROP GROWTH MODELS

### 1. Introduction

Hydrologic and crop growth numerical modeling has progressed over the last decades, where the scientific modeler community has derived to recognize that various aspects are complementary between hydrologic and crop systems. Debates and issues on food security, environmental degradations and climate change have raised the need for integrated simulation models to cope with issues of sustainable agriculture production tandem with resources scarcity and climate stresses. A proper answer to the question of how water can be used efficiently to produce more is therefore needed (White et al., 2011b). Furthermore, agricultural pricing and policies have a high impacts on farmers' incentives to have a high control of their cropping systems (Siad et al., 2017). Being major user of water, agriculture is a potential adequate field to study water use efficiency (Jia et al., 2011).

Agricultural water use for crops relies on several factors, such as: topography, lithology, management practices, soil, climatic conditions, type of crop, etc. Knowledge of these parameters allows to estimate crop-water requirement and for establishing cropping management procedures. Water requirements by agricultural crops can be determined locally at the field. Nevertheless, while all these processes being observed at small spatial scales, they are mainly conditioned by rainfall and its distribution and redistribution at the basin scale. To date, hydrological practices had been developed to their greatest advancement in the study of large catchments for water resources purposes and they had a limited implication in agriculture (Jia et al., 2011). With an increasing importance of improving low agricultural productivity in marginal regions, where capital investments are not beneficial (subsistence activity), water harvesting is the determinant of agricultural production. Thus, a profound understanding of hydrological conditions is essential to exploit soil moisture opportunities (Antonelli et al., 2015).

This chapter presents a review of coupled crop growth and hydrologic models' studies. It starts by introducing general concepts related to hydrologic, crop growth and coupling models, and coupling computer models. Then after, a synthesis of literature studies comprising coupled hydrologic and crop growth applied for different purposes. In addition, we provided some considerations and implications.

## 2. Concepts and notions

The conception of environmental modeling deals with the relationships of water-climate-soil-plant (White et al., 2011c, Iacobellis et al., 2002), and includes temporal and spatial features (Meiyappan et al., 2014). Behavior of each feature is controlled by its own components (Jajarmizadeh et al., 2012). Accordingly, models are a simplified representations of the real world (Anothai et al., 2008). Models can be either physical, electrical analogue, or mathematical (Gutzler et al., 2015). The physical and analogue models have been very important in the past (Refsgaard, 1996). Nowadays, the mathematical group of models is by far the most easily and universally applicable, the most widespread and rapidly developing with regards to scientific basis and application (van Kraalingen et al., 2003).

### 2.1. Crop growth modeling

Crop models are simulations that help estimating crop yields as a function of weather, soil conditions, and the applied management practices (Hoogenboom et al., 2002). There are several types of models that have been developed over the years. They can be classified into various groups or types, ranging from empirical to explanatory models (Hoogenboom, 1999).

Empirical models are based on direct descriptions of observed data, expressed as regression equations and used for yield estimation. This approach analyzes data and fits an equation, or a set of equations, to the data. These models have no information on the mechanisms behind the outputs (Phakamas et al., 2013). In contrast, mechanistic models do explain not only the relationships between weather parameters

and crop yields, but also the mechanisms that control these relationships (Bannayan et al., 2003).

In Stochastic models, each output is attached to a probability element. For each set of inputs, different outputs are given along with probabilities. These models define a state of dependent variable at a given rate (Etkin et al., 2008). Explanatory models consist of quantitative description of the mechanisms that cause the behavior. In such models, the processes are quantified separately, and then integrated into the entire system (Hoogenboom, 1994).

Among the successfully used models are the EPIC (Williams, 1990), CERES-maize (Bao et al., 2017), ALMANAC (Kiniry et al., 2005), CROPSYST (Stöckle et al., 2003), WOFOST (van Diepen et al., 1989) and ADEL (Fournier et al., 2003) for simulating maize growth and yield. The SORKAM (Rosenthal et al., 1989), SorModel (Arora, 1982), SORGF (Wiegand and Richardson, 1984), and ALMANAC used for sorghum crop management. CERES-pearl millet model (Santos et al., 2016), CROPSYST, and PM Models (Boylan and Russell, 2006) used for simulating of pearl millet genotypes across the globe. Similarly, the PNUTGRO (Hoogenboom et al., 1992) is used for groundnut, CHIKPGRO (Singh and Virmani, 1996) for chick pea, WTGROWS (Sehgal and Sastri, 2005) for wheat, SOYGRO (Hoogenboom et al., 1990) for soybean, QSUN (Schnable et al., 2009) for sunflower, and GOSSYM(Boone et al., 1993) and COTONS (Jallas et al., 2000) for cotton. Those are some of the models in use for meeting the requirements by farmers, scientists, and decision makers at present.

## 2.2. Hydrologic modeling

Hydrologic models are developed for estimating, predicting and managing water distribution and fluxes, at the soil-atmosphere interface, as a function of various parameters that are used for describing soil and watershed characteristics (e.g. (Manfreda et al., 2005, Gioia et al., 2011)).The inputs generally required are atmospheric data (e.g. rainfall and temperature) while the model parameterization

includes watershed characteristics like the topographical relief, geomorphology, vegetation cover, soil and bedrock properties (Fig. 8).

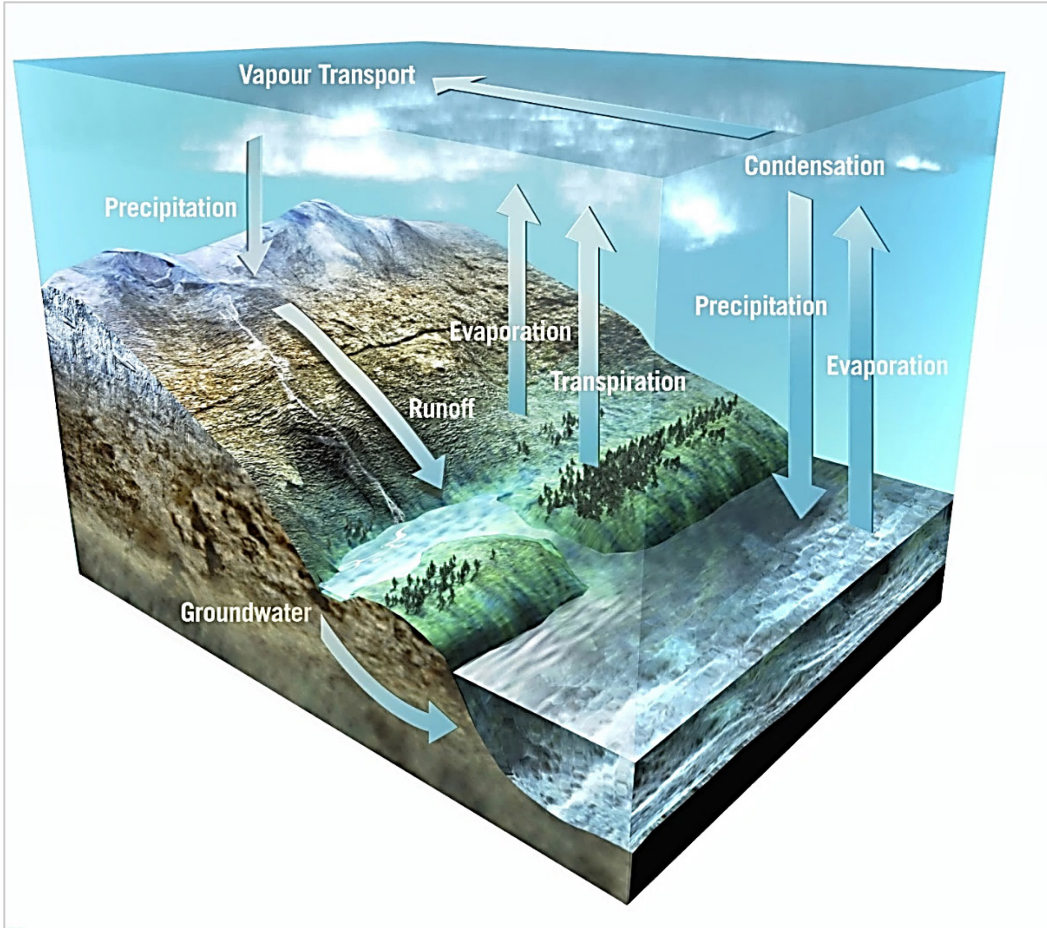

Fig. 8- Example of catchment with water distribution (ESA/AOES-Medialab, 2004b)

When restricted to land surface processes, they are referred to as Rainfall-Runoff models and are often based on a conceptual representation of physical processes (Iacobellis et al., 2015). In general, they can be classified as lumped or distributed models (e.g. (Milella et al., 2012)), depending on the spatial discretization of parameters. In lumped model, the entire watershed is taken as a single unit and the On the other hand, distributed models can deal with space distributed quantities by

dividing the catchment into subunits, usually square cells or triangulated irregular network, so that the parameters, inputs and outputs can vary spatially.

A large number of models with different applications ranges, from small catchments to global models, has been developed, such as DHSVM (Wigmosta et al., 2002), MIKE-SHE (Refsgaard and Storm, 1995), TOPLATS (Bormann, 2006), WASIM-ETH (Schulla and Jasper, 2007), SWAT (Santhi et al., 2001), PRMS (Heckerman et al., 2007), SLURP (Barr et al., 1997), HBV (Lindstrom et al., 1997), LASCAM (Viney and Sivapalan, 2001), IHACRES (Croke et al., 2005), DREAM (Manfreda et al., 2005), etc., where each model has got its own unique characteristics and respective applications. The model choice and implementation are basically constraint by data availability (e.g. gauged or ungauged catchment), and modeling purpose such as streamflow and flood forecasting, water resource management, evaluation of water quality, erosion, nutrient and pesticide circulation, etc. (Manfreda et al., 2015, Di Modugno et al., 2015, Gorgoglione et al., 2016).

### 2.3.Complementarily of simulation processes

The role of hydrological modeling and the collection of hydrological data in the efficiency of crop production is to provide accurate soil moisture distribution in space and time accounting for basin scale water dynamics (Dokoohaki et al., 2016b, Balenzano et al., 2013, Iacobellis et al., 2013). Indeed, rainfall amount and its space-time distribution determine the quantity of water that reaches the land's surface. Temperature, humidity, vegetation cover (i.e. type, amount and distribution) determine the proportion of water that evaporates. Vegetation, soil conditions, and topography determine the quantity of water that infiltrates into the soil vs. that runs on the ground surface (Gioia et al., 2014). It is the interactions among these complex processes that define the quantity of water effectively available for crops in the rhizosphere (Fig. 9).

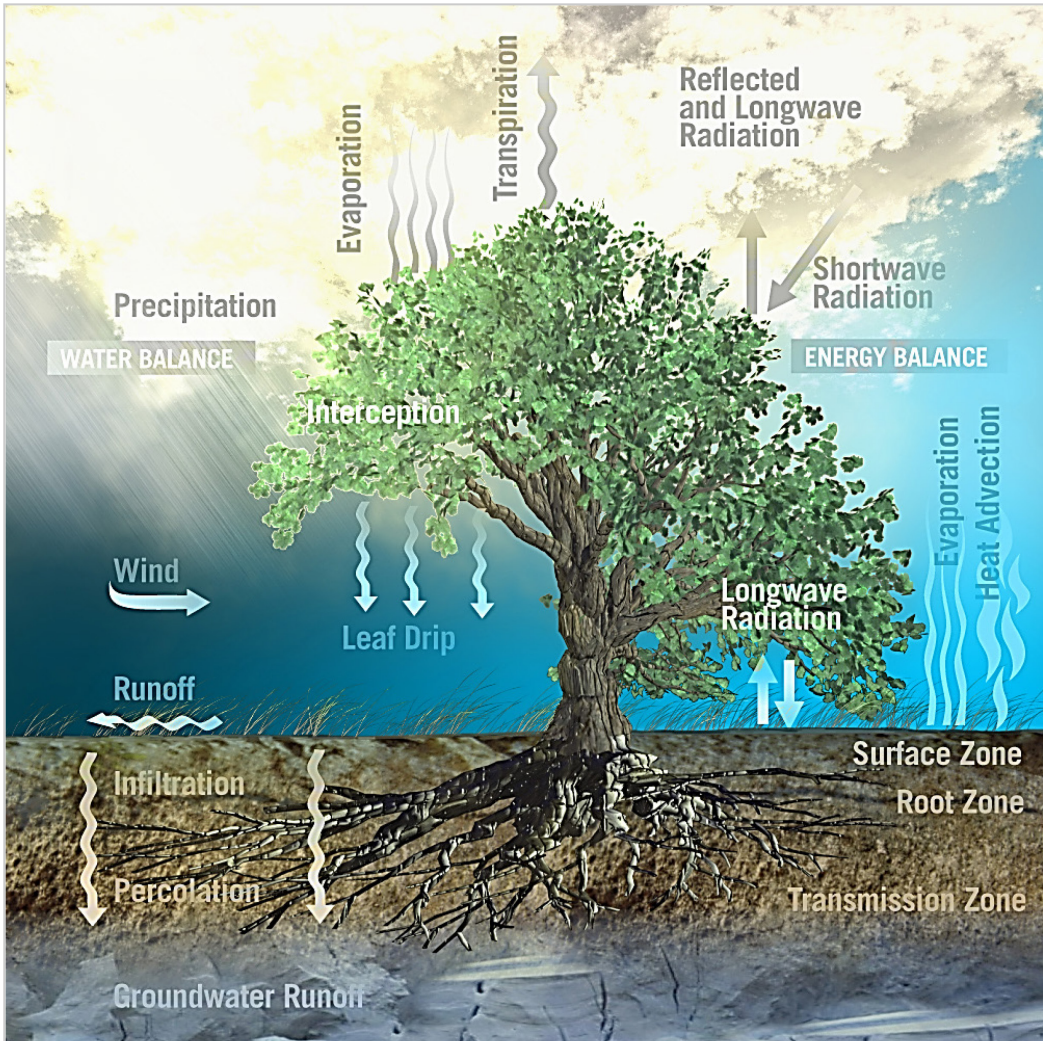

Fig. 9- Soil water balance interaction with vegetation (ESA/AOES-Medialab, 2004a)

Vegetation affects water balance by evapotranspiration (ET) and interception. Thus, canopy properties such as the leaf area index (LAI) and the rooting depth, are obtained offline (externally), and are considered as parameters in most physically based hydrologic models (McNider et al., 2015b, Gigante et al., 2009). LAI estimates provide an indication of vegetation growth cycle and of the plant activity in terms of water transpiration. Nevertheless, keeping LAI constant throughout a model simulation may lead to errors in the model results. LAI may also be treated as an input variable,

being regularly updated by means of earth observation products (Milella et al., 2012, Balacco et al., 2015). On the other hand, exploiting crop growth models, the hydrologic model could be enhanced with a module able to simulate vegetation development. Crop growth models, which accurately model soil water flow processes, should be preferred compared to other method to obtain vegetation stats (Betts, 2005). Nevertheless, they can be improved by a proper modeling of water flow distribution for a better estimation of ET's rates. Since all these processes are represented in hydrologic models, the coupling of hydrologic and crop growth models can be expected to be beneficial for both simulations (Manfreda et al., 2010).

## 2.4. Coupling models

Coupling is used in the context of feedbacks between various processes. It does refer to physics, but it is conducted on software-development base with numerical implications. There several methods of coupling models, they range from simple hand-mad data exchange to automated framework of integration as follow:

1. **Sequential coupling:** Models are completely decoupled
2. **Loose coupling:** Models do exchange I/O data
3. **Shared coupling:**
  - a. **Unified GUI:** Models share graphical user interface (GUI)
  - b. **Shared data:** Models share I/O database
4. **Embedded:** One model is completely contained in the other (usually as a subroutine)
5. **Integrated:** Models are merged at the code source level in one coherent model.
6. **Framework:** Using an overall modeling framework, the models are coupled using a third-part tool commonly called "Coupler" based on a combination of the previous methods.

The level of coupling refers to the degree to which model variables depend upon each other. In high-level coupling (i.e. Embedded, Integrated) each component and its linked one must be presented in order for code or framework to be executed. At the

same time, low level coupling (i.e. shared and Loose coupling) allows components to be autonomously managed and to communicate among them. In a completely decoupled coupling (i.e. Sequential coupling), components operate separately and independently.

## 2.5. Open- and Closed-source models

The notion of openness/closeness of a source can be applied either for the code source of a model and/or its data. Flexibility uses, and modifications, of closed-source models are predetermined by the creator(s), which is subjected to copyright and limit their accessibility and modification. In other hand, open source allows more freedom in modification, reproduction and use according to needs. Also, open source, with the possibility to change their code, develop more rapidly. Generally, we may define three level of openness to third party models:

- **Open Source:** A completely open source code.
- **Partially Open Source:** part of the source code is restricted.
- **Close Source:** An entirely restricted source code.

And three other level for third party data:

- **Heterogeneous:** No restriction for third party data source.
- **Partially Heterogeneous:** Some data sources are restricted.
- **Homogeneous:** Only pre-determined data source is accepted.

These characteristics must be considered for model development based on coupling. An integrated method offers a highly cohesive system but makes its maintenance and upgradability harder (for instance, if new versions of the legacy models are released). In contrast, less invasive method offers easier maintenance and more homogeneity but with weak cohesiveness (Fig. 10).

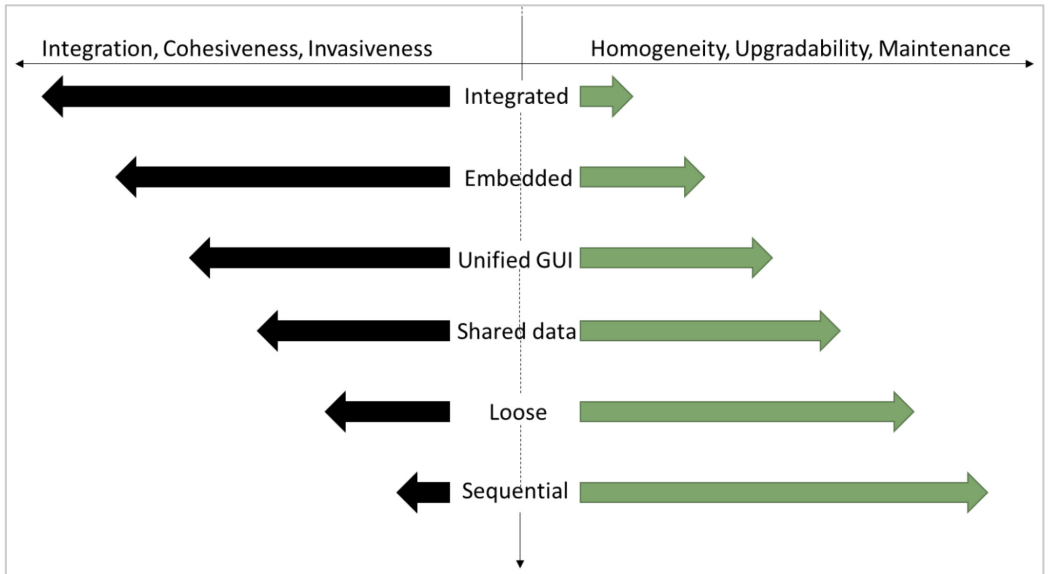

Fig. 10- Compromise between methods and integration

### 3.Review of coupled hydrologic and crop growth model

Coupling hydrologic and crop model's studies are relatively scarce and still at its early development stage. Nevertheless, it is an important work for scientific modeler community dealing with sustainable water resources management for crop system improvement. The principal objectives of the reviewed studies (Tab. 8) concern a better quantification of ET, CO<sub>2</sub>, water and chemical flux estimation with dynamic vegetation. For this reason, exchanges between atmosphere– surface–subsurface water fluxes need to be complemented with crop development and other physiological processes.

The developed models have been parameterized for a given target crop(s) according to area extend and/or relevance for the study focus. All studies' results show that hydrologic processes are sensitive to changes led by the incorporation of crop dynamics in the hydrologic models and significantly improve fluxes estimation (compared to the original hydrologic models). It was concluded (case study related) that improving the estimation of energy, ET, CO<sub>2</sub>, pollutants and water fluxes over croplands is achieved through a more accurate description of vegetation dynamics.

In other hand, with the numerous crop models available and their different levels of sophistication, water requirement and availability are basic inputs. Increased accuracy of soil hydrology better the understanding of temporal dynamics as a function of agricultural production and inter-seasonal plant physiological changes, while at the same time improves irrigation practices.

Tab. 8- List of coupled hydrologic and crop models' studies

Note: Not all studies do use the nomenclature shown previously in “**Error! Reference source not found..Error! Reference source not found.**” for describing the coupling method. In such case, the coupling method is drawn from the description of the coupling process when enough information is provided.

Method	Models			Description	Study focus	Reference study
	Hydrology	Crop	Coupled			
-/-	Built from scratch	from scratch	Built from scratch	-/-	Coupling based on a predetermined empirical relationship.	Seasonality and energy balance effect on rice. (Maruyama and Kuwagata, 2010)
Integrated	CHAIN-2D	EPIC	-/-	Models' subroutines/functions coded with FORTRAN 90.	Simulation of furrow irrigation and crop yield.	(Wang et al., 2014)
Loose coupling	CMF	PMF	CMF-PMF	Follow recommendation of (Perkel, 2015).	Effect of CO2 on grassland	(Kellner et al., 2017)
Integrated	DRAINMOD	DSSAT	DRAINMOD–DSSAT	Modular codes integration.	Integrated agricultural system modelling.	(Negm et al., 2014)
Integrated	HYDRUS 1D	DSSAT	-/-	Simplified version of HYDRUS 1D integrated to DSSAT Code source.	Simulations of Soil Water Dynamics in the Soil-Plant-Atmosphere System.	(Shelia et al., 2017)

## List of coupled hydrologic and crop models' studies (continue)

Integrated	HYDRUS 1D	EPIC	-/-	Models' subroutines/functions coded with FORTRAN 90.	Irrigation water salinity impacts assessment.	(Wang et al., 2017)
Embedded	HYDRUS 1D	EPIC based	-/-	HYDRUS 1D is the host model and the SWAT's EPIC crop module is simplified and added.	Impacts of groundwater balance on cotton growth.	(Han et al., 2015)
Integrated	HYDRUS 1D	PS123	WHCNS	The models are integrated in whole WHCNS modelling framework	Water and nitrogen management.	(Liang et al., 2016)
Framework	HYDRUS 1D	WOFOST	-/-	OMS V.3 framework	Agricultural water management.	(Zhang et al., 2012)
Integrated	HYDRUS 1D	WOFOST	-/-	Modules and functions integration.	Irrigation modeling of wheat cultivation.	(Zhou et al., 2012)
Loose coupling	JULES	InfoCrop	-/-	One-ways data exchange	Estimation of evapotranspiration	(Tsarouchi et al., 2014)
Integrated	JULES	SUCROS	JULES-SUCROS	Modular incorporation of derived SUCROS model to JULES.	Crop growth simulation.	(Van den Hoof et al., 2011)

## List of coupled hydrologic and crop models' studies (continue)

Framework	MIKE-SHE	DAISY	DAISY-MIKE SHE	OpenMI framework	Nitrate leaching.	(Thirup, 2013, Thirup et al., 2014)
Integrated	MIKE-SHE	DAISY	-/-	Hard code integration of models.	Macropore flow and transport processes modeling.	(Skovdal Christiansen et al., 2004)
Integrated	MIKE-SHE	DAISY	-/-	Hard code integration of models.	Integration of remote sensing in agro-hydrologic modeling.	(Boegh et al., 2004a)
Loose coupling	ORCHIDEE	STICS	-/-	One-way data exchange with shared inputs.	Croplands influence water and carbon balance.	(De Noblet- Ducoudré et al., 2004)
Embedded	RZWQM	DSSAT	RZWQM2	Wrapping approach for model integration.	Presentation of the RZWQM2	(Ma et al., 2012)
Embedded	RZWQM	DSSAT- CERES	RZWQM- CERES	CERES-Maize added as a module to RZWQM.	Maize crop growth and yield modelling.	(Ma et al., 2006)
Embedded	RZWQM	DSSAT- CROPGRO	RZWQM- CROPGRO	CROPGRO added as a module to RZWQM.	Model coupling for soybean production modeling.	(Ma et al., 2005)
Loose coupling	SHAW	WOFOST	-/-	Custom framework with dynamic feedback	Irrigated maize study for water, carbon and energy balance.	(Li et al., 2013)

## List of coupled hydrologic and crop models' studies (continue)

Not indicated	SiB2	SiBcrop	-/-	Daily-base data exchange coupling.	ET and carbon exchange in wheat-maize croplands.	(Lei et al., 2010)
Integrated	SWAP	EPIC	-/-	Substitution of the WOFOST model in SWAP by EPIC	Ground water level effects on soil salinity and wheat yield.	(Xu et al., 2013)
Integrated	SWAP	WOFOST	SWAP	WOFOST integrated as a submodule in SWAP.	Presentation of the integrated SWAP model.	(Kroes et al., 2000)
Integrated	SWAT	EPIC	HEXM	Upgraded hydrologic module in SWAT with original EPIC module.	Integrated hydrologic system modelling	(Zhang et al., 2014)
Integrated	VIC	CropSyst	VIC– CropSyst	Tightly source code integration with modular approach.	Presentation of the VIC– CropSyst-v2	(Malek et al., 2017)
Framework	VIC	DSSAT	-/-	RHEAS framework	RHEAS framework presentation.	(Andreadis et al., 2017)
Loose coupling	WaSSI	DSSAT	GriDSSAT	GIS based I/O exchange coupling.	Hydrological impacts of irrigation.	(McNider et al., 2015a)
Framework	WRFV.3.3- CLM4	AgroIBIS	WRF3.3- CLM4crop	CESM1 framework	Crop growth and irrigation interact to influence surface fluxes	(Lu et al., 2015)
Loose coupling	WEP-L	WOFOST	-/-	One-ways data exchange with feedback.	Climate change impact on winter wheat.	(Jia, 2011)
Embedded	TOPLATS	WOFOST	WOFOST	WOFOST is coupled as subroutine to TOPLATS.	Coupled model optimization using LAI/soil moisture.	(Pauwels et al., 2007a)

## Models' References:

**WOFOST** (Diepen et al., 1989); **AgrolBIS** (Kucharik, 2003); **CESM1** (Kay et al., 2015); **CHAIN-2D** (Simunek and Van Genuchten, 1994); **CMF** (Kraft et al., 2011); **DRAINMOD** (Skaggs et al., 1996); **HYDRUS 1D** (Simunek et al., 2005); **InfoCrop** (Aggarwal et al., 2006); **JULES** (Best et al., 2011); **LSP** (Yuei-An and England, 1998); **OMS** (David et al., 2002); **OpenMI** (Gijsbers et al., 2002); **PILOTE** (Mailhol et al., 1997); **PMF** (Multsch et al., 2011); **PS123** (Driessen and Konijn, 1992); **RHEAS** (Andreadis et al., 2017); **RZWQM** (Ahuja et al., 2000); **SiB2** (Sellers et al., 1996); **SiBcrop** (Lokupitiya et al., 2009); **STICS** (Brisson et al., 1998); **SUCROS** (Goudriaan and Van Laar, 2012); **SWAP** (Kroes et al., 2000); **SWAT** (Santhi et al., 2001); **VIC** (Liang et al., 1994); **WaSSI** (Averyt et al., 2013); **WEP-L** (Jia et al., 2001);

## 4. Discussion conclusion

Meteorological observations, crop production, soil samples... etc., many data pertinent to watershed system are gathered at local scale. Current research support integrated assessments of complex systems based on place-oriented assessment. Building larger-scale understandings from localized case studies is an upscaling task (aggregation). Nonetheless, not all data are prompt to aggregation to estimate larger scale values, such as vector (i.e. wind) or intensive (i.e. temperature) data. However, technical solution for problems in upscaling exists, such as linking models between scales, changing model resolution or comparing aggregates with overall records (Fig. 11).

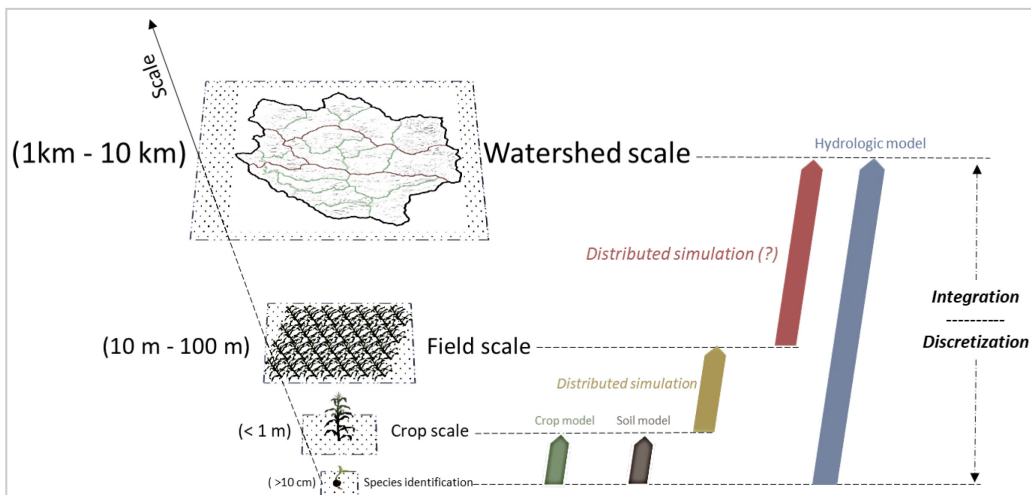

Fig. 11- Up/down simulation scaling

- integration /discretization of point-based/distributed simulation

Challenges related to data availability at detailed scales, the increasing complexity of causal relationships, and capturing contextual detail led to another essential aspect of coupling, downscaling. Because many driving forces (i.e. rainfall, topography...etc.) operate at watershed scale, they shape on-field realities. However, this is not easily attainable by interpolating spatially data, which results in great

uncertainties (Fig. 12 and Fig. 13, examples for rainfall and wind data). In addition, validation processes of the model's outputs that are not always attainable, due to lack of detailed observational datasets.

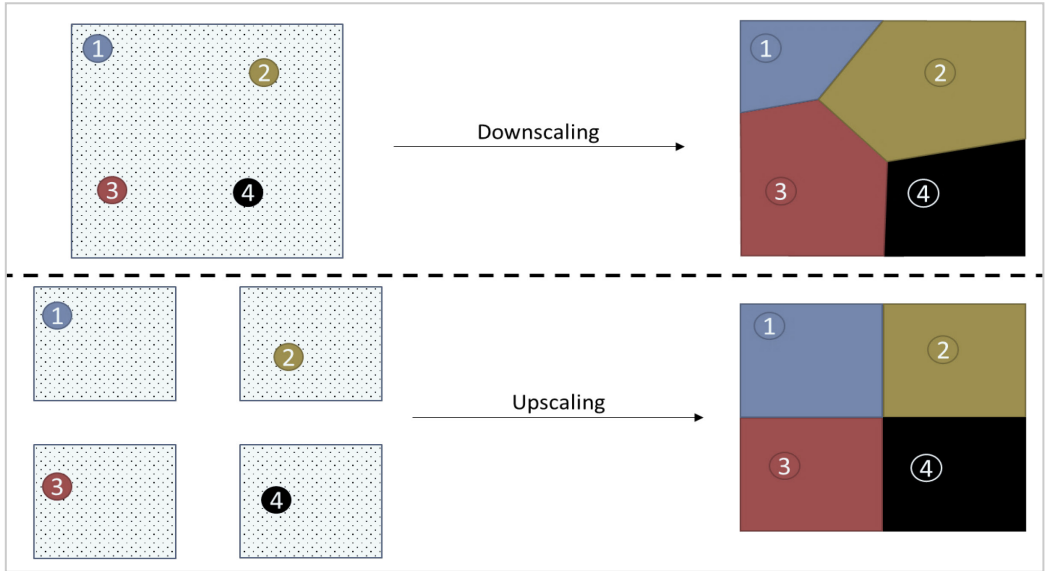

Fig. 12- Example of up/downscaling of rainfall data

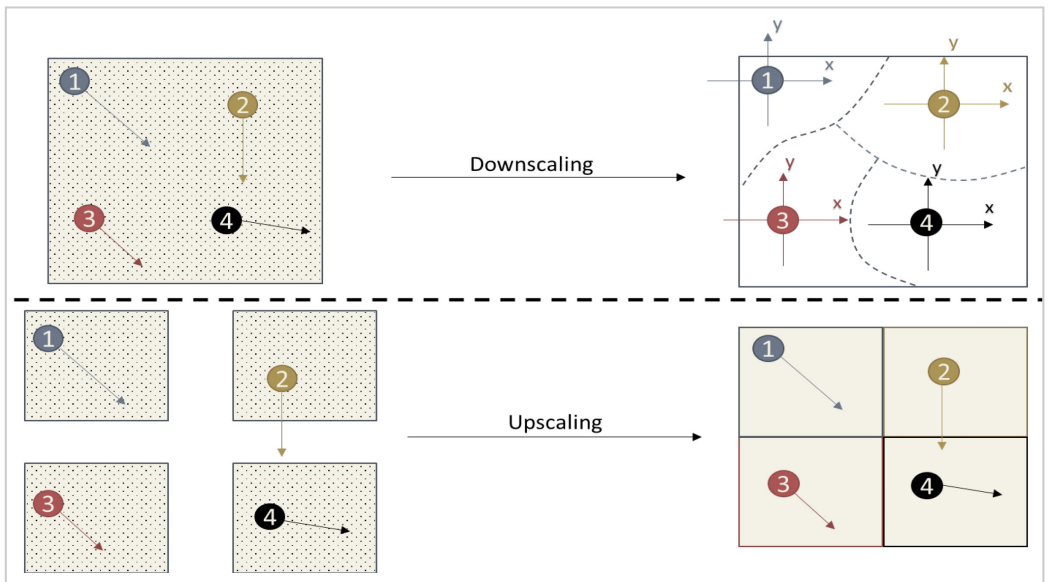

Fig. 13- Example of up/downscaling of wind data

Assuming that all relevant data are converted to a common metric, the coupling challenge has been greatly simplified. If the aim is to attain an integrated understanding of processes, simply converting numbers to a common spatial scale does not necessarily assure conceptual integration, as contrasted with computational integration where coupling method has a crucial role in system processes assimilation. It is often a matter of reconciling differences in process assumptions, theoretical foundations and perceived standards.

Last but not least, distributed hydrologic models are land-use dependent for soil function and rainfall distribution. Land use can significantly alter the seasonal and annual hydrological response within a catchment. Nevertheless, cropping systems represent one category among others (i.e. urban areas, forests, ...etc.). The prevalence of agricultural activity in a given hydrologic system will determine the potential benefit of incorporating crop model in hydrologic simulation.

---

*CHAPTER III:*

*IMPLEMENTING PARALLEL  
PROCESSING FOR DSSAT  
MODEL*

---

# CHAPTER III: IMPLEMENTING PARALLEL PROCESSING FOR DSSAT MODEL

## 1. Introduction

There are varying reasons to adopt parallelism, and it's important to understand the motivations and expectations for doing so (Craig et al., 2005, D'Amore et al., 2011, Dennis et al., 2012, Evans et al., 2012, David et al., 2013, Valcke, 2013, Dufaud and Tromeur-Dervout, 2013, Cohen-Boulakia et al., 2014, Formetta et al., 2016). Usually, scientific adopt parallelism for one or more of the following reasons:

- Application performance
- Applications where deriving the solution is time critical (i.e. weather prediction)
- Power savings by doing the same amount of work via efficiently threaded code
- Allow offering new capabilities for your application (e.g. add modules to an application with minimal impact to overall performance)

While the application domain has broadened, and modeling networks have expanded (Yao and Buzacott, 1986, Famiglietti and Wood, 1994, Probert et al., 1995, Adler, 1995, Sawik, 1995, Sellers et al., 1996, Wu and Crestani, 2003, Argent, 2004, Hill et al., 2004, Voinov et al., 2004, Malone et al., 2004, Bao et al., 2017, Qiu et al., 2017, Behr et al., 2017, Kotey, 2017, Rigolot et al., 2017, Will et al., 2017, Coleman et al., 2016, O'Keeffe et al., 2016), DSSAT (Jones et al., 2003) model implementations (along with other major models e.g. APSIM (Keating et al., 2003b)) have largely remained as it was a decade ago and FORTRAN is still used as the programming language (Fry et al., 2017, Attia et al., 2016, Vianna and Sentelhas, 2016, Corbeels et al., 2016, Ahmed et al., 2016, Dzotsi et al., 2010, Saseendran et al., 2010, Soler et al., 2007b, Ma et al., 2006, Jones et al., 2003). FORTRAN remains dominant primarily due to its legacy as the predominant language used by scientists and modelers from its inception in the 1950s through to the 80s and 90s when much of the science or

biological part of today's simulation models were initially developed (Jones et al., 2017, Sinclair and Seligman, 1996). DSSAT's models are typically large constructions each containing their own implementations of very common approaches to modelling crop and soil processes (White et al., 2011b, Weerts et al., 2010, Bao et al., 2017, Dokoohaki et al., 2016b, Jing et al., 2016, Li et al., 2015b).

This reliance comes from significant past efforts spent to build those model components, which to date are still performing and functioning well, and are heavily used by many scientists as critical parts of ongoing research delivery. Those legacy codes, however, are typically written using procedural languages, which challenges the options for evolving the code toward a more modern code base (Badr et al., 2016, Dokoohaki et al., 2016b).

To overcome this issue, this chapter introduces a method for implementing DSSAT-CSM for parallel processing on Windows -based Operating System (OS) without incorporating changes to the source code. It explains procedural technics of organizing and executing a set of runs in order to take advantage of CPU hardware resource and speedup simulations.

## 2. Summary of DSSAT-CSM run structure

The default DSSAT home directory provides the user a comprehensive an organized folders' structure and database. DSSAT Shell provides simple and effective tools for multiple simulation exercises. Nevertheless, applications that potentially involve many runs are best conducted through batch processing. It involves the use of MS-DOS command prompt to launch and control DSSAT-CSM execution.

Fig. 14, schemes the call and operations of DSSAT-CSM executable (DSCSM\*\*\*.EXE, where the '\*\*\*' indicate the version of the executable). The operation starts by defining and *Execution directory* where the command prompt (CMD) will be locked to. The command line that executes a given simulation has the following general form:

```
[DRIVE]:\[PATH:Directory]>[PATH:DSCSM***.EXE] B [optional: DSSAT-Model***] [PATH:DSSBatch.v**]
```

**Example:**

```
C:\myfolder>C:\DSSAT**\DSCSM***.EXE B CSCER*** C:\DSSAT47\Wheat\DSSBatch.v**
```

If the version of DSSAT used is 4.7, the \*\* and \*\*\* will be 47 and 047 respectively. In this case the command will be:

```
C:\myfolder>C:\DSSAT47\DSCSM047.EXE B CSCER047 C:\DSSAT47\Wheat\DSSBatch.v47
```

In this example, the location of DSCSM047.EXE is the default DSSAT directory, nevertheless it is not restricted to this location and it can be wherever it is accessible by the operating system.

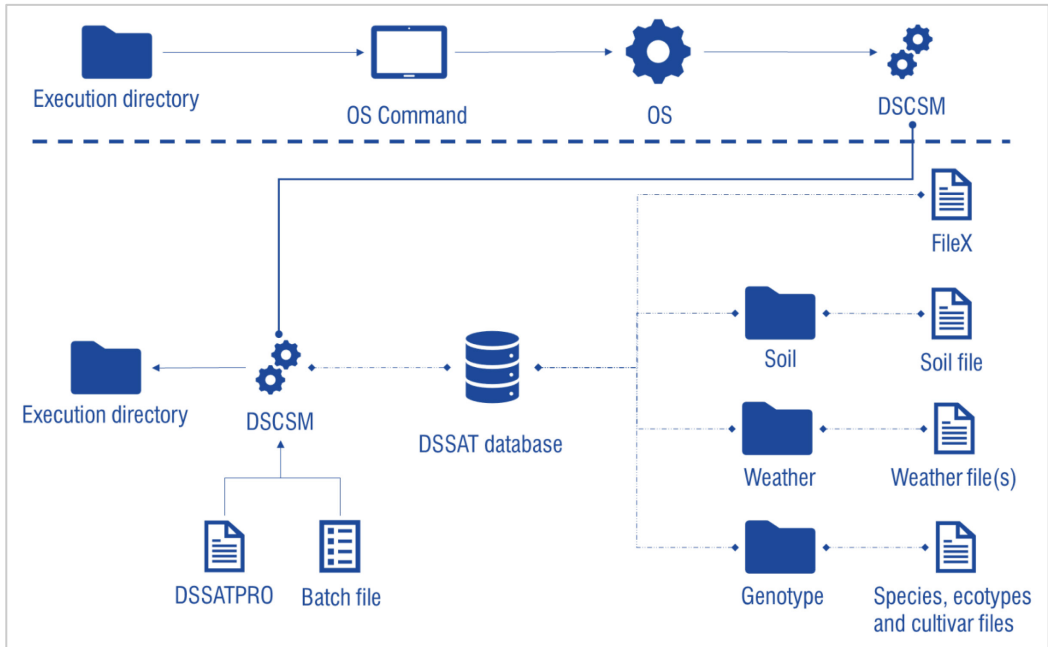

Fig. 14- Summary of DSSAT-CSM execution structure

The batch file contains a list of experimental files with their full path and treatment(s) that will be run for each of them. It is the reference list of runs of the DSCSM and it is executed sequentially (Fig. 15). The DSSATPRO file contains information about the locations of data directories and files required by the model (i.e. soil, weather, and genotype...etc.).

```

$BATCH(WHEAT)
!
! Directory   : C:\DSSAT47\Wheat
! Command Line : C:\DSSAT47\DSCSM047.EXE CSCER047 B DSSBatch.v47
! Crop       : Wheat
! Experiment  : KSAS8101.WHX
! ExpNo      : 1
! Debug      : C:\DSSAT47\DSCSM047.EXE CSCER047 " B DSSBatch.v47"
!
@FILEX
C:\DSSAT47\Wheat\KSAS8101.WHX
C:\DSSAT47\Wheat\KSAS8101.WHX
C:\DSSAT47\Wheat\KSAS8101.WHX
C:\DSSAT47\Wheat\KSAS8101.WHX

```

	TRTNO	RP	SQ	OP
C:\DSSAT47\Wheat\KSAS8101.WHX	6	1	0	0
C:\DSSAT47\Wheat\KSAS8101.WHX	3	1	0	0
C:\DSSAT47\Wheat\KSAS8101.WHX	1	1	0	0
C:\DSSAT47\Wheat\KSAS8101.WHX	2	1	0	0

Fig. 15- Example of DSSAT's batch file

### 3.Method description and testing

The method described here follows is based on the use of Windows batch file (BAT). Where the list of sequences of runs are executed in the DSSAT batch file are split at the initial CMD commands. This allows the OS to schedule the runs in multiple parallel threads and make an optimal use of CPU resources (Fig. 16). The requirements for this method are listed in Tab. 9.

The method consists on reducing the work assigned to the DSCSM executable to one unique run, as such, the threads will be scheduled by the OS and multiple independent runs can be spread across CPU's core.

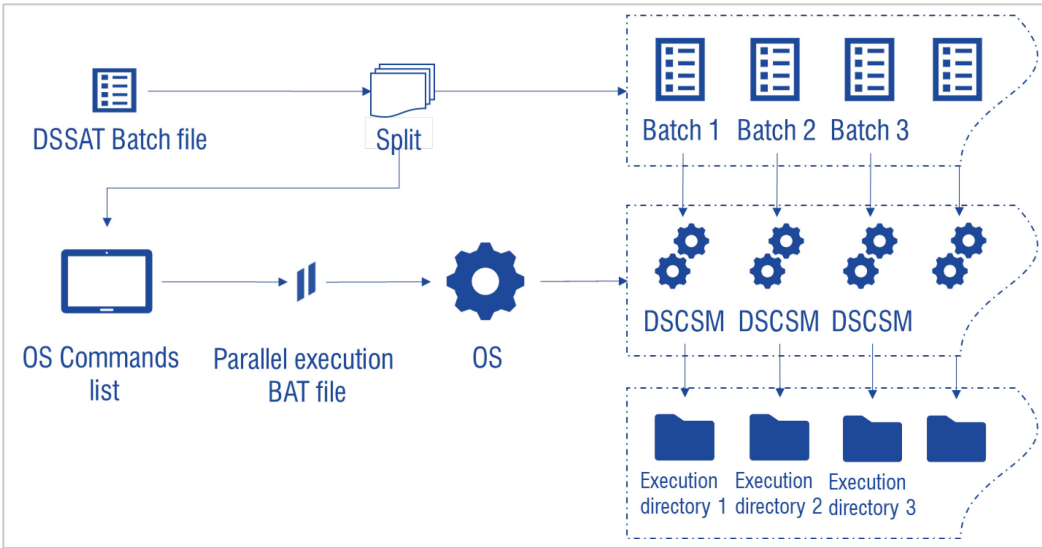

Fig. 16- DSSAT-CSM parallel execution structure

Tab. 9- Table of requirements

Resource	Comment
Windows OS	This method is described for this platform.
Multi-CPU hardware	To take advantage of parallel processing.
DSSAT	Installation of DSSAT should be present.
Lists of commands	That includes creation of folders and DSSAT batch file, and DSCSM runs
Parallel execution	Routine to execute multiple tasks simultaneously.
SSD (Optional)	Solid Stat Drive: Speed reading and writing operations

### 3.1.Parallel execution routine

The routine is written in Windows batch file and allow execution of a list of MS-DOS commands in parallel. The code is the following:

Tab. 10- Description of the BAT Parallelizer code

Order	Description	Code
1.	Display the output of each process if the /O option is used, if else ignore the output of each process.	<pre>@echo off setlocal enableDelayedExpansion if /i "%~1" equ "/O" ( set "lockHandle=1" set "showOutput=1"</pre>

		<pre>) else (   set "lockHandle=1 ^&gt;nul 9"   set "showOutput=" )</pre>
2.	List of commands goes here. Each command is prefixed with '...'	<pre>::: [command]</pre>
3.	Define the maximum number of parallel processes to run. Each process number can optionally be assigned to a particular server and/or CPU via PSEXEC specs (untested).	<pre>set "maxProc=[value]"</pre>
4.	Optional - Define CPU targets in terms of PSEXEC specs (everything but the command). If a CPU is not defined for a PROC delete this section, then it will be run on the local machine.	<pre>set cpu1=psexec \\server1 ... set cpu2=psexec \\server2 ... set cpu3=psexec \\server3 ...</pre>
5.	Set the number of CPUs	<pre>for /l %%N in (1 1 %maxProc%) do set "cpu%%N= [CPU number]"</pre>
6.	Get a unique base lock name. Incorporate a timestamp from wmic if possible, otherwise, incorporate a random number.	<pre>set "lock=" for /f "skip=1 delims=++ " %%T in ('2^&gt;nul wmic os get localdatetime') do ( set "lock=%%T" goto :break ) :break set "lock=%temp%\lock%lock%_%random%_"</pre>
7.	Initialize the counters	<pre>set /a "startCount=0, endCount=0"</pre>
8.	Clear any existing end flags	<pre>for /l %%N in (1 1 %maxProc%) do set "endProc%%N="</pre>
9.	Launch the commands in a loop	<pre>set launch=1 for /f "tokens=* delims=" %%A in ('findstr /b "&gt;:::" "%~f0"') do ( if !startCount! lss %maxProc% ( set /a "startCount+=1, nextProc=startCount" ) else ( call :wait ) )</pre>

		<pre> set cmd!nextProc!=%%A if defined showOutput echo -- echo !time! - proc!nextProc!: starting %%A 2&gt;nul del %lock%!nextProc! </pre>
10.	Redirect the lock handle to the lock file. The CMD process will maintain an exclusive lock on the lock file until the process ends.	<pre> start /b "" cmd /c %lockHandle%^&gt;"%lock%!nextProc!" 2^&gt;^&amp;1 !cpu%%N! %%A ) set "launch=" </pre>
11.	Wait for procs to finish in a loop. If still launching, then return as soon as a PROC ends. Otherwise, wait for all procs to finish, redirect stderr to null to suppress any error message if redirection within the loop fails.	<pre> :wait </pre>
12.	Redirect an unused file handle to the lock file. If the process is still running, then redirection will fail and the IF body will not run.	<pre> for /l %%N in (1 1 %startCount%) do ( if not defined endProc%%N if exist "%lock%%N" ( </pre>

13.	Made it inside the IF body so the process must have finished.	<pre> if defined showOutput echo = echo !time! - proc%%N: finished !cmd%%N! if defined showOutput type "%lock%%N" if defined launch ( set nextProc=%%N exit /b ) set /a "endCount+=1, endProc%%N=1" ) 9&gt;&gt;"%lock%%N" ) 2&gt;nul if %endCount% lss %startCount% ( 1&gt;nul 2&gt;nul ping /n 2 ::1 goto :wait ) 2&gt;nul del %lock%* if defined showOutput echo = </pre>
-----	---	---

Parts number 2 and 5 (optionally 4 when running on a server cluster) are the editable parts that have to be adapted for the simulation and hardware resources. This routine is used for: Create execution folders, Create DSSAT Batch files and runs by inserting the appropriate commands in section 2.

Here follow the general forms of the commands lists that has to be formulated for the section 2:

a) Folder commands form:

```
::: mkdir [PATH:Directory of execution]
```

b) DSSAT Batch commands form:

```
::: echo $BATCH([DSSAT-Model***]) >[PATH:DSSBatch.v**] & echo
[DSSBatch.v** variables header]>>[PATH:DSSBatch.v**] & echo
[PATH:FileX and control variables]>> [PATH:DSSBatch.v**]
```

c) Runs commands form:

```
::: cd [PATH:Directory of execution]> & [PATH:DSCSM***.EXE]
[optional: DSSAT-Model***] B [PATH:DSSBatch.v**] &exit
```

We recommend using distinct BAT file for every operation, then orchestrate their execution using an additional BAT file. Example:

If the BAT commands files routine are *FC.BAT*, *DB.BAT* and *RUN.BAT* for directories, DSSAT Batch files and Runs respectively. The control BAT file will be:

```
[PATH:FC.BAT] && [PATH:DB.BAT] && [PATH:RUN.BAT]
```

### 3.2. Benchmark

The method is tested using DSSAT's default database. DSSAT-Ceres model and (Campbell and Paul, 1978) experiments with its first treatment as a base run. A list of runs was generated (Tab. 11) and launched using the described method.

Tab. 11- Time benchmark assessment for different sets of runs

Run	Duration (seconds)				
	CC=1	CC=2	CC=4	CC=6	CC=8
1	0.8	0.7	0.7	0.8	0.7
50	191.5	83.4	36.3	22.3	15.8
100	383.1	166.7	72.6	44.6	31.6
500	1915.3	833.6	362.8	223.0	157.9
1000	3830.0	1667.1	725.6	446.1	315.9
2500	9575.4	4167.8	1814.1	1115.2	789.6
4000	15320.6	8868.4	3902.6	1784.3	1263.4
6000	22980.0	14502.6	6853.9	2676.5	1895.1

\* CC: Core-Count

To control the computer resources, we used virtual machine where the different configurations of Core-Count were set. The CPU frequency is 2.6 gigahertz and the amount of virtual memory allocated for all the sets is 8 gigabits. The OS and DSSAT were installed on a Solid-State Drive (SSD) with 550 megabits/s and 540 megabits/s

for read and write speed respectively. We used MATLAB Tic-Toc time routine to estimate time of execution of the setup batch (BAT) files.

Some aspects of the test are not controlled and have to be taken into account for the following analysis. Such as OS threads and priority schedule, multi-threading and CPU Turbo-Boost activation. Nevertheless, we limited the background tasks as much as possible and the only user executed task is the simulation.

The performance increased from 6 hours and half to about 30 minutes for 6000 runs on single and 8 cores respectively. Nonetheless, Fig. 17 shows a non-linear relation between the number of runs and the time required for execution for every set of CC.

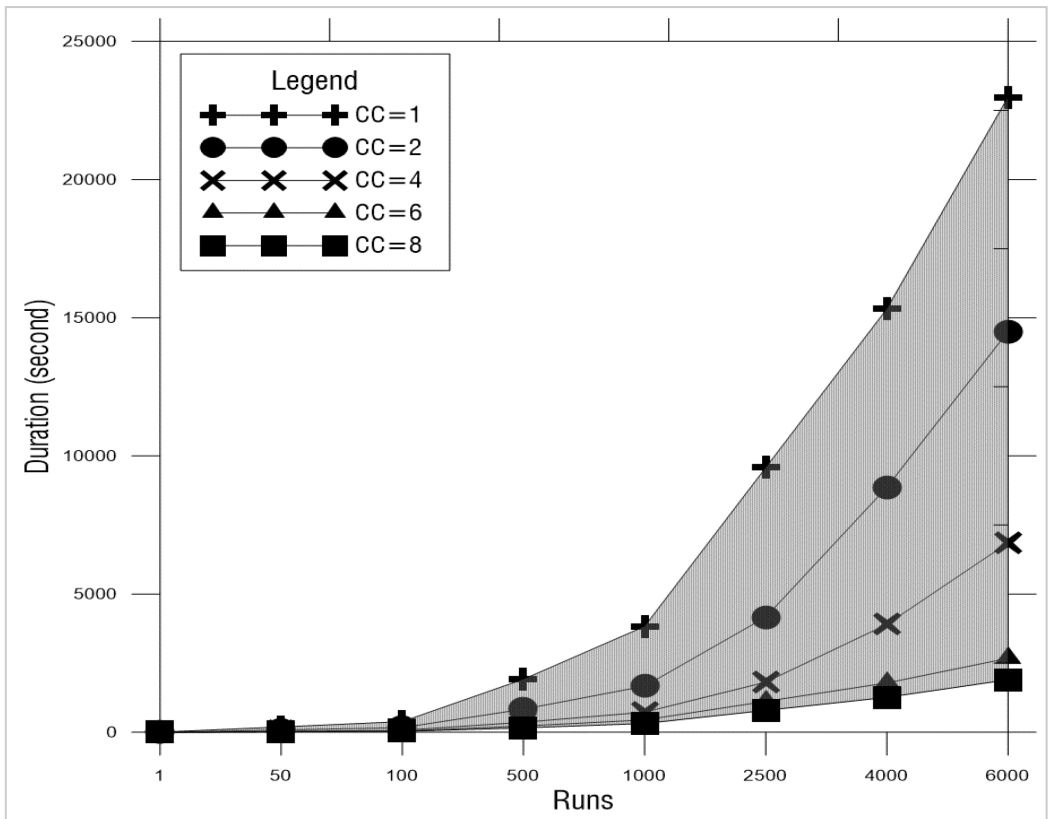

Fig. 17- Time benchmark of setoff runs with different core-count configuration

Fig. 18 shows the proportional gain in time relatively to the increase in CC. The results suggest that for relatively low number of runs, the performance is not noticeable. Nevertheless, as much as the number of runs increases, time gain become more noticeable.

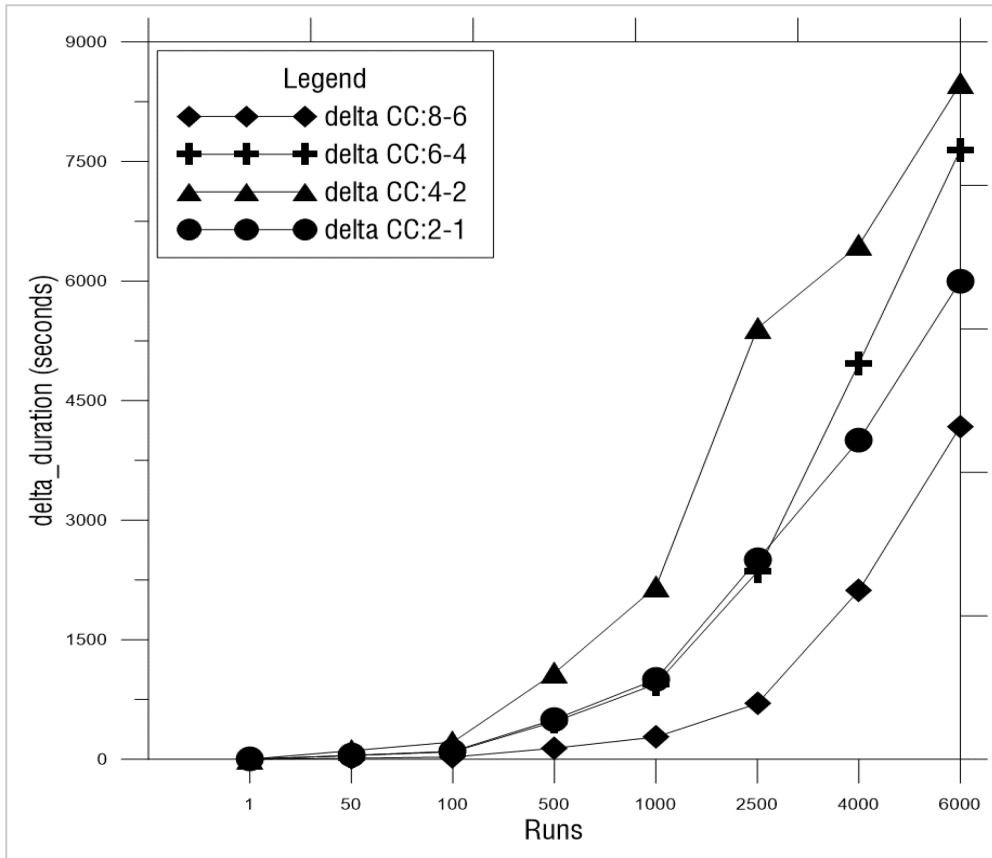

Fig. 18- Difference increase of time and core-count

\*delta\_duration: difference increase in execution time

\*delta CC: difference increase in CC

#### 4. Discussion and conclusion

In this chapter we presented a method for implementing parallel processing in DSSAT model. The benchmark results demonstrate that it is suitable for heavy simulations where many independent DSSAT runs has to be launched. With some

precedent requirements, the method is mainly based on the implantation of the parallelization routine and doesn't require incorporating any change to the DSSAT's DSCSM source code.

In case of spatial implantation of DSSAT, it remains point-based. The parallelization routine runs multiple points in parallel as the DSCSM instances themselves remain intrinsically independent, in that they respond to a combination of soil and weather, they are being wrapped and executed in parallel to simulate broader scales. A key challenge is in how the individual point models are parameterized in these gridded applications, and whether these points interact with each other. Climate, soil and management information are required at each grid cell, but accurate, detailed data are almost never available.

---

*CHAPTER IV:*

*VICA - GENETIC CALIBRATION  
TOOL FOR DSSAT MODEL*

---

## CHAPTER IV: VICA - GENETIC CALIBRATION TOOL FOR DSSAT MODEL

### 1. Introduction

Crop growth models provide knowledge and tools of important utility in sustainable land and water resources management for crop system performance improvement (Kroes et al., 2000, Adam et al., 2013, Argent et al., 2009, Attia et al., 2016, Manfreda et al., 2010). Models are increasingly used in order to simulate scenarios for food insecurity and required adaptation to climate change in order to provide management insights and help mitigate external forces on crop systems (Guan et al., 2017, Bao et al., 2017, Joshi et al., 2017, Vanuytrecht and Thorburn, 2017). Nevertheless, many issues are challenging scientists in this regard. For instance, the endemic lack of reliable data for calibration-testing of models, the optimization of model parameterization, the identification of breakthrough technologies that are expected to improve crop modelling (Magombeyi and Taigbenu, 2011, Papajorgji et al., 2004, Dokoohaki et al., 2016a, Hoogenboom, 1999, White et al., 2011b).

The Decision Support System for Agrotechnology Transfer (DSSAT) (Jones et al., 2002) is a widely used simulation tool for cropping systems that was designed to combine accurate predictions of economic products (e.g., grain, biomass, or sugar yield) for many species in response to climate and management conditions (Gijssman et al., 2002, Jones et al., 2003, Suleiman and Ritchie, 2004, Saseendran et al., 2007, Dzotsi et al., 2010, Liu et al., 2011, Lizaso et al., 2011). As in its actual version 4.7, it comprises dynamic crop growth simulation models for over 40 crops. DSSAT is supported by a range of utilities and apps for weather, soil, genetic, crop management, and observational experimental data, and includes example data sets for the included crop models (Ahmed and Hassan, 2011, Alexandrov, 1997, Anothai et al., 2013, Araya et al., 2017, Asadi and Clemente, 2003, Beinroth et al., 1997, Yang and Huffman, 2004, Yellin, 2001, Vazquez et al., 2009).

In an agricultural system, crop productivity varies with varying climatic and edaphic conditions (Lal et al., 1993, Probert et al., 1995, Carberry et al., 2002, Asseng

et al., 2002, Ittersum et al., 2003). Models have been developed to best understand yield gaps and optimization of yield potential (Singh and Virmani, 1996, Gerke et al., 1999, Hartkamp et al., 2002, Huth et al., 2002, Bannayan et al., 2003, Yu et al., 2006, Gijssman et al., 2007, Saseendran et al., 2009, Persson et al., 2010, White et al., 2011a). Crop model parameters are usually determined by iterative parameter adjustment and comparison with observed data from field trials (Singh and Virmani, 1996, Robertson et al., 2002, Soler et al., 2007b, Anothai et al., 2008, Chen et al., 2008, Bannayan and Hoogenboom, 2009). A time-consuming task that depends highly on the expertise of the scientist, familiarity with the model, the field investigated and the crop-cultivar. DSSAT incorporate two tools to help the user in this regard:

- Generalized Likelihood Uncertainty Estimation (GLUE): a statistical R tool based on the assumption that the parameters belong to a normal distribution.
- Genotype coefficient calculator (GenCalc): a rule-based tool for estimation of genetic coefficient (Anothai et al., 2008, Bao et al., 2017).

Nevertheless, the proposed tools miss in encompassing the nonlinearity of DSSAT model and are either time consuming, this is the case of GLUE, or propose sequential approach by calibration in series the genetic coefficients (GenCalc).

The present work presents VICA, a new genetic coefficient calibrator tool for the DSSAT software. VICA is based on observations of DSSAT's models' responses to genetic coefficients variation. It aims of proposing an analytical approach for genetic parameters estimation and optimal use of computer hardware resources. VICA will be applied in *CHAPTER VI* of the present thesis.

## 2.VICA: Visual-based Insights Calibration Analogue

### 2.1.VICA user interface

VICA Graphical User Interface (GUI) (Fig. 19) is presented as one window divided in numbered sections. The numbers serve as guide for the user in setting the simulation configuration.

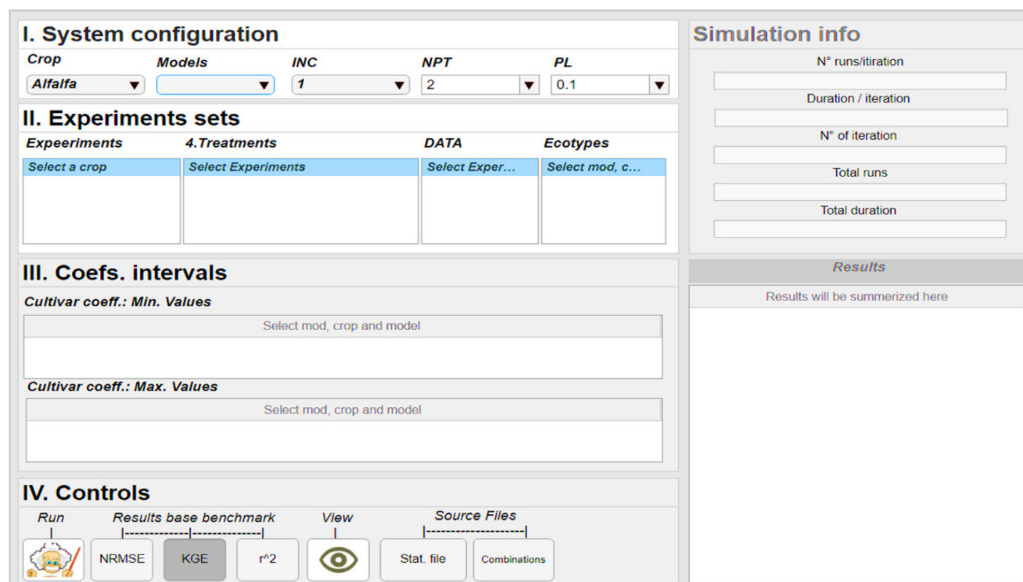

Fig. 19- VICA GUI

In section *I. System configuration*, user starts by selecting a crop in the drop-down list and a list of models associated will be proposed. All the remaining section after that is configured automatically. The user can adjust the parameters: INC, NPT and PL; described in the following (Tab. 12); to adapt to system hardware resource.

In section *II. Experiments sets* a mix of experiments and treatments related to a cultivar to be calibrate can be selected and their shared experimental data. *III. Coefs. Intervals*, the tables are filled using default values present in cultivar file of DSSAT database. The user can have an estimation of the simulation performance through the *Simulation info* section.

The *IV. Control section* the user can define the base benchmark parameters among the three available (NRMSE, KGE and  $r^2$ ). After completion of the calibration,

results will be displayed in the *Results* section. The best run candidates are listed based on the parameters NRMSE, KGE and  $r^2$ , experiments and treatments. An advanced plotter module is available through the *View* button.

Tab. 12- VICA GUI sections description

Section	Components	Description
I. System configuration	Crop	Crops list.
	Models	Models associated with the crop selected.
	INC	Initial Number of Classes is the number of sub interval on which be divided the parameters interval length.
	NPT*	Number of Parallel Threads is the number simultaneous runs that will be launched.
	PL*	Precision Level is the maximum interval length and it is expressed in percentage of initial interval length.
II. Experiments sets	Experiments	Experiments available in the DSSAT crop directory.
	Treatments	Treatments of the experiment.
	DATA	Data records of the experiments.
	Ecotype	Ecotype associated with the cultivar currently calibrated.
III. Coef. intervals	Cultivar coef.: Min. Values*	Set of minimums of parameters' values from the database associated with the cultivar file.
	Cultivar coef.: Max. Values*	Set of maximums of parameters' values from the database associated with the cultivar file.
VI. Controls	Run	Launch simulations.
	Results base benchmark	Parameters that will be used for experimental data and simulation comparison.
	View	Simulation plot.
	Source Files	View of combination and statistics sources files.
Simulation info.	N° of runs/iteration	Number of runs per iteration.
	Duration/iteration	Duration per iteration.
	N° of iterations	Number of iterations.
	Total runs	Total runs of the calibration.
	Total duration	Duration of the calibration.
Results	Results summary	Table of results of the best run displayed based on the benchmark parameters selected along with statistics of fit.

\*: manual entries can be set

## 2.2.Directory structure

VICA is a DSSAT dependent tool. It has to be installed on machines where DSSAT database is already installed (Fig. 20). Nevertheless, it is completely independent from its shell and execution. VICA route directory has three types of file:

- Route execution directory: runs are carried in a series of subfolder classed as indicated in Fig. 20
- Combinations.CCF: Coefficients combination file where the cultivar coefficients are generated
- VICA: Stand-alone executable

It worth mention that only the VICA executable is necessary for execution. Other folders and files are generated during simulation.

The files resident in the DSSAT's execution directories are the same as the one present in the crop folders within DSSAT home directory. Nevertheless, all the outputs for all the simulations and iterations are kept and no file is overwritten.

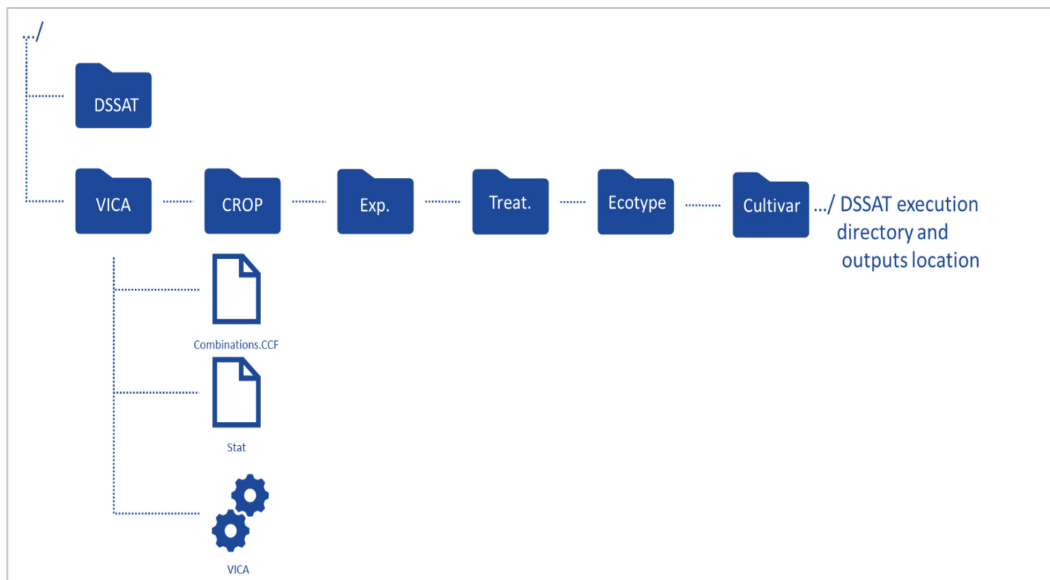

Fig. 20- VICA directories structure

## 2.3. Execution structure

VICA routines are organized as described in Tab. 13 and Fig. 21.

Tab. 13- VICA routines description and organization

Order	Routine	Description
1	Data reader	Reads experiments, treatments, ecotype and cultivar formatted data.
2	Simulation configuration	Compute the number of runs and iterations and estimate time requirement for execution. In addition, it determines system resources allocation.
2	File editor/copier	Defines the experiments, ecotype and cultivar files needed.
3	Tasks configurator	Defines the execution and organize operations (file copying and editing) runs and iterations in sequences.
4	Tasks lister	Organize sequences of operation and order.
5	Task Parallelizer	Schedule execution of lists of operations that will be provided to the Operating system
6	Task scheduler	Launches and orchestrates the execution of the lists of operations: Creation of directories, copy files, runs and benchmark.
7	Data reader	Read one iteration data and perform benchmark of the runs.
-	Data plotter	Used at the end of calibration to visualize data.

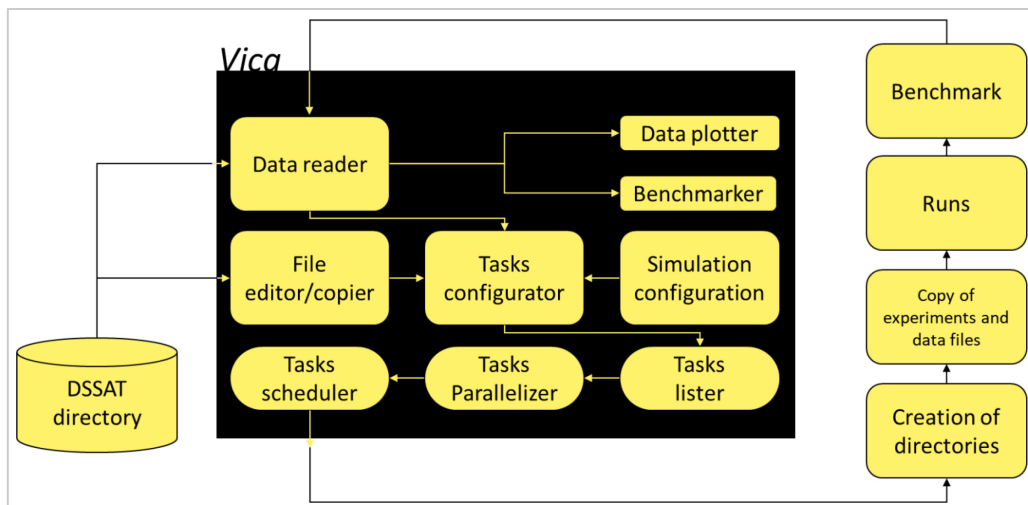

Fig. 21- VICA execution structure

### 3.Theory and concepts

#### 3.1.Background

DSSAT is a non-linear model and the error  $e$  between simulated and recorded variables is a function, denoted  $F$ , of the cultivar coefficients.

$$\text{Eq. 1: } \forall n \in N^*, e = F(x_1, x_2, x_3, \dots, x_n)$$

Where:  $x_1, x_2, x_3, \dots, x_n$  are the cultivar coefficients, and  $n$  the number of coefficients.

When reduced to one coefficient,  $x_i$ , the optimization process of the function  $F$  follows typically a second order polynomial curve (Fig. 22).

$$\text{Eq. 2: } \forall i \in N^*, e = f(x_i) = a * x_i^2 + b * x_i + c$$

Where:  $i$  is the variable index and  $a, b$  and  $c$  are the polynomial parameters of a smoothed fitting second order function, and  $f$  the reduced function of  $F$ .

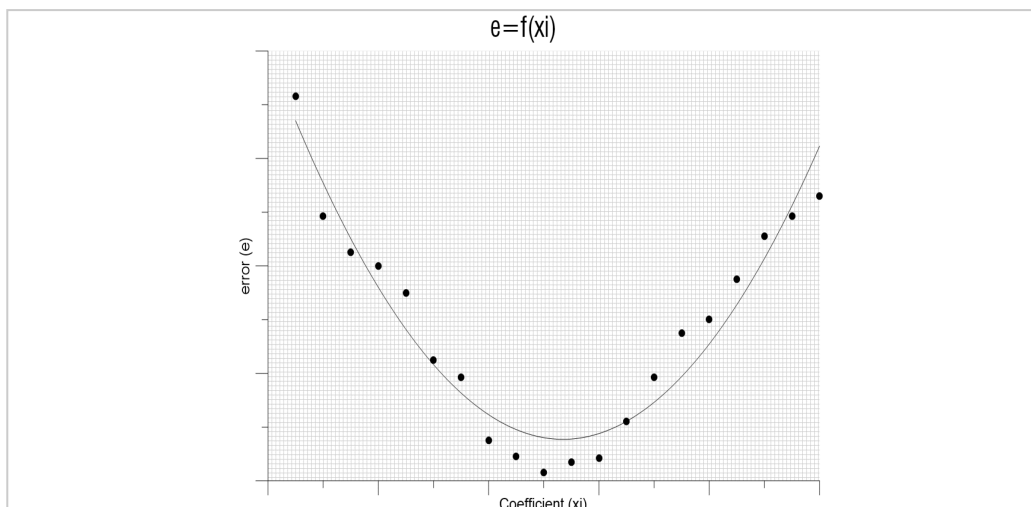

Fig. 22- Example of error records  $e$  in function of cultivar coefficient  $x_i$ .

\*The trails are done using wheat, MANITOU cultivar, DSSAT-Ceres model and (Campbell and Paul, 1978) experiments. The variable analyzed is leaf area index with the coefficient PHINT.

The solution,  $X$ , to the equation Eq. 2 corresponds to the value of  $x_i$  that minimizes the function  $f$  on the interval  $I$ .

$$\text{Eq. 3: } \forall i \in N^*, \forall (X, x_i) \in I_i, f(X) \leq f(x_i)$$

$$\text{Eq. 4: } \Rightarrow f'(x_i) = 0$$

Where  $f'$  is the derivative of first order of the function  $f$ .

Considering the parameters  $x_1, x_2, x_3, \dots, x_n$ , the function  $F$  can be expressed:

$$\text{Eq. 5: } \forall n \in N^*, \forall \{(X_1, x_1), \dots, (X_n, x_n)\} \in \{I_1^2, \dots, I_n^2\}, F(X_1, \dots, X_n) \leq F(x_1, \dots, x_n)$$

$$\text{Eq. 6: } \Rightarrow F'(x_1, \dots, x_n) = 0$$

Where:  $(X_1, x_1), \dots, (X_n, x_n)$  are the couples (solution, variable) and  $I_1, \dots, I_n$  are the corresponding interval of variation.

### 3.2. Cultivar coefficients solver

Eq. 6 is a multidimensional system for which the solution is the set of cultivar coefficients corresponding to the minimum of the function  $F$ . The solution proposed is a graphical-based approach that uses the properties of the function  $f$  in combination with combinatory iteration.

For each stat of the system  $F$ , a function  $f$  can be defined for one of the cultivar's variable  $x_i$ . In combination, each value of the variable  $x_i$  correspond to distinctive functions of the other variables (Example in Fig. 23)

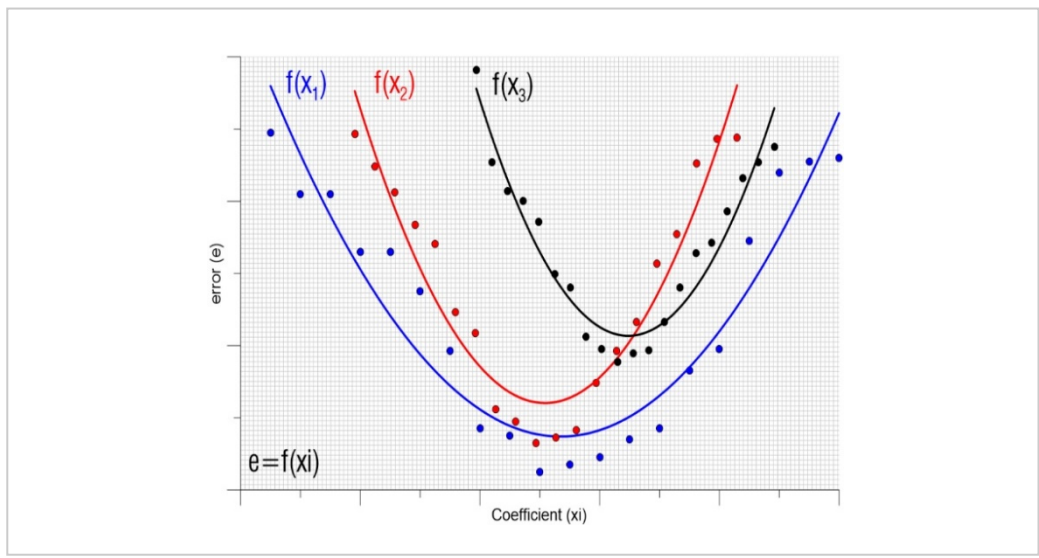

Fig. 23- Example of error records  $e$  in function of two cultivar coefficients  $x_i$ . Trails sets are the same as in Fig. 23, except the addition of P1V, for which three values are given corresponding to the three curves.

To determine the minimum of all sets of stats, the interval variation of each cultivar coefficient, denoted  $I_1, \dots, I_n$ , is divided in sub-interval; the designation of *Classes* will be adopted from now on to refer to sub-intervals; Such as:

$$Eq. 7: \forall i, m \in N^*, I_i = C_k^i 1 \cup C_k^i 2 \cup C_k^i 3 \cup \dots \cup C_k^i m$$

Where:  $I_i$  is the interval corresponding to the variable  $x_i$ , and  $C_k^i 1, C_k^i 2, C_k^i 3, \dots, C_k^i m$  are the classes of the interval  $I_i$  and the  $k$ th iteration.

A minimum of three classes per interval are required (\*\*). Then a combination of sets of all the variables are generated (Tab. 14) and analyzed to determine the set that correspond to the lowest value of the function  $F$  using three benchmark parameters to perform the selection of best set configuration( Kling-Gupta Efficiency (KGE) (Gupta et al., 2009), correlation coefficient ( $r^2$ ) and the Normalized Root-Mean Square Error (NRMSE)).

\*\* : three points are required to construct a second order polynomial.

$$\text{Eq. 8: } KGE = 1 - \sqrt{((r - 1)^2 + (\alpha - 1)^2 + (\beta - 1)^2)}$$

$$\text{Eq. 9: } r = \frac{\text{cov}(\text{sim}, \text{obs})}{\sigma_{\text{sim}} * \sigma_{\text{obs}}}$$

$$\text{Eq. 10: } \beta = \mu \left( \frac{\text{sim}}{\text{obs}} \right)$$

$$\text{Eq. 11: } \alpha = \frac{\sigma_{\text{sim}}}{\sigma_{\text{obs}}}$$

Tab. 14- Variables and classes matrix

$x_1$	...	$x_n$
$c_1^1$	...	$c_1^n$
...	$c_l^j$	...
$c_1^m$	...	$c_1^n$

\*  $c_k^i$  is the central value of the class  $C_k^i$  And  $j$  the class index.

The number of combinations,  $Q$ , for one iteration is:

$$\text{Eq. 12: } Q = m^n$$

Where:  $m$  is the number of classes and  $n$  the number of coefficients.

The above procedure corresponds to one iteration, then after, each class candidate selected of every variable is divided into classes and the process is repeated till the interval length of the class  $C_k^i$  is inferior to a threshold of its initial length (Eq. 14) (corresponding to the PL in the VICA initial setup configuration).

$$\text{Eq. 13: } \forall i, j, k, m \in N^*, C_k^i = c_k^i 1 \cup \dots \cup c_k^i m$$

$$\text{Eq. 14: Condition : } c_k^i \leq PL * I_i$$

The algorithm is valid with the assumption that the solution is part of the initial interval:

$$\text{Eq. 15: } \forall i, j, k \in N^*, E c_{kj}^i \in I_i, f(c_{k+1j}^i) \geq f(c_{kj}^i)$$

Where:  $c_{k+1j}^i$  and  $c_{kj}^i$  are the class candidate at iteration  $k$  and  $k + 1$ .

#### 4. Discussion and conclusion

The design of the VICA was undertaken to help overcome the complexity of cultivar calibration and to facilitate this process for broader user who are not advanced in using DSSAT. Although the VICA is new and doesn't not support all the crops available in DSSAT (i.e. rice) in its actual version, it offers an insight on DSSAT's models' behavior and adapt its use for modern computer architecture.

A more difficult issue is, however, the gap between software development and applied research contributors. As in the case of VICA development, the implementation of parallel processing can be implemented with DSSAT its self, but this will require it restructuration at a code level. This cause a major issue as DSSAT development relies on its community contributors in code development and modules extension.

---

*CHAPTER V:*

*DETERMINATION OF PLANTING  
DATE USING MODIS LEAF AREA  
INDEX*

---

# CHAPTER V: DETERMINATION OF PLANTING DATE USING MODIS LEAF AREA INDEX

## 1. Introduction

Planting date is an important management information, which is typically required by crop models. time of sowing has a considerable effect on yield due to the variability of weather (timing and amount of wet and dry periods, temperature variability) that strongly interacts with crop phenological phases (International Research Institute for et al., 2018, Li et al., 2015b, Dzotsi et al., 2010, Gijsman et al., 2007, Hoogenboom et al., 1992). climate change has already been found to modify plant phenology mainly due to the extension of the growing season in many areas. shifts in precipitation patterns (e.g. the expected decrease in summer precipitation together with earlier growing season start) require reconsideration of existing planting dates in order to avoid drought induced yield loss (Bao et al., 2017, Vanuytrecht and Thorburn, 2017, Okoro et al., 2017, Araya et al., 2015). In order to create adaptive agroecological simulations, realistic estimations of human management practices are needed, including planting practice and its potential changes in the future.

Three planting date estimation methods are used in crop modelling for different purposes. The first one uses predefined and constant planting dates based on observations, typically representing average planting time for some period (De Noblet-Ducoudré et al., 2004, Drewniak et al., 2013, Waha et al., 2012, Deryng et al., 2011). The second, to optimizes planting date in order to maximize the yield (Stehfest et al., 2007, Waongo et al., 2015). The third approach uses climate data to estimate the optimal conditions for a given crop for planting (Arthur et al., 2017, Jones et al., 2017, Jones et al., 2003) and can be particularly useful in climate change impact studies.

In addition to the mentioned option, the majority of state-of-the art crop models allow to define planting dates using predefined rules (Moore et al., 2014). For instance, the CropSyst model determines the planting date using air temperature and the actual soil water content (Stöckle et al., 2003). The STICS (Brisson et al., 1998) model uses

soil moisture and precipitation thresholds to determine the planting date. In DSSAT model (Jones et al., 2003), soil water content, management depth for water and soil temperature thresholds need to be set to estimate planting date within an interval sowing window (Jones et al., 2003, White et al., 2011a). the APSIM model provides more flexibility by allowing the user to defined sowing rules based on any internally calculated model variable (Keating et al., 2003b, Holzworth et al., 2014).

Planting date is a fundamentally an input data in non-forecasting simulation. A realistic reproduction of given cropping system development requires the actual planting date. The attempt to encompass farmers' decisions that affect the planting date in a mathematical representation is challenging task because of a large portion of subjective factors included in such decisions. Nevertheless, technological advancement offers great opportunities to address this issue. Indeed, remote sensing science and the art of acquiring information about an object by observing it from a distance is great alternative for estimating planting date. Indeed, sensors can acquire data remotely while being on board different platforms (i.e: satellites, aeroplanes, etc.)(Li et al., 2017, Kharbouche et al., 2017, Martinez-Lopez et al., 2016, Locherer et al., 2015, Butler et al., 2014).

Remote sensing data are mostly based on light interception (especially LAI or Fraction of Photosynthetically Active Radiation fAPAR) and can provide information on different growth status of the crop(Li et al., 2017, Li et al., 2015a, Jia, 2011, De Noblet-Ducoudré et al., 2004). To date, most of the studies examine the assimilation of LAI as a variable for crop yield estimation but there are other factors affecting crop development, such as water stress, nutrient supply and pests that cannot be integrated in actual modelling framework without changing their mechanistic modeling approach. In this chapter, we propose an alternative use and assimilation of LAI data into crop models. We present a method for determination of planting date using remotely sensed LAI. The method is applied in *Chapter VI* of this thesis as a validation.

## 2. Material and methods

## 2.1.Base principle

The method aims to investigate LAI data series for crop growth emergence phase. It uses remote sensed datums at a temporal scale to determine the temporal interval that contains the actual planting date. The interval is determined in three steps as follow:

1. Split LAI data series into local minimums and maximums
2. Locate flat zones just afterward the local minimums
3. Locate the last local non-inflecting minimum inside the flat zone.
4. Step backward for the previous datum to set the interval.

The length of the interval is function of the initial data temporal resolution. Post-process for this method can help to determine the exact date.

## 2.2.Illustration sets

The following illustration uses the level-4 MODIS global LAI and fPAR product (MOD15A2) at 8 days and 1-km resolution on a Sinusoidal grid (Disney et al., 2016). The data are for 2000-2013-time frame.

The data sample are for the Celone watershed, southern Italy. An agricultural dominated watershed dedicated to grow durum wheat. The MODIS' LAI data are averaged spatially over the area. An example application is shown using the DSSAT-Ceres wheat model over one growing season.

## 2.3.Description

In the present description, MATLAB is used, nevertheless, it is not limited to and other tools might be used for time series data analysis.

The smoothing (or fitting) using a piecewise sum of parabolic functions (a sum of parabolic functions by interval determined by the peaks in data points series) (Fig. 24) allows to split data series and estimate local minimums and maximums (Fig. 25).

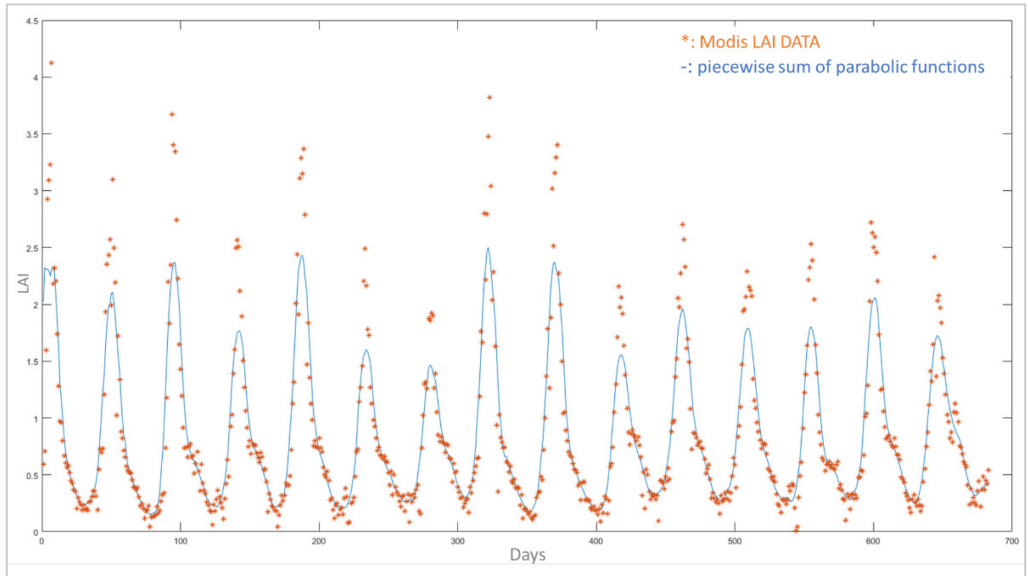

Fig. 24- MODIS' LAI data fitting using some of parabolic functions

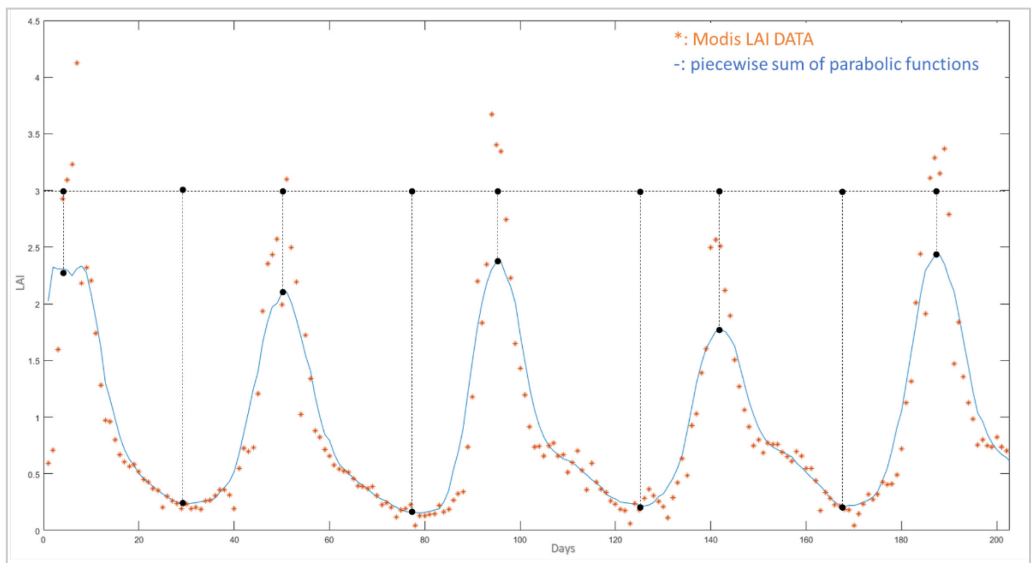

Fig. 25- MODIS' LAI data series deviation according to local minimums and maximums

Despite noises in MODIS' LAI data due to the spatial averaging, a flat zone is observable on the fitting curve (Fig. 26) that will allow then after to gather the set of MODIS' LAI datums that shows an emergence of crop growth phase (Fig. 27).

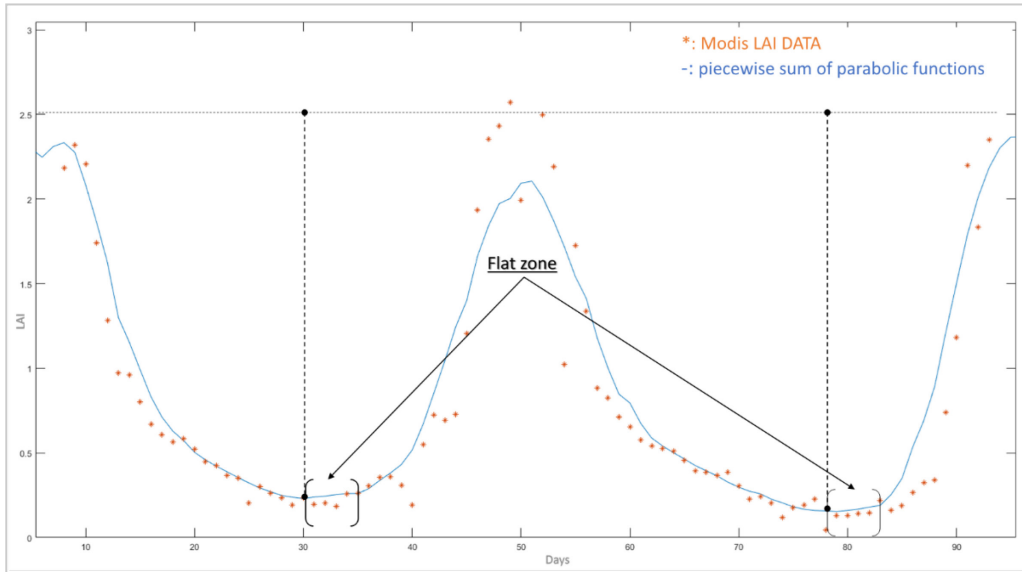

Fig. 26- Example of flat zones locations

The last lowest point in MODIS' LAI data correspond the start continuous increase in the fitting curve. Along with the precedent datum (Fig. 27), the set interval has a length of 8 days (MODIS' LAI temporal resolution).

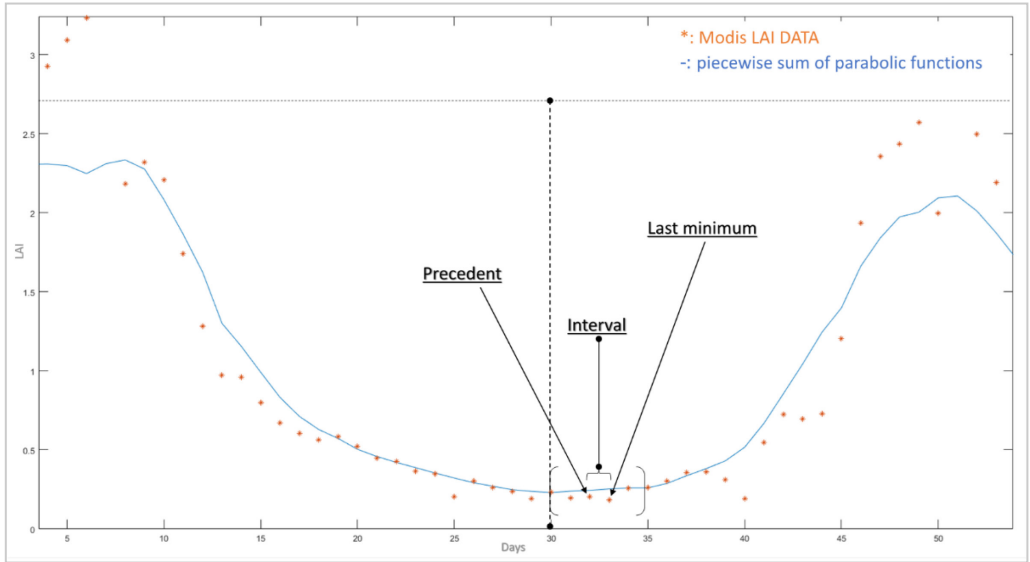

Fig. 27- Planting date interval

Fig. 28 shows a simulation example of DSSAT-Ceres wheat model. The extracted datum is set as input for the model. As post process, we considered MODIS LAI and DSSAT-Ceres LAI peaks matching (Fig. 28). This allowed to reduce the initial 8 days interval to one day, which is the planting day considered.

Fig. 29 shows growth emergence of the DSSAT-Ceres wheat model that correspond to MODIS LAI trend variation.

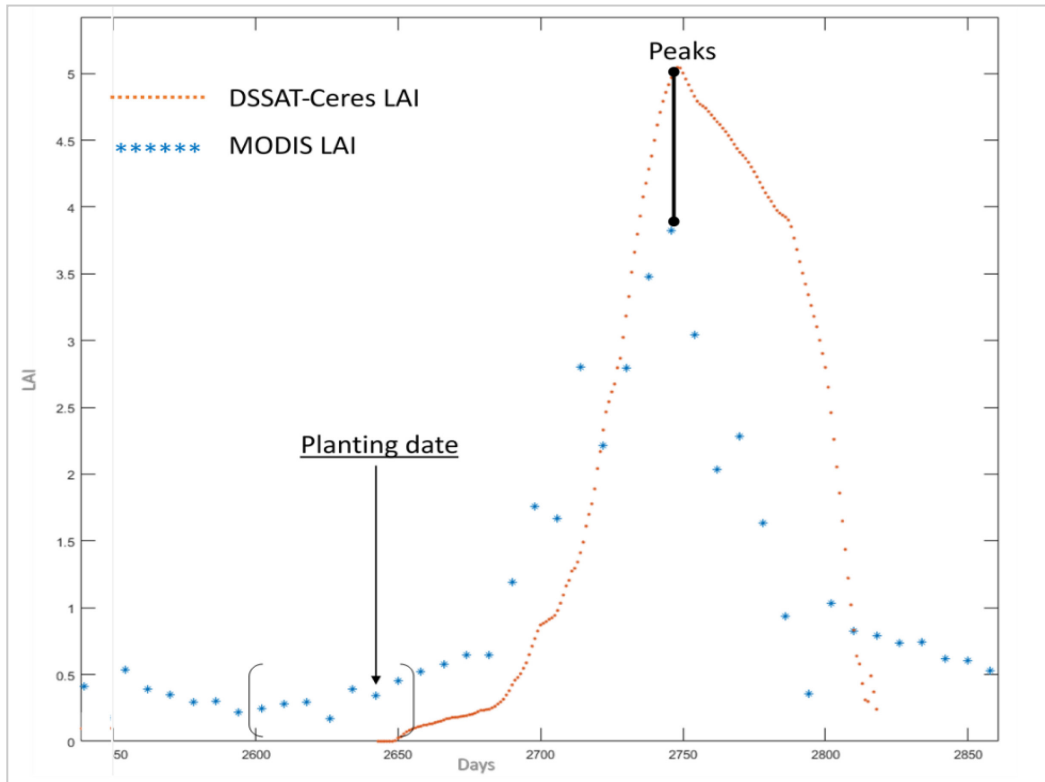

Fig. 28- Last minimum in the planting date interval: Application to the DSSAT-Ceres model

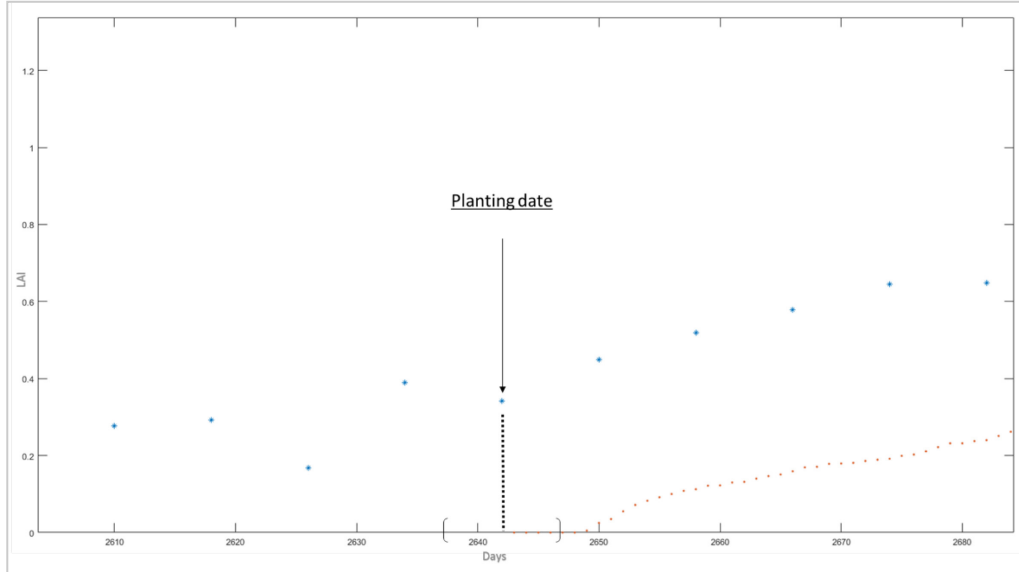

Fig. 29- DSSAT-Ceres LAI at emergence

### 3. Conclusion and recommendations

We presented in this chapter a relatively simple method to estimate planting date using remotely sensed LAI. It aims to propose an alternative to traditional fixed and/or based on climatic factors to estimate plating date. Nevertheless, it worth to record that the case application of this work is predominated by wheat cultivation area where the sensed LAI trends is mainly assigned to wheat growth.

Another important aspect to consider is the scale of data averaging. Indeed, a low spatial resolution of the LAI sensed induces a significant noise in data series and it might lead to difficulties in the visual assessment of the flat zones described in Fig. 3.

The temporal resolution plays an important role in the post processing and the estimation of the exact day of plating. Indeed, the emergence phase of seasonal crops is relatively short. In order to be observable, it is recommended to have LAI datum of less than 2 weeks temporal resolution.

A secondary data source is required for trails to shorten the interval and fix the planting date. Peaks in simulated and observed LAI matching is one option, nevertheless, other corresponding data, such as yield, can be used for the final set of planting date.

---

*CHAPTER V:*

*DREAM-DSSAT COUPLED  
HYDRO-CROP MODEL FOR  
INTEGRATED AGRO-  
HYDROLOGIC SYSTEM STUDY*

---

## CHAPTER VI: DREAM-DSSAT COUPLED HYDRO-CROP MODEL FOR INTEGRATED AGRO-HYDROLOGIC SYSTEM STUDY

### 1. Introduction

Population growth, rise of living standard, increase of life expectancy, economic competition and globalization are some of the leading factors that accelerate human pressure on the environment (Shirokanov, 2014). Irremediably, landscapes are being remodeled through urbanization and intensification of agricultural activities to feed a tremendous growing food demand. Consequently, agricultural land management has a strong impact on river's water balance and associated catchments (DeFries and Eshleman, 2004). During recent decades, concerns are mainly focused on changing patterns of land associated with deforestation and agricultural transformation. In extent, the most important form of land use is the expansion of crop and pastoral land in natural ecosystems. Raising concerns about environmental services globally speaking.

The consequences of agricultural practices on water supply and demand are high and they have a strong impact on local and downstream hydrological hazards as well as on biodiversity conservation (Thanapakpawin et al., 2007). Economic globalization also increases the in fluency of large agribusiness enterprises and international financial flows on local land use decisions, in some cases weakening national policies intended to promote a public good (Lambin and Meyfroidt, 2011). Quantitative assessment of agricultural intensification impacts on hydrological system can serve as a basis for developing watershed management schemes and decision support tools. Water quantity and quality are key environmental indicators which are sensitive to various external perturbations (Fan and Shibata, 2015).

Over the last decade, several research studies have been conducted in the field of agro-hydrology. But, extrapolating the results to other watersheds is not always feasible. This is mainly due to ungauged basins where the principal issue is the model calibration and the model sensitivity itself to changes in agricultural patterns and its relevance. Furthermore, contrast and identification of the human induced pressure from

the natural one will lead to a better understanding of the agro-hydrology interaction mechanics.

In the present chapter, we propose integrated modeling study by coupling the Decision Support System for Agrotechnology Transfer (DSSAT) (Jones et al., 2003) and the Distributed Runoff Evaporation and Antecedent soil Moisture (DREAM) Model (Manfreda et al., 2005) to assess the impacts of fertilizer application on runoff generation. The case study for model implementation and validation is a durum wheat agricultural (the Celone watershed, southern Italy).

## 2. Material and method

Tab. 15- Study materials and methods summary

Material	Descriptions
location	Celone at. san Vincenzo watershed
Region	Apulia region
Country	Italy
Goal	Impact of agricultural intensification on runoff generation
Mean	Fertilizer application as mean of intensification
Variable(s) analyzed	Leaf area index (LAI), runoff and discharge
Time frame	2000-2013
Crop seasons	Multiple discrete sequences
Hydrologic cycles	Multiple continuous cycles
Hydrologic model	DREAM Model
Implementation	Semi-distributed model
Spatial resolution	90 km
Temporal res.	Daily
Crop model	DSSAT-Ceres version 4.7
Implementation	Point base model
Spatialization method	Multiple fertilizer-based treatments
Temporal res.	Daily
Crop considered	Durum wheat

Coupling method	Loose coupling (One-way data exchange)
Data exchanged	Leaf area index
Execution order	Sequential
Data interpreter and converter	Custom MATLAB script

## 2.1. Study background

Coupling the DSSAT and DREAM models will allow to understand the effects of durum wheat cultivation and Celone's basin water balance. Assuming that farmers provide optimal conditions in terms of soil and pests management. The spatiotemporal distribution of rainfall and durum wheat growth impact the water distribution throughout land cover. Thus, the questions of how the intensification of crop growth impact hydrological regime, the effects of canopy cover development and leaf area index on water distribution and runoff generation and the relationship between crop development and runoff generation. Those are some of the potentially crucial questions to be answered to understand how rainfall distribution relies on agricultural intensification in this particular area.

## 2.2. Study case

Celone at. San Vincenzo watershed, Candelaro basin, Capitanata (Puglia, Southern Italy) is a typical Mediterranean climate, with warm to hot, dry summers and mild, wet winters (Fig. 30). Precipitation events are often characterized by heavy rain, with a high intensity during a short period of time (Iacobellis et al., 2015, Gioia et al., 2014), rainfall is unevenly distributed and often occurs as convective thunderstorms (Balenzano A., 2011, Fiorentino et al., 2011, Gioia et al., 2008, Manfreda et al., 2015). The Celone at San Vincenzo sub-basin is situated in mountainous areas characterized by Flyschoid formations. Soils predominantly belong to the class of Entisols (Andales et al., 2000) or Fluvisols (Gioia et al., 2011) and have a fine clayey-loamy texture, low organic matter content, poor natural fertility and lower water-holding capacity.

The watershed is characterized by intensive agriculture activity. It is one of the main zone for the production of durum wheat with 75% of the total basin area, followed

by broad-leaved forest (5%), annual crops (4%), land principally occupied by agriculture with areas of natural vegetation (3%) and olive groves (2.7%) (Diacono et al., 2012). The residential area covers less than 2% of the whole area (Gigante et al., 2009). Deciduous and mixed forests are present at the highest elevations where also some pasture lands can be found. The industrial activity is not relevant in this area.

The irrigation in the plain part of the watershed is managed by a local authority “Consorzio per la Bonifica della Capitanata” of Foggia (CBC), that gives irrigation water on demand through a pipeline network. In the areas equipped with the irrigation systems, the durum wheat is cultivated in rotation with tomatoes or sugar-beet. The sowing date for the tomatoes is generally in late April or after the harvesting of durum wheat in the rotation. A marked differentiation exists between seasonal and permanent vegetation (for instance between winter wheat and olives) (Gioia et al., 2012). During the winter season, the watershed is covered almost completely by rainfed cereal durum wheat. Planting is generally in November, while harvesting occurs during the summer, according also to the weather conditions. Tree crops, such as olives, grapes and citrus, have a lower percentages of vegetation ground cover (Gigante et al., 2009, Diacono et al., 2012).

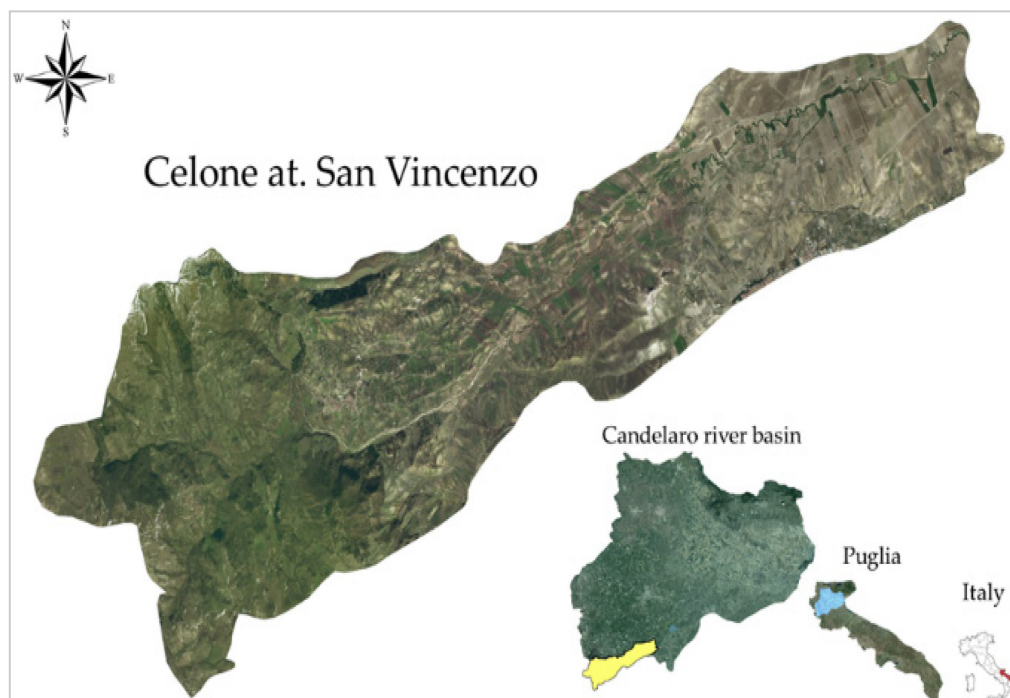

Fig. 30- The Celone at. San Vincenzo watershed.

## 2.3.Data

The hydro-meteorological data base, provided by the “Protezione Civile di Puglia”, it includes daily records of rainfall and discharge (Tab. 16), monthly minimum and maximum temperature and monthly wind. The spatial distribution of daily rainfall is accounted for by applying the Thiessen polygon method to the following stations (Orto di Zolfo, Biccari, Faeto, Orsara di Puglia and Troia).

Tab. 16- Hydro-meteorological data

Station name	Period observation	Parameters
Orto di Zolfo	2000-2013	Daily rainfall, min. max. and med. Temperatures, wind velocity and direction
Biccari		
Faeto		
Orsara di Puglia		
Troia		

S.Vicenzo	2000-2013	Daily discharge (discontinued records)
-----------	-----------	--

The hydraulic properties of soils are assigned from the “HarvestChoice Project” at International Food Policy Research Institute (IFPRI) in collaboration with International Research Institute (IRI) at Columbia University and Michigan State University (A Global High-Resolution Soil Profile Database for Crop Modeling Applications Version 2.4 database at 5’ spatial resolution) (International Research Institute for et al., 2015). This allows a priori estimates of parameters such as: porosity of soil, field capacity, wilting point, saturation, soil depth (cm), soil permeability (mm/day).

Experimental data required for durum wheat cultivars are taken from previous study conducted by (Dokoohaki et al., 2015, Ventrella et al., 2012), where the “Simeto” cultivar is referenced as the most spread and largely used by the farmers of Celone. The studies provide assessment of DSSAT’s Ceres-wheat based on several years of calibration and extensive experimentation data.

The level-4 MODIS global LAI and Fraction of Photosynthetically Active Radiation (FPAR) product (MOD15A2) is provided every 8 days at 1-km resolution on a Sinusoidal grid. Science Data Sets available in the MOD15A2 dataset include LAI, FPAR, a quality rating and standard deviation for each variable. Version-5 MODIS/Terra LAI products are “Validated Stage 2”; accuracy has been assessed over a widely distributed set of locations and time periods via several ground-truth and validation efforts (Disney et al., 2016). MODIS LAI data images were collected over a time span of 13 years (2000–2013) to characterize the changes in land vegetation cover. Lastly, using the capabilities of the MODIS Reprojection Tool, the data were projected in the cartographic reference system WGS 84 zone 33 Nord from the original MODIS Sinusoidal Projection System.

## 2.4. Modeling framework

The coupling framework schemed in Fig. 31 allows quantify the effect field level management on hydrological cycle and quantify its impacts. Preliminarily, a set of

scenarios are defined and implemented in DSSAT. Using MODIS satellite LAI images, the planting date is calibrated for all the cases uniformly using the method described in *Chapter V*. Then DSSAT is coupled with the DREAM model using a custom MATLAB script that allows integration of DSSAT's LAI into DREAM. The implementation is done at a grid base where both models operate sequentially (Fig. 32).

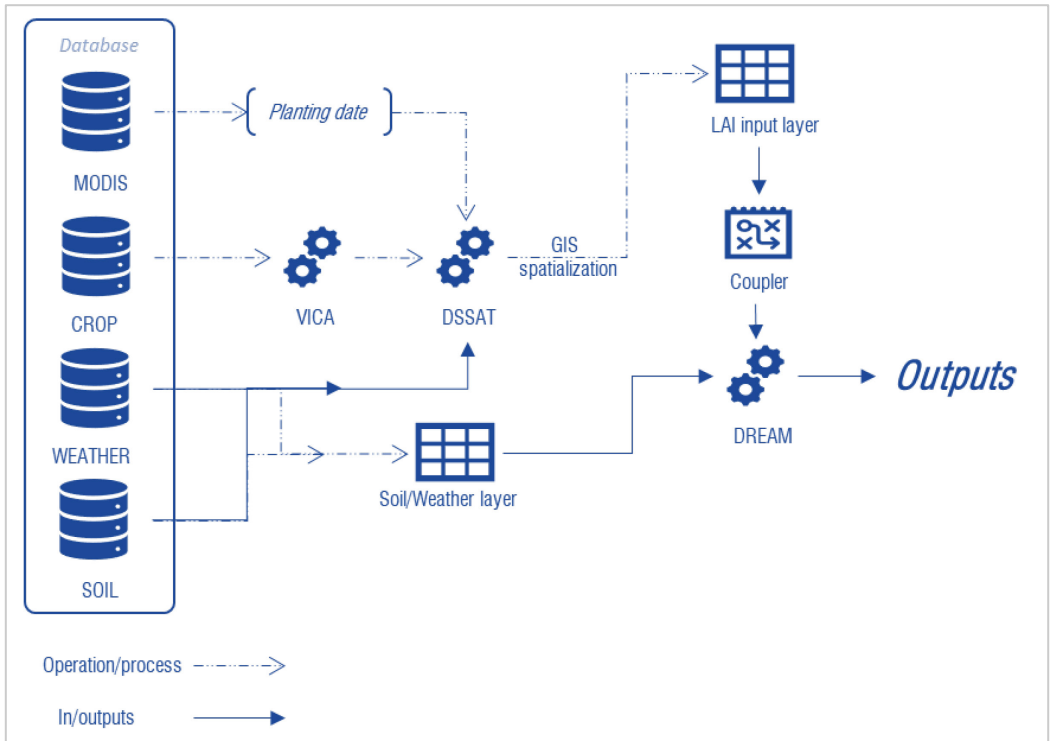

Fig. 31- DREAM-DSSAT coupling framework

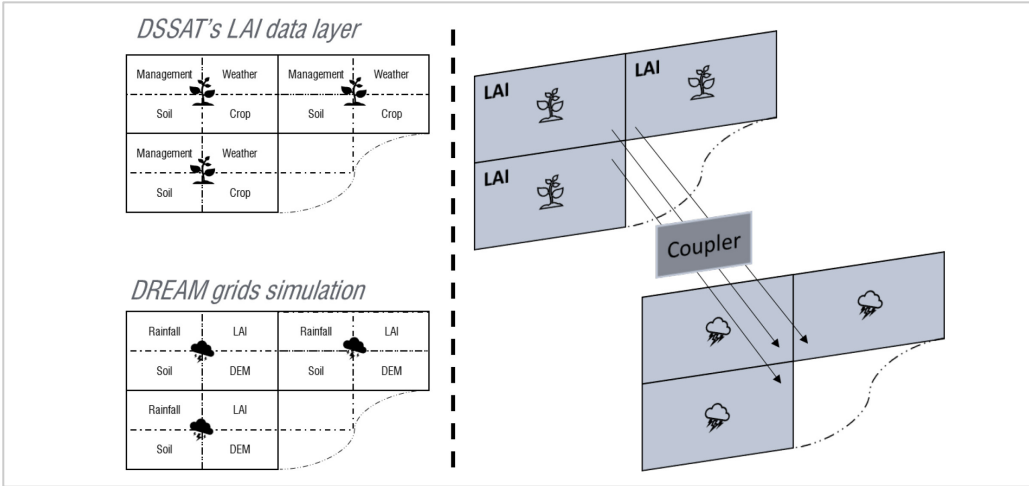

Fig. 32- Layers structure and data coupling

Using a performance-based approach, the implementation is reversed to extract the management candidates that fit best simulated discharges based on DSSAT's LAI data (Fig. 33).

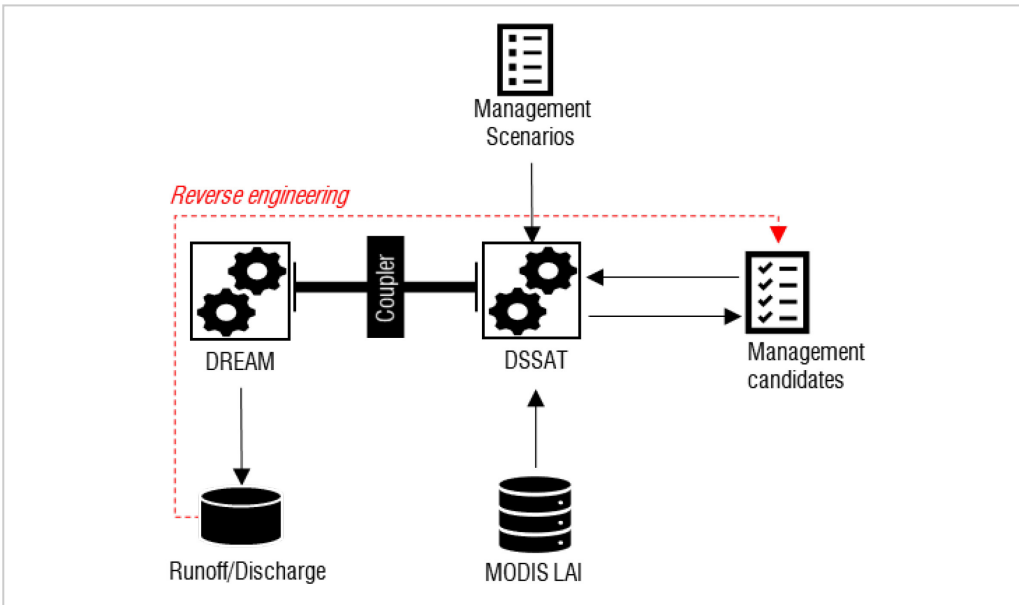

Fig. 33- DREAM-DSSAT modeling framework

## 2.4.1. Model presentation

### 2.4.1.1. The DREAM model

The DREAM model is presented as a MATLAB code, it includes two sub-models operating at distinct time scales. Daily-DREAM (D-DREAM) model is mainly designed to reproduce daily runoff and soil dynamics. When a given threshold of rainfall is exceeded, a different module (Hourly-DREAM, in the following H-DREAM), reproducing the flood event at an hourly step, becomes operative. DREAM simulations are compound by the alternation of D-DREAM and H-DREAM runs or otherwise the two models may be applied separately. In both cases, the hydrological processes are computed on a grid-based representation of the river basin. But for our purpose, we will limit the simulation to the daily time step. Data concerning vegetation coverage, soil texture, local slope, etc., are required for each cell.

### 2.4.1.2. The DSSAT model

The Decision Support System for Agrotechnology Transfer (DSSAT) is a computer application program that comprises crop simulation models as well as tools to facilitate effective use of the models. The crop simulation models simulate growth, development and yield as a function of the soil-plant-atmosphere dynamics. The models require daily weather data, soil surface and profile information, and crop management as input. Crop genetic information is defined in a crop species file that is provided by DSSAT and cultivar or variety information that should be provided. The simulations are conducted at a daily step. at the end of each day, the crop's vegetative and reproductive development stage are updated.

## 2.4.2. Procedure

Being a point-based model, DSSAT spatialization without having to use a third part tools requires to define a set-up of experiments that must be representative of the existing spatial homogeneity. We divided the watershed according to two criterions: the soil variability and the weather station covered (Fig. 34).

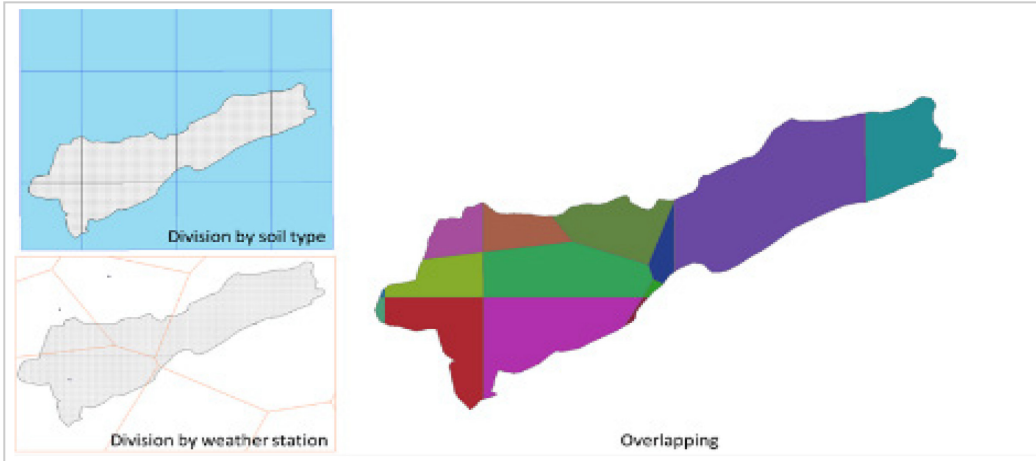

Fig. 34- Celone's division For DSSAT spatialization

Over the entire watershed, 6 different soils and 5 weather stations are selected (Fig. 35). The overlapped polygons' maps, prepared in ArcGIS, provides 14 different homogenous zones in terms of soil and weather. In addition, to assess the level of intensification reached in the region, 8 level of fertilizer supply (i.e.: 0 kg/ha, 30 kg/ha, 60 kg/ha, 90 kg/ha, 120 kg/ha, 150 kg/ha, 180 kg/ha and 210 kg/ha) were set for all the experiments.



Fig. 35- soil and weather station distributions

IT\*\*\*\*\*: Soil type codename

Following the same procedure, the DREAM'S data inputs scheme was prepared using raster maps (Fig. 36). The cells are 90 m spatial resolution.

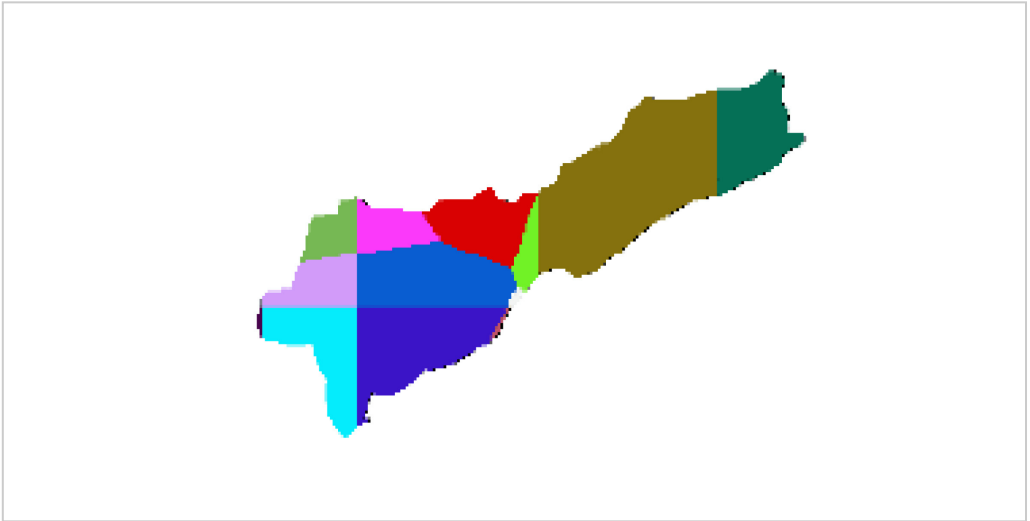

Fig. 36- DREAM's raster's inputs based on soil-weather homogeneity

## 2.4.3. Models' setup

### 2.4.3.1. DSSAT

#### Method for soil organics carbon

The simulations were done with the setting of organics carbon to “Ceres-Godwin” for both calibration of Simeto cultivar and scenarios.

#### Soil initial conditions

The soil chemical composition is set as in the following table. NO<sub>3</sub> and NH<sub>4</sub> are assumed to be reset to zero for soil N balance (Tab. 17).

The following table shows the input soil file of DSSAT used to generate the scenarios.

Tab. 17- Initial soil conditions

PC	ICDA	ICRT	ICN	ICR	ICR	ICW	ICRE	ICRE	ICRE	ICRI	ICRI	ICNAM
R	T		D	N	E	D	S	N	P	P	D	E
WH	**24	-99	-99	1	1	-99	-99	-99	0	-99	-99	-99

ICB	SH2	SNH	SNO
L	O	4	3
5	0.23	0	0
15	0.23	0	0
30	0.23	0	0
45	0.23	0	0
60	0.23	0	0
75	0.23	0	0
90	0.23	0	0
120	0.23	0	0
150	0.23	0	0

### Cultivar coefficient

The cultivar coefficients were estimated using the original experiments obtained from Dr. Michele Rinaldi. His experiments were conducted in 1991, 1992 and 1993 in the region of Foggia, southern Italy. VICA is used to estimate the coefficient showed in Tab. 18

Tab. 18- Simeto cultivar coefficients

Coeff.	P1V	P1D	P5	G1	G2	G3	PHINT
Unite	Vday	%/10h	o.C.d	#/g	mg	g	o.C.d
Value	1.018	69.52	616.2	30	35	1.0	60

An example of application for the season 2007-2008 is provided in Ane. 1 through Ane. 5.

### 2.4.3.2.DREAM and Coupler

Being the host model of the coupling, DREAM source code was changed extensively. Along with coupler itself written in MATLAB, the following changes, but not limited to, were added the DREAM model:

1. Upgrade from monthly based simulation to daily
2. Addition of DSSAT's outputs reader
3. LAI input maps were replaced with DSSAT's LAI with coupler routine.

The coupler is a MATLAB script for DSSAT's LAI rasterization, parallel execution and file editing. The coupler generates daily DSSAT's LAI grids for each polygon of the Celone's map.

## 3.Results

### 3.1.Simulations

#### 3.1.1.DREAM model

D-DREAM run was performed for the period 2000-2013 at daily basis. Where the years for which recorded discharge, data were used for model calibration. The soil moisture content at the beginning of the calibration period was arbitrarily assumed equal to the field capacity. Notwithstanding the unreliability of the choice, the length of the calibration period and the good quality of results hereafter indicates that model performances are not affected by such initial condition. Simulations results are displayed in Fig. 37. Comparing simulated versus measured time series, both relative to the entire record of observation, we obtained satisfactory results. The KGE coefficient is always above 0.85 (for the years where records are available).

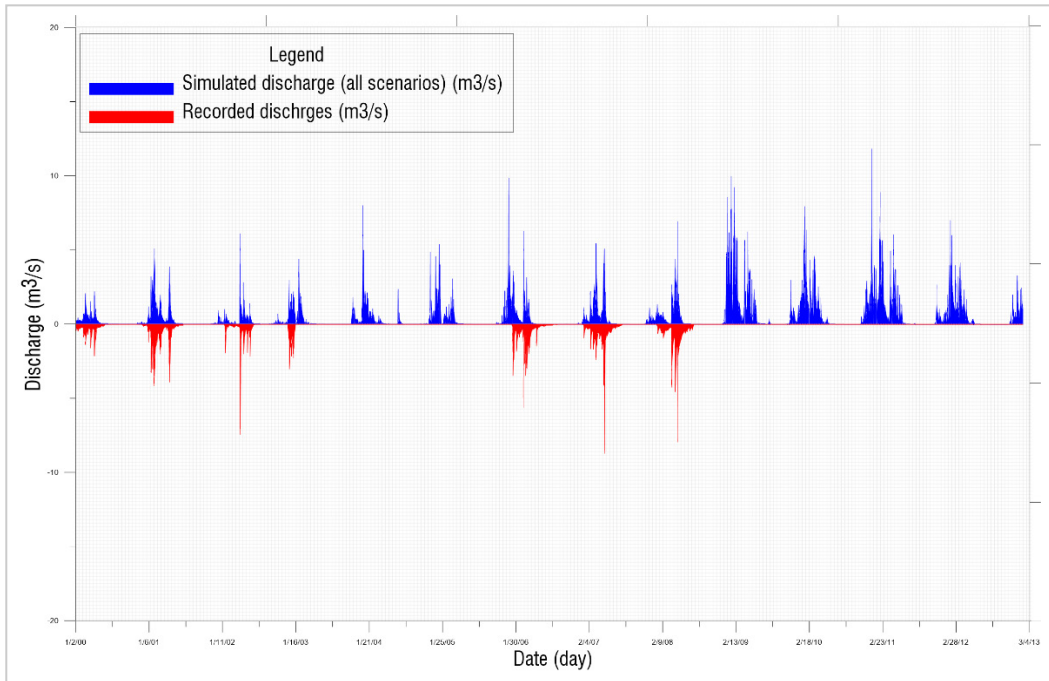

Fig. 37- Simulated vs. recorded discharges for the Celone watershed (2000-2013)

The runoff coefficient in Fig. 38 (Calculated by mean annual discharge and annual rainfall) shows a distinctive breakpoint in 2006. Followed by a continuous increase with a peak in 2009. Apart from rainfall characteristics such as intensity, duration and distribution which are responsible of runoff generation and variation at a relatively long-term observation. There are several sites (or catchment) specific factors which have a direct bearing on runoff occurrence and fluctuation at a shorter time. Considering the vacation of the watershed, land use and management is the first parameters to consider for investigation.

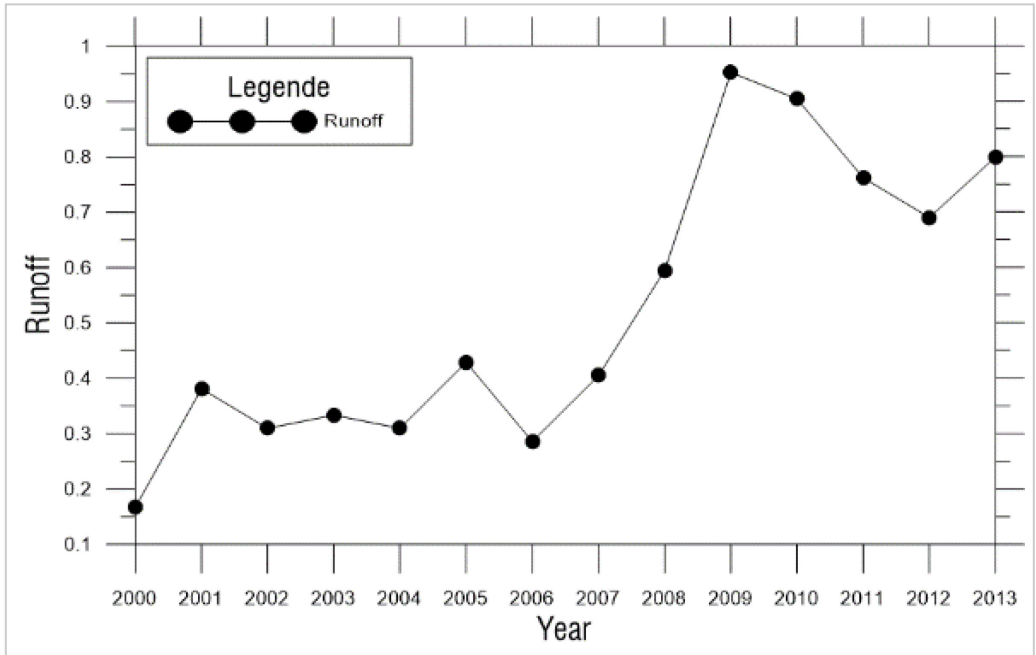

Fig. 38- Average yearly runoff of the Celone watershed

### 3.1.2.DSSAT model

Fig. 39 shows the variation of LAI for the different setup scenarios. As the N application increases the biomass production follows the same trend. Nonetheless, as the N application increases, Fig. 40 and Fig. 41 show a saturation effect where we observe a constant linear response of LAI in respect to N. This phenomenon is also observed for yield production and its N productivity (Fig. 42 and Fig. 43).

This response is purely related to the DSSAT-Ceres model and the implementation of plant response to N application. The model uses common soil C/N and water models, which integrate mathematical equations to describe the basic flow and conversion processes of soil carbon, water and nutrient balances on a daily or hourly basis. At the same time, it also predicts the temporal changes in crop growth, nutrient uptake, water use, final yield as well as other plant traits and outputs.

N concentration in plants' leaves is a factor that determines the amount of Radiation Use Efficiency (RUE) and biomass productivity. The accumulation of large amounts of N in leaves is essential for high biomass and grain yield and higher amounts of N are commonly associated with high harvest indices.

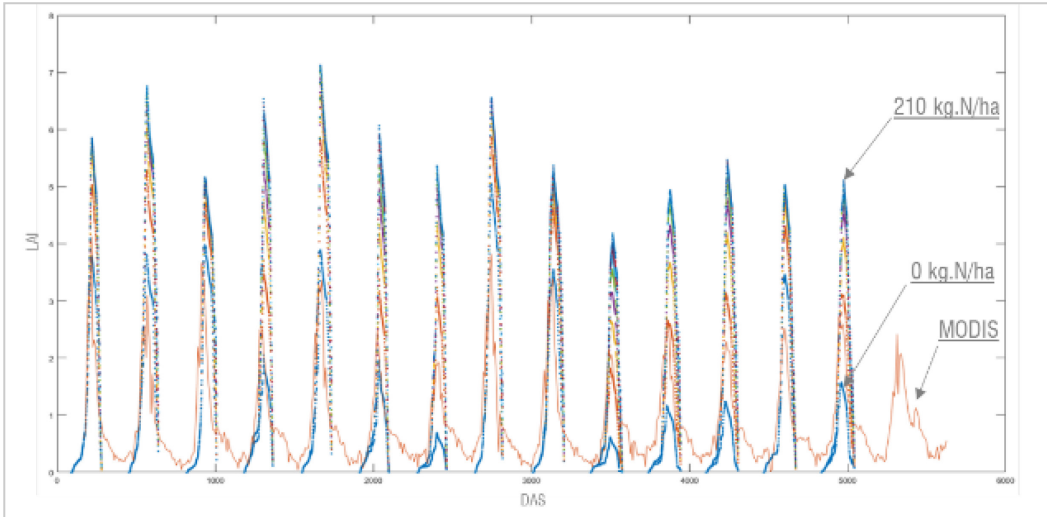

DAS: Days After Sowing  
 Fig. 39- MODIS vs. DSSAT's LAI for different scenarios

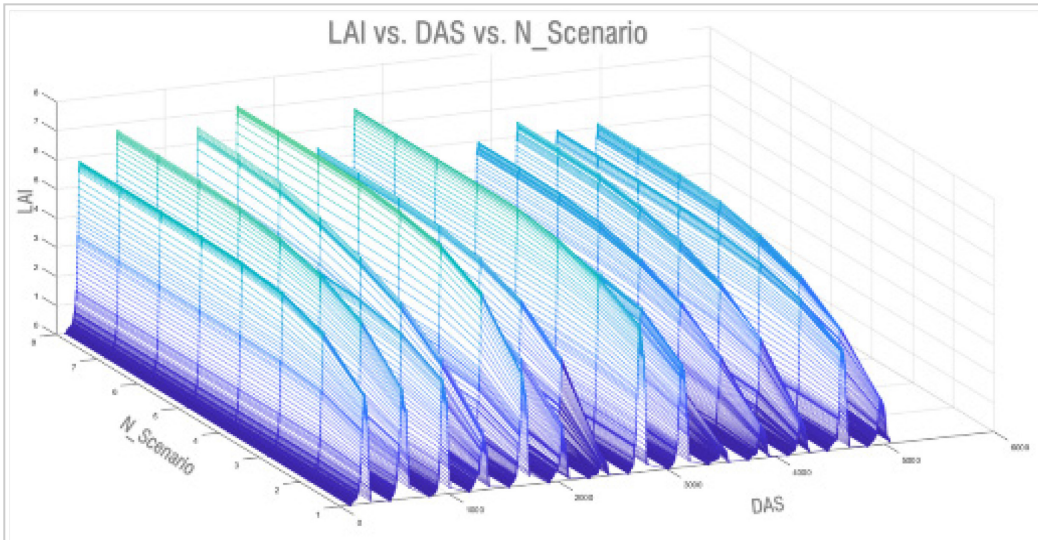

Fig. 40- LAI relation to N application for the different scenarios  
 \*N\_Scenario: Nitrogen application scenario

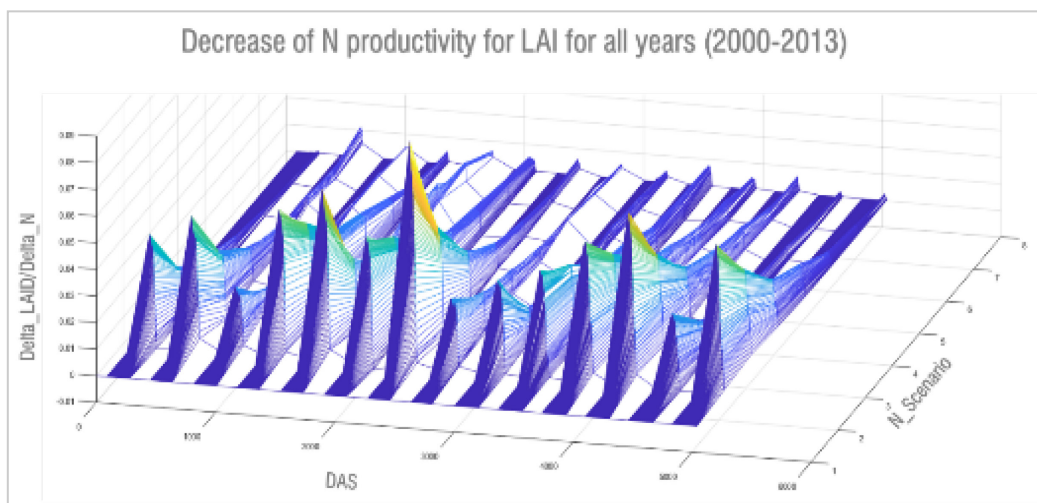

Fig. 41- N productivity for LAI

\*Delta\_LAI: variation difference of leaf area index between two successive scenarios

\*Delta\_N: difference between two successive N scenarios application.

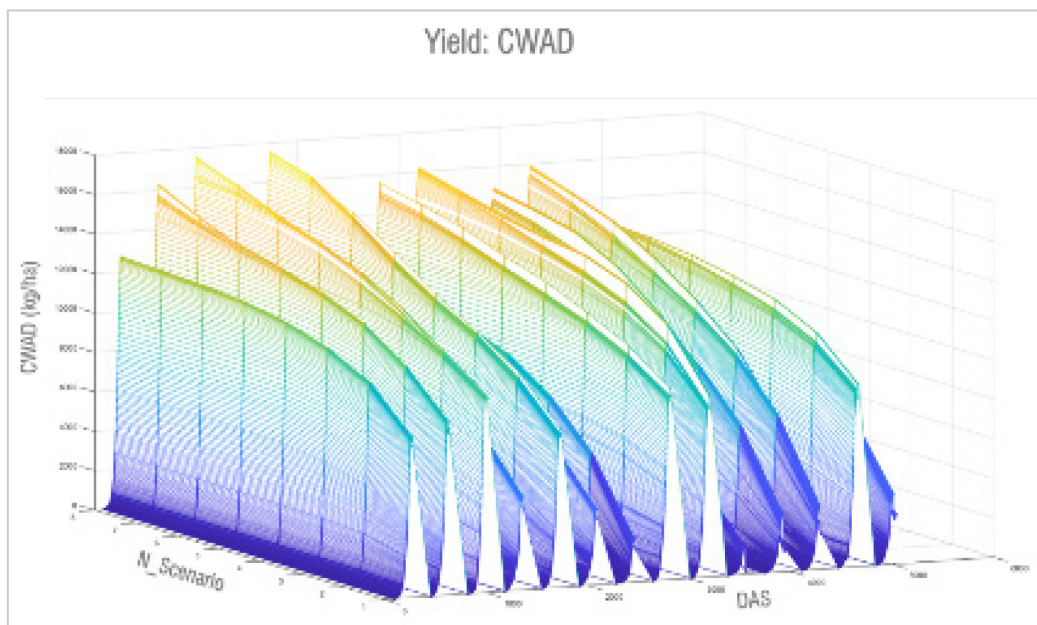

Fig. 42- Yield relation to N application for the different scenarios

\*CWAD:Yield

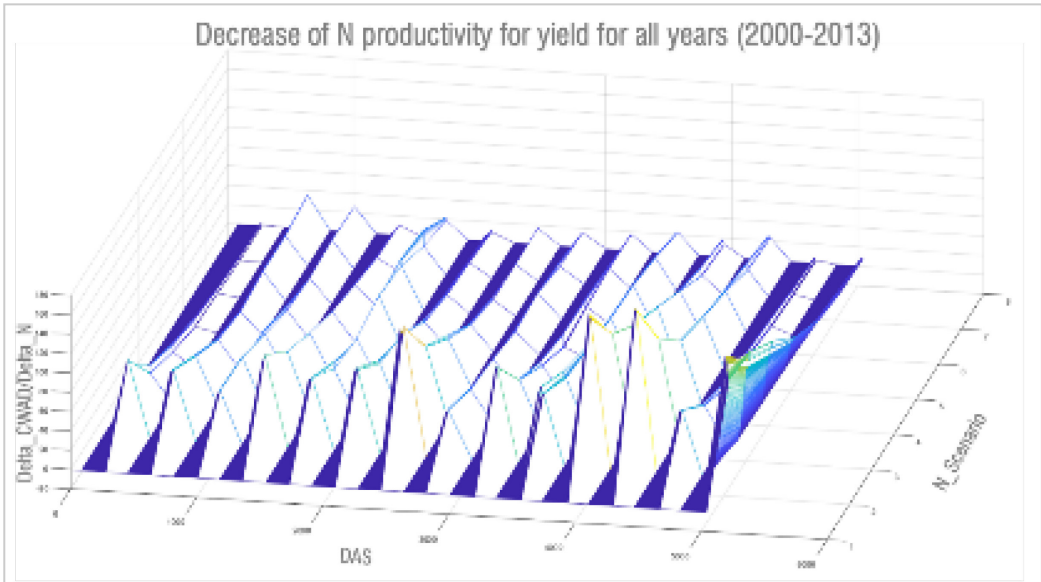

Fig. 43- N productivity for yield

### 3.1.3.DREAM-DSSAT coupled model

Results of **Error! Reference source not found. Error! Reference source not found.** simulations are displayed in Fig. 44. For all the scenarios, we observe an inverse response for discharge generation. Indeed, an increase in LAI lead to a reduction in discharge. This response is explained by the principle implemented within DREAM modulization of water balance and the amount of canopy interception, storage and evaporation. Such as:

$$Eq. 16: w_{sc} = 0.2 * LAI (mm)$$

Where:

$w_{sc}$  : Water bucket of limited capacity

The canopy water content:

Eq. 17:  $\frac{\Delta w_c}{\Delta t} = p_v - e_{wc}$

Where:

$p_v$  : The interception rate and  $e_{wc}$  is the direct evaporation rate.

Direct evaporation of water from the canopy is computed as:

Eq. 18:  $e_{wc} = (w_c/w_{sc})^{2/3} * e_{wct}$  if  $w_c > 0$

Where:

$(w_c/w_{sc})^{2/3}$  : Ratio of wet canopy

$e_{wct}$  : Potential evaporation rate from the entire canopy.

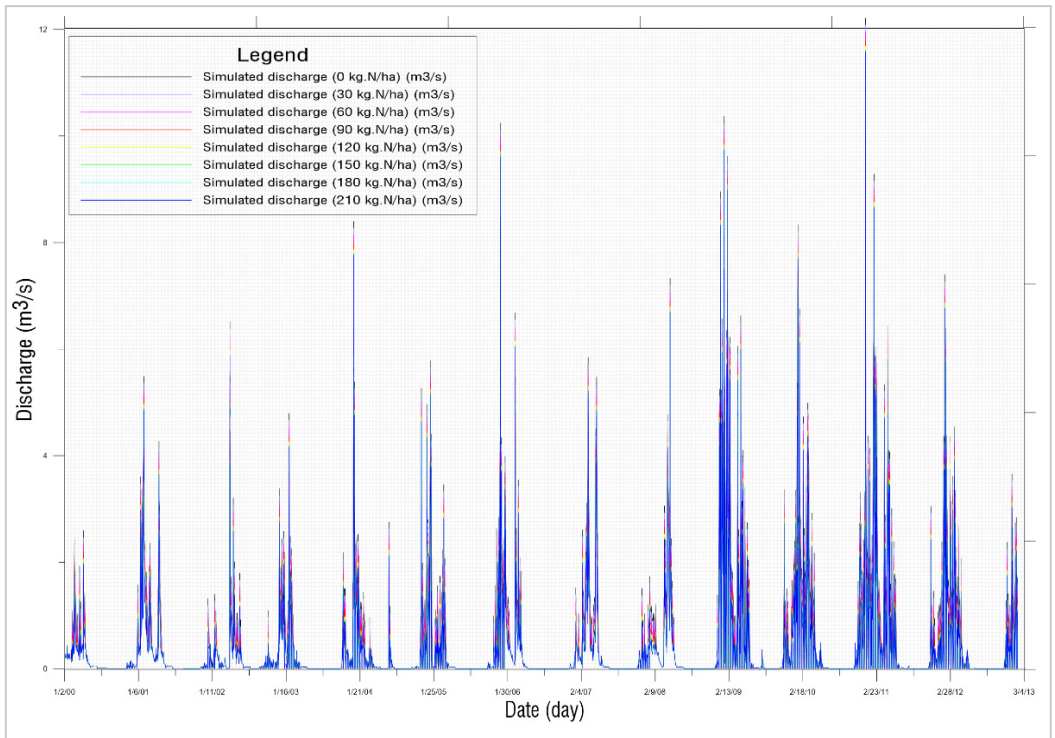

Fig. 44- Scenarios' simulated discharges for the Celone watershed (2000-2013)

### 3.1.4.Reversed DREAM-DSSAT coupled model

The coupling framework was inverted to extract scenarios that fits best recorded discharges at yearly basis. Fig. 45 shows the different N scenarios candidates that best fit the simulated discharges. A break in trend is observed throughout the period 2007-2008 anteceded by a generally decreasing trend from 2000 to 2006. After 2008, the trend is relatively of slight increase.

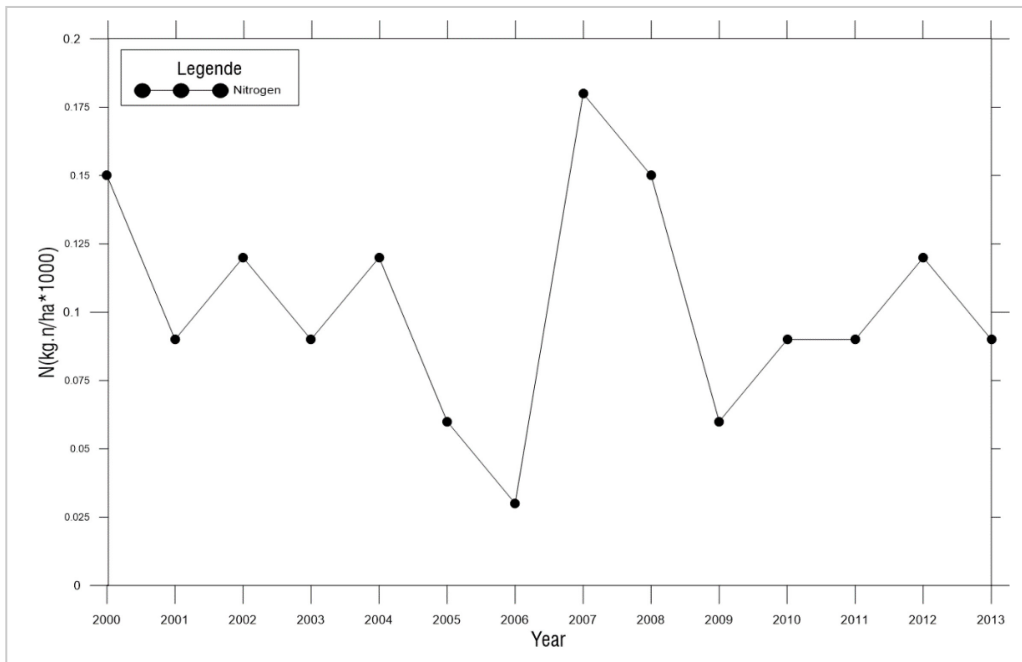

Fig. 45- N application candidates for the period 2000-2013

As expected, the trend variation is like the LAI one (Fig. 46). Particular attention is given to the maximum values achieved throughout the successive seasons, where the similar trends variation correlate with the fertilizer application level (Fig. 47). This correlation demonstrates the relevant effect that management has on the vegetation dynamics and that agriculture is the dominant land use in this area.

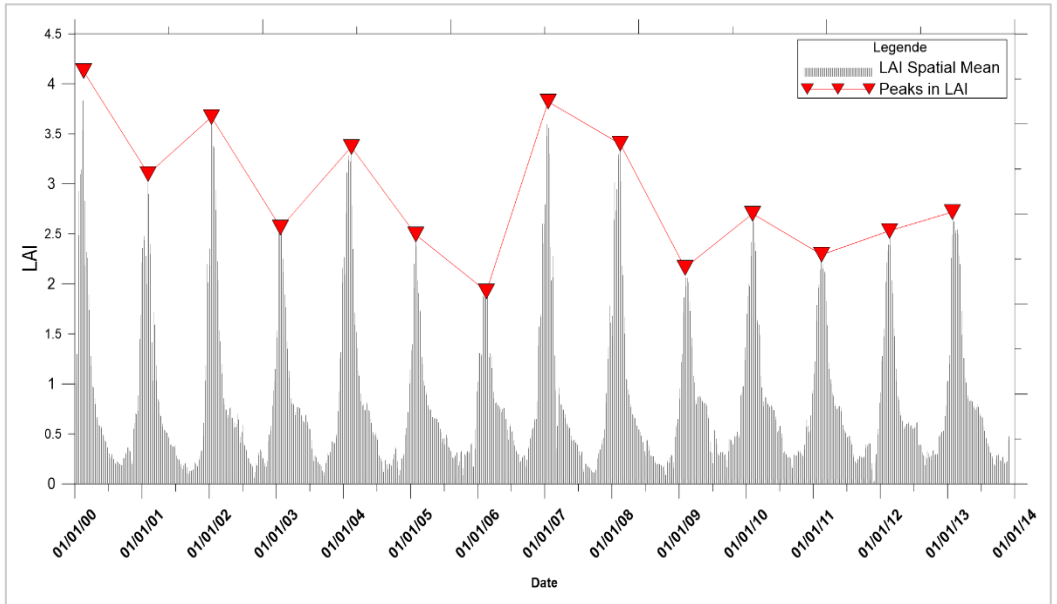

Fig. 46- LAI spatial mean 2000-2013

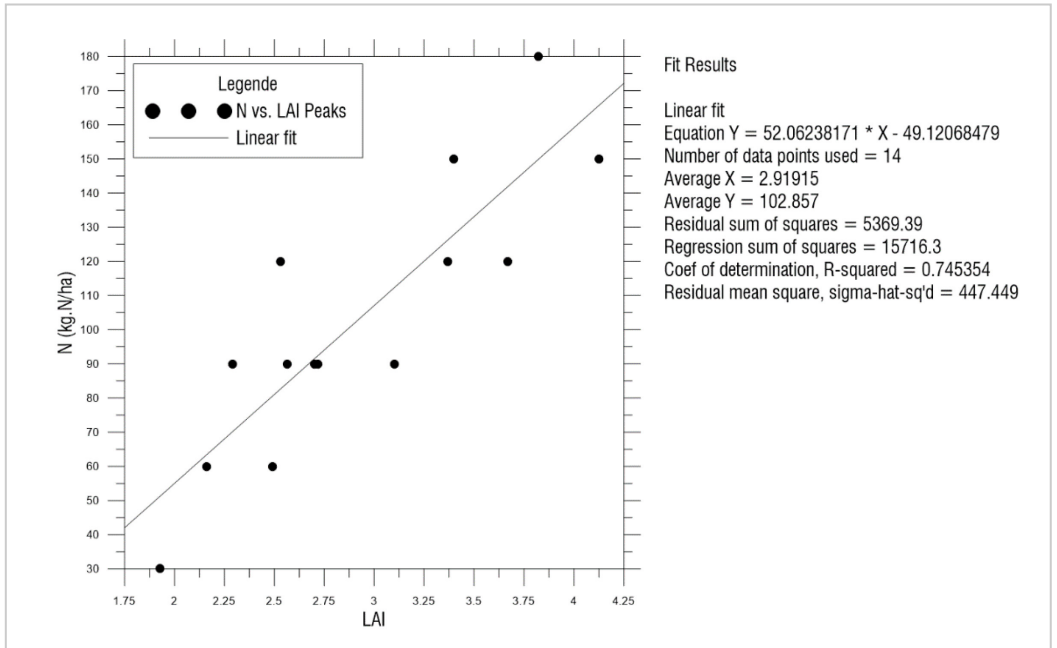

Fig. 47- N vs. LAI

### 3.2. Analysis

As the LAI increases, the water stored and prone to be evaporated and stored follow the same trend. It is known that at an annual scale, it may be responsible for losses reaching 20% of the total precipitation (Chang, 2012). This phenomenon is observed in Fig. 48, where 19% of the total volume through the entire period of simulation is lost between the scenarios one, with 0 kg.N/ha, and eight, with 210 kg.N/ha, which represent over 200 million m<sup>3</sup> in terms of volume. In other words, 15 million m<sup>3</sup> as average in yearly basis and nearly  $71.5 \times 10^3 \text{ m}^3 / \text{kg.N.ha.year}$ .

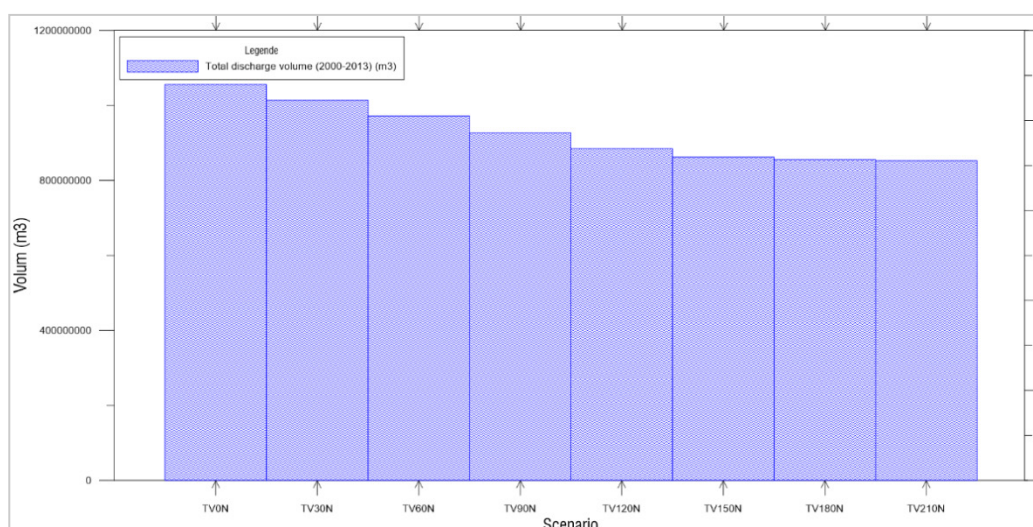

Fig. 48- Total discharge volume 2000-2013 for the all scenarios

\*TV0N, ..., TV210: Total discharge volum for the different scenarios

This loss in discharge volume is interestingly found to be not linearly proportional to the increment of N application. Fig. 49 shows that it has it peak between scenario 4 and 5, with 60 and 90 kg.N/ha applications respectively. This response translates the saturation effect observed in LAI production.

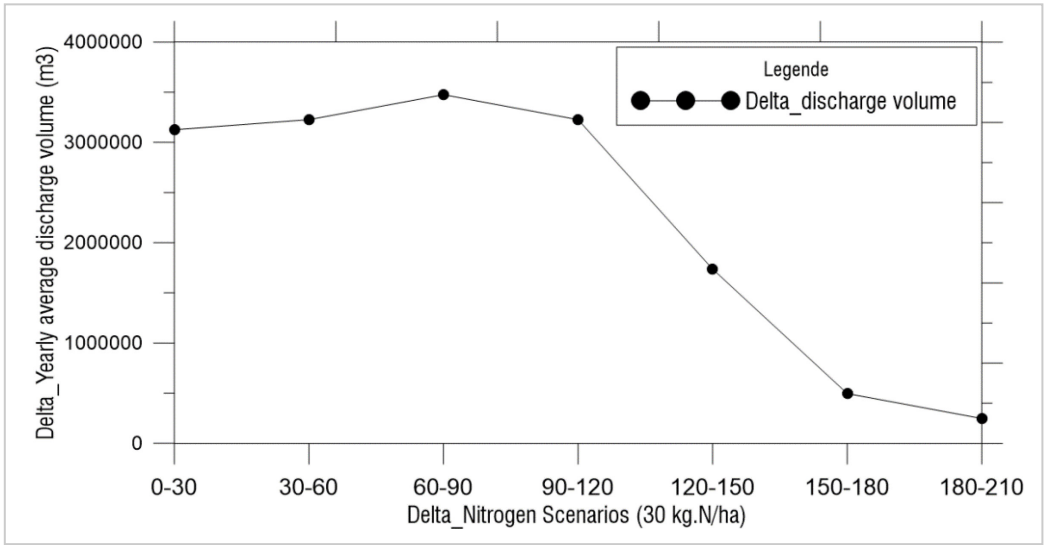

Fig. 49- Discharge volume gain/loss vs. increment in N application

\*Delta\_discharge: difference in discharge volum between two successive scenarios

\*Delta\_Nitrogen: difference between two successive nitrogen application scenarios

Fig. 50 shows the ratio of runoff respectively to the average N application scenario for each its corresponding year. It is worth notice that the overall proportionality is continuously increasing over the years. Nonetheless, is has noticeable higher variability after 2006.

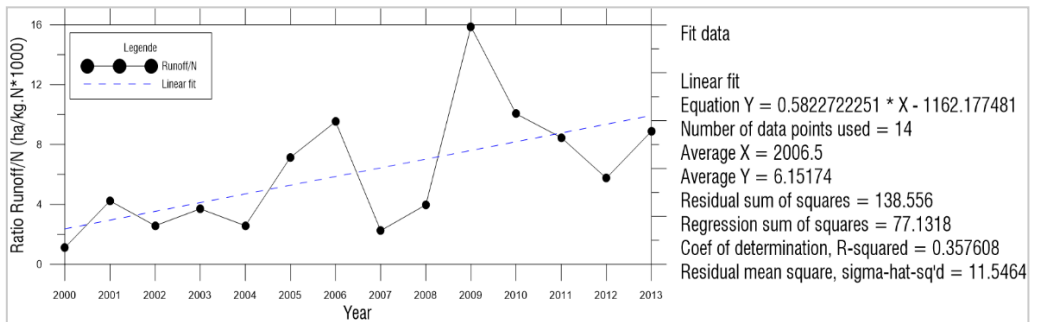

Fig. 50- Ratio runoff/N for the period 2000-2013

Interesting insights is drawn from the scattered plot shown in Fig. 51 between runoff and N application. Two distinct relationship are observed over the period of

investigation. R1 and R2 correspond to linear relationships between N and runoff coefficient for 2000-2006 and 2007-2013 continuous timeframe respectively. The linear correlation had strengthened significantly after 2006. Indeed,  $r^2$  increased from 0.3 for R1, to 0.93 for R2. In the other hand, the yearly average N applied had increased by 18% where runoff by 128% runoff from 2000-2006 to 2007-2013.

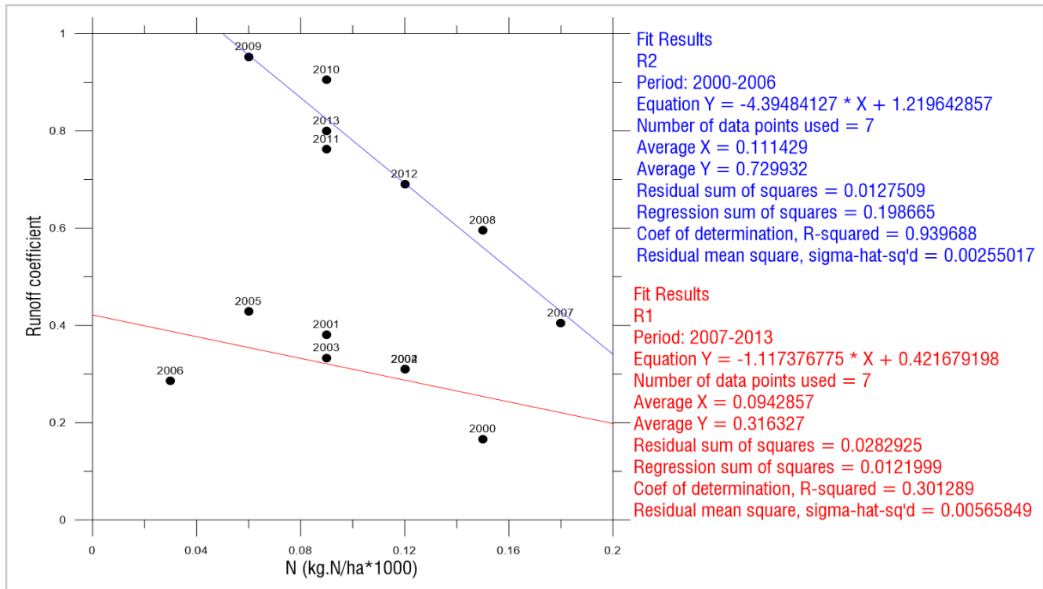

Fig. 51- Runoff vs. N

To assess the process of watershed's runoff response to N application, we calculated the first finite difference of runoff with respect to N. The results are shown in Fig. 52. The positive values in the first finite difference indicate the same trend variation of runoff and N, and inversely for the negative values. Through the entire period, we noticed that before 2006 and starting from 2008 a positive correlation. This means that an increase (or decrease) in N induces the same variation in runoff. Between the seasons 2005-2006 and 2006-2007, we observe inverse trends (negative values). According to Fig. 51, 2006 and 2007 belong to distinctive relationships between runoff and N (i.e: R1 and R2) and the inverse trends could be led by a variation of cultivated area. Indeed, from 2005 to 2006, Fig. 52 shows a decrease in N applied and this results

in a decrease of runoff. More area is covered with vegetation, yields less runoff than the bare one.

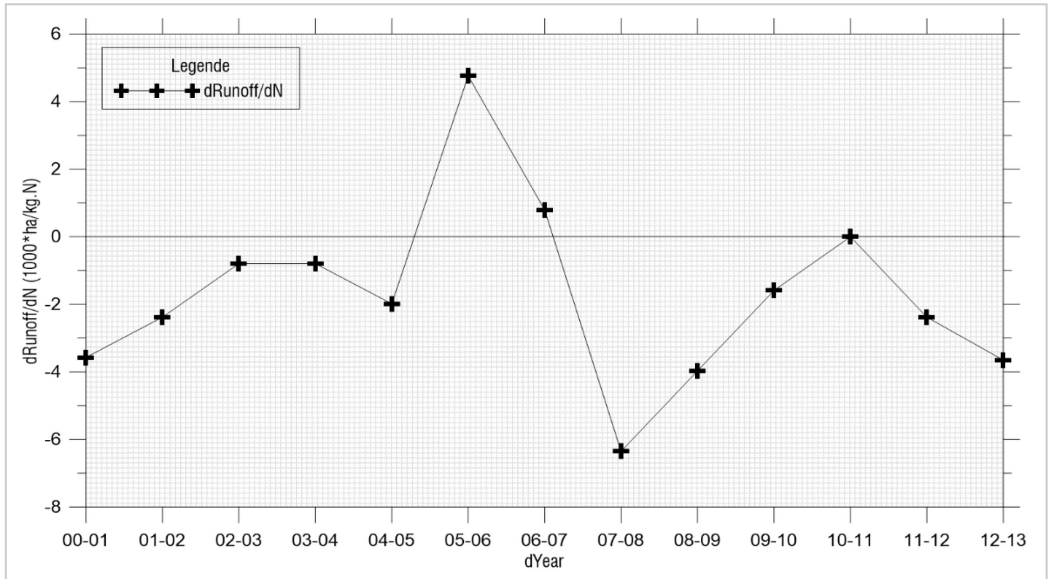

Fig. 52- Finite difference of N application and runoff production

\*dYear: difference in yearly calendar; dRunoff: difference in yearly runoff; dN: difference in yearly N application

#### 4. Discussion and conclusion

In the present chapter we undertook an integrated modeling work in order to establish the relationship between runoff generation and N in the Celone watershed. The modeling framework consists of coupling the DREAM hydrologic model and DSSAT-Ceres model. The coupling method used is the one-way data exchange. Prior coupling, a common a spatio-temporal framework of operation at grid level and daily step base was established and both models have been upgraded to match it. Afterward, the framework coupling was reversed to extract N application that matches simulated discharges.

The LAI analysis in respect to N application scenarios provided expectable results. Indeed, the increase in N correspond to an increase of LAI. Nevertheless, the

relationship between LAI and N is not linear, and above 90 kg.N/ha, a phenomenon of saturation is observed where a significant reduction in LAI tendency variation in respect to N scenario. This phenomenon is a plant physiological aspect that is implemented within the DSSAT-Ceres model.

The volumetric analysis over the period of study shows that the ratio gain/loss of rainfall water is not linearly proportional to the amount of N applied. Indeed, the conjugated effect of N saturation along with the DREAM canopy bucket water balance show that much of the volume is gained/lost above the scenario 5 that correspond to 90 kg.N/ha. A significant the annual average gain/loss factor for N application was estimated over the study period to  $71.5 \cdot 10^3 \text{ m}^3/\text{ha.kg.N}$ . Considering the price of irrigation water in Italy, 0.01-0.8 €/m<sup>3</sup>(Giannakis et al., 2015), this represent in monetary value a 715 €/ha.kg.N up to 57 200 €/kg.N.ha.

Interesting insights were identified in order to establish the relationship between runoff and N in the Celone's agricultural watershed. Two distinctive relationships over the study period were established between runoff and N (RON1 and RON2). The correlation coefficient was found significantly higher for RON2 with 0.93 respectively to RON1 with 0.3, along with significant increase in the average N applied over the corresponding timeframe (2000-2006 and 2007-2013). For almost the entire period, we observed a positive response of runoff changes respectively to N, the exception is underline for the seasons 2005-2006 and 2006-2007.

It is worth mention the similar results found by (Siad et al., 2017). Indeed, the research findings show that the policy changes implemented by the CAP program explain the correspondence of the trend between market price, durum wheat LAI, the land use and the farmers in the Celone watershed. In addition, the farmers of Celone showed a positive response to the CAP reforms in terms of land management and production. The land allocation and the intensification of durum wheat cultivation was found in accordance with the CAP intervention.

---

## *General conclusion*

---

## General conclusion

The study of linkages between crop and hydrologic processes has a relatively long history based on modelling, experimental work, watershed analyses and measurements. Nevertheless, hydrological studies have received little attention as far as agricultural practices impacts assessment are involved. This thesis tried providing a modest contribution to these types of studies and research.

The reviews studies involving coupled hydrologic and crop growth models' coupling, even if still not exhaustive, provides useful examples for practical information and purposes of this new tendency in model development. It can be of interest for researchers, practitioners, and policy-makers involved in agro-hydrologic studies and projects. Particularly, it may help understanding the potential benefit raising from incorporating crop models in hydrologic simulation for water resources conservation, sustainability and performance improvement of crop and irrigation systems.

DSSAT parallelization provides a great opportunity for model spatialization. Climate data are now becoming more readily available as gridded data (current and future climate scenarios) (Weedon et al., 2011), and soil profiles can be synthesized effectively at each grid cell (White et al., 2008b; Wu et al., 2010a, 2010b). However, defining management interventions for each cell is a major constraint.

VICA algorithm bases its iteration on reducing the error function on the cultivar coefficients intervals, crop development strategy is an important aspect that is not transcoded within VICA and further research and investigation is needed in setting cultivars intervals. Nevertheless, DSSAT's experiments database provide a valuable starting point and provides a guideline on cultivar coefficients and their inter-relationship.

Remote sensing data presents a great option for management practices data retrieval. An example was presented for planting date investigation, using MODIS's LAI product. It is worth mention that outside of controlled experimental trails, crop planting

date in crop models is always a result of assumptions based on diverse criterion as saw in *chapter V*.

The Celone watershed comprises complex and adaptive agricultural system. With the strong agricultural activity involved, the yearly average runoff is directly affected by N application. The system level patterns in hydrology (i.e. runoff) emerge from actions and interactions of autonomous agents and could not be predicted from examining and aggregating their individual behavior.

In conclusion, the impact assessment procedure throughout the integration of crop and hydrologic models, which are based on a quantitative understanding of underlying processes of integrated effects of soil, weather, crop and management factors on growth and hydrologic regime allowed a better understanding of the complex dynamic of the hydro-agricultural system with its heterogeneity and interactions between runoff and N application management decision.

---

*Recommendations and further  
works*

---

## Recommendations and further works

In this work we synthesized the current state-of-the-art advancement in technologies used to simulate integrative agro-hydrologic systems. Nonetheless, models' integration is not a straightforward task and still challenges researchers on many aspects. Such as estimating of uncertainty or error covariances between models' resolution interaction and parameterizations at the interfaces between components of coupled models.

Current data exchange-based coupling methods are not suitable to simultaneously analyses multiple spatiotemporal scales. Indeed, there is no standardization of observation data or their delivery systems across models. The size and complexity of large-scale coupled agro-hydrologic models make difficult to investigate uncertainty due to sensitivities in models' parameters and coupling parameters. Indeed, the errors lead to local biases that can transfer between different models' components can lead to coupled models' biases and long-term model drift.

Favor community-based models' integration to legacy one. This will facilitate exchange, maintenance and support access for the coupled models and the users by first gathering expertise before the models themselves.

Further work is needed to:

- understand information propagation across models' components with different spatiotemporal and scales for error estimation and improvement.
- Improve and advertise community-based models for cross disciplines that will accelerate models' development and facilitate cross boundaries integration.
- How to concretize models results to formulate decision support for policy improvement to enhance crop system performance and preserve resources.

---

## *Acknowledgements*

---

---

# *Acknowledgements*

---

## Acknowledgements

### Acknowledgements

I am deeply indebted to my advisors Prof. Vito Iacobellis and Prof. Gerrit Hoogenboom for their fundamental role in my doctorate. They provided me with every bit of guidance, assistance, and expertise that I needed during my work; and when I felt the need to venture into research on my own, they gave me the freedom to do undertake, at the same time continuing to provide me with valuable feedback, advice, and encouragement. In addition to our academic collaboration, I greatly value the close personal rapport that we have that I can't forged over the years.

I would like to thank the Polytechnics University to have funded my work and which without, it wouldn't be possible. I would like to thank also the DICATECh and ABE departments along with the DSSAT foundation members to have offered me the academical structures, facilities, training, courses and materials to accomplish it. I would particularly like to acknowledge Andrea Gioia, Sheryl Porter, Vakhtang Shelia, Ken J. Boote. Ilan Stavi and Pandi Zdruli for their collaboration and support.

I am deeply thankful to my parents, sister and brothers for their love, support, and sacrifices. Without them, this thesis would never have been written. I dedicate this thesis to my little brother Rayane, I found in him all the reasons, determination and will to take up all challenges.

---

# *Annexes*

---

---

# Annexes

---

Annexes

Annexes

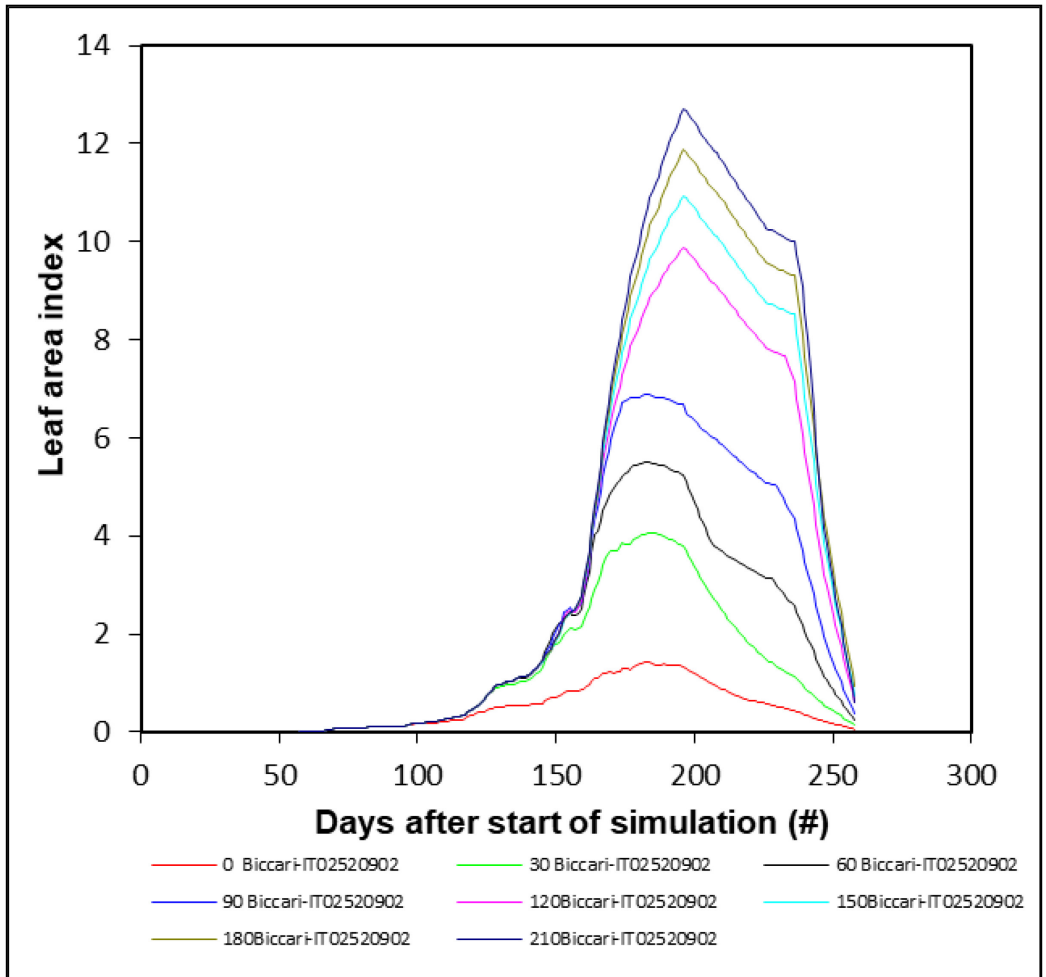

---

# Annexes

---

## Annexes

Ane. 1- Biccari: 2007-2008 Tops weight

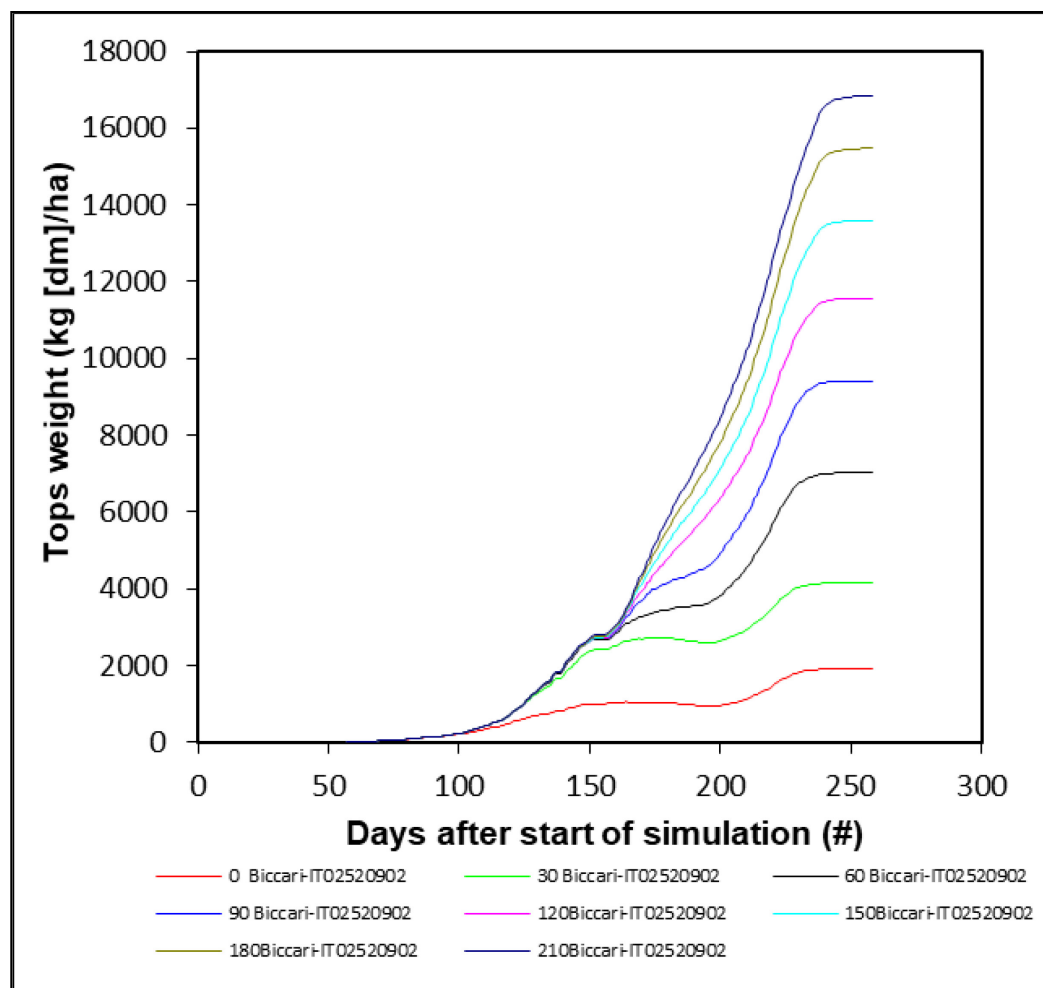

---

# Annexes

---

## Annexes

### Ane. 2- Biccari: 2007-2008 LAI

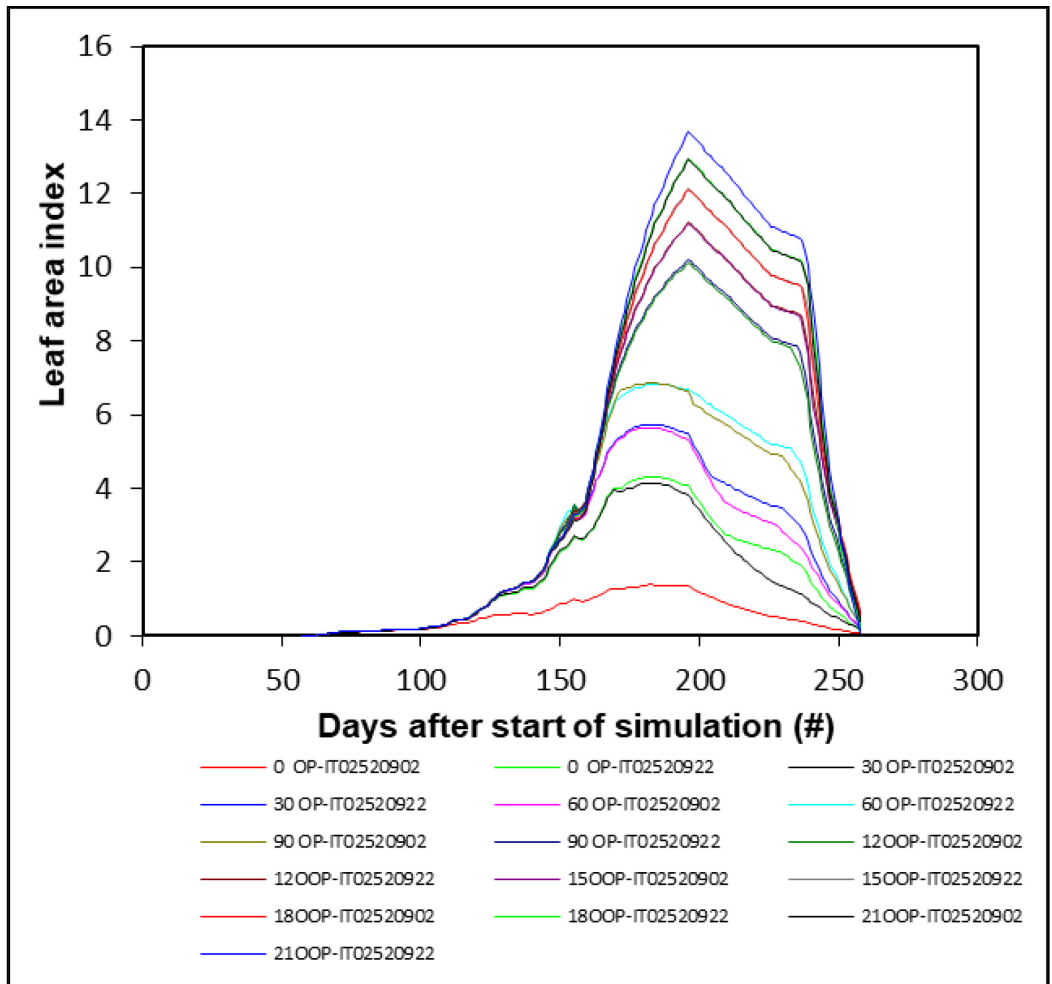

### Ane. 3- Orsara di Puglia: 2007-2008 Tops weight

---

# Annexes

---

Annexes

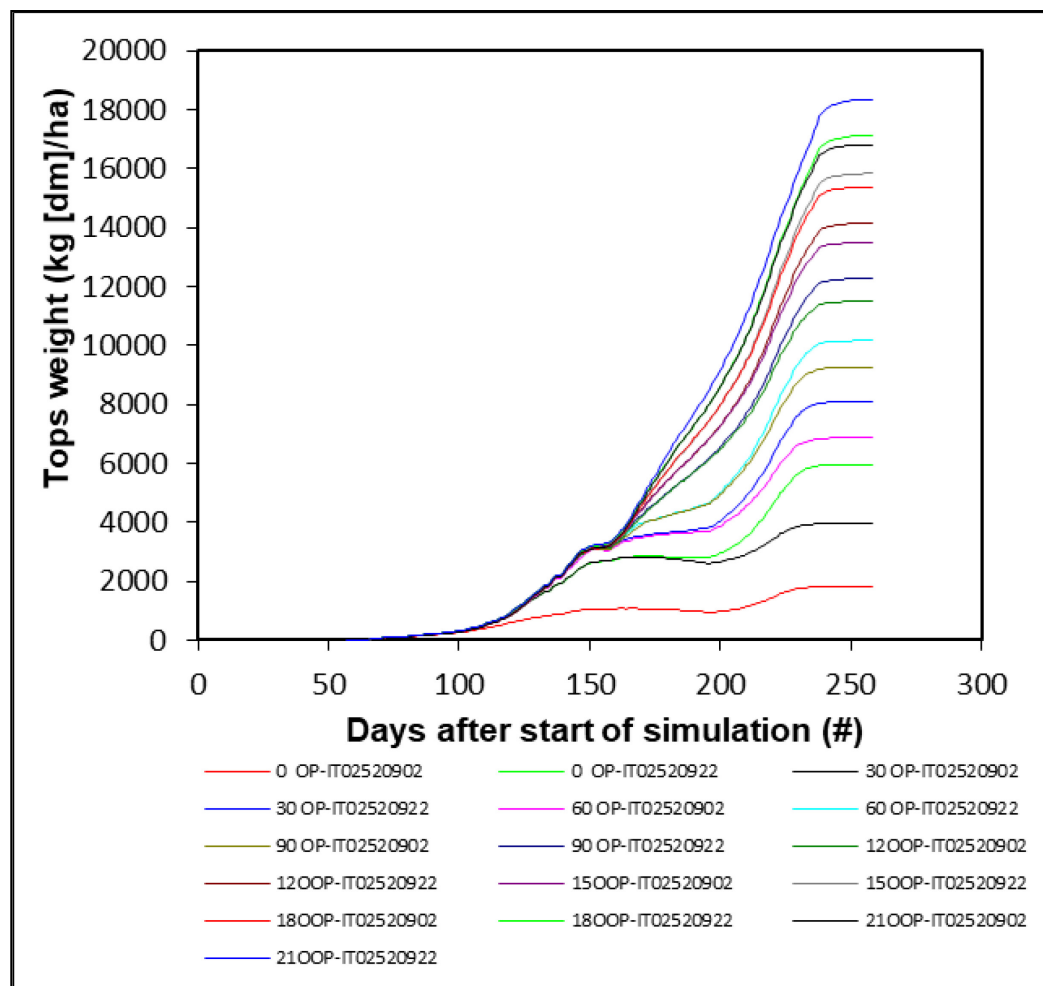

Ane. 4- Orsara di Puglia: 2007-2008 LAI

---

# Annexes

---

## Annexes

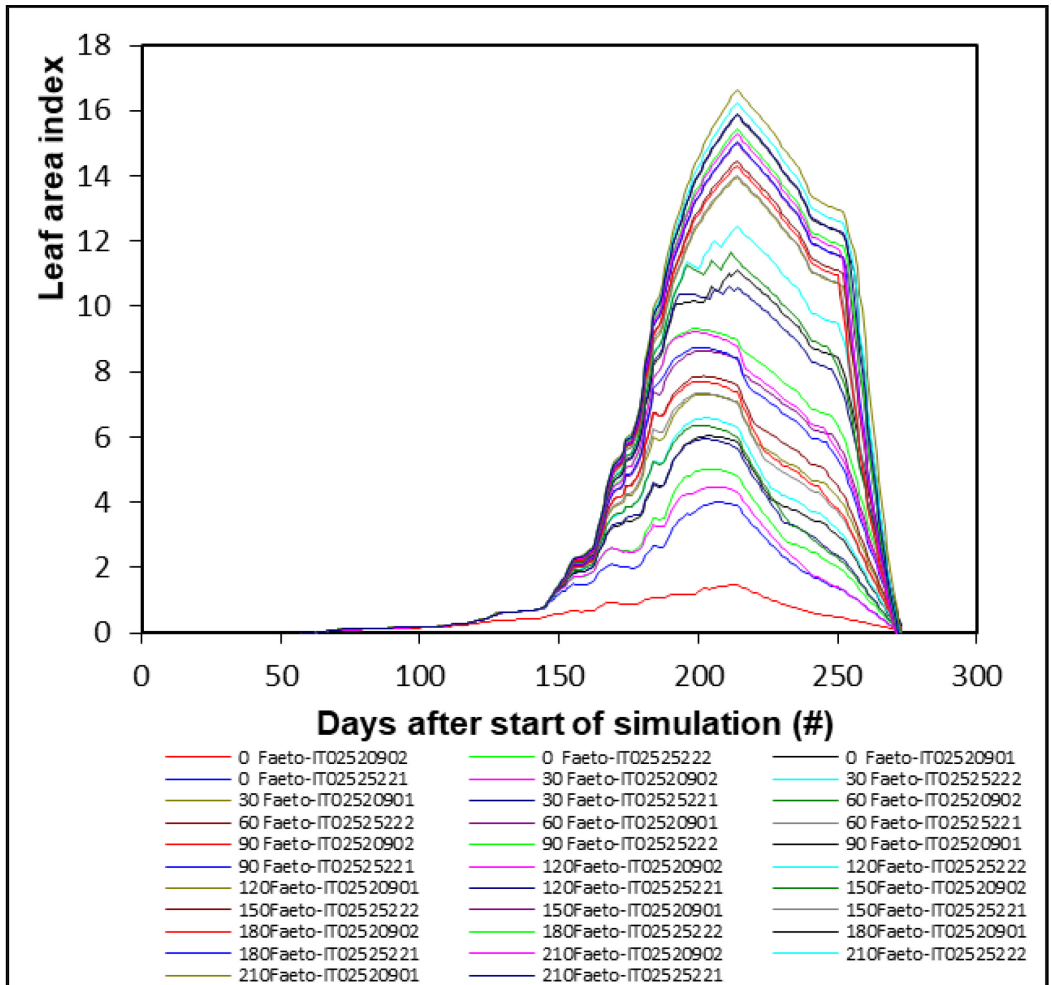

Ane. 5- Faeto: 2007-2008 Tops weight

---

# Annexes

---

Annexes

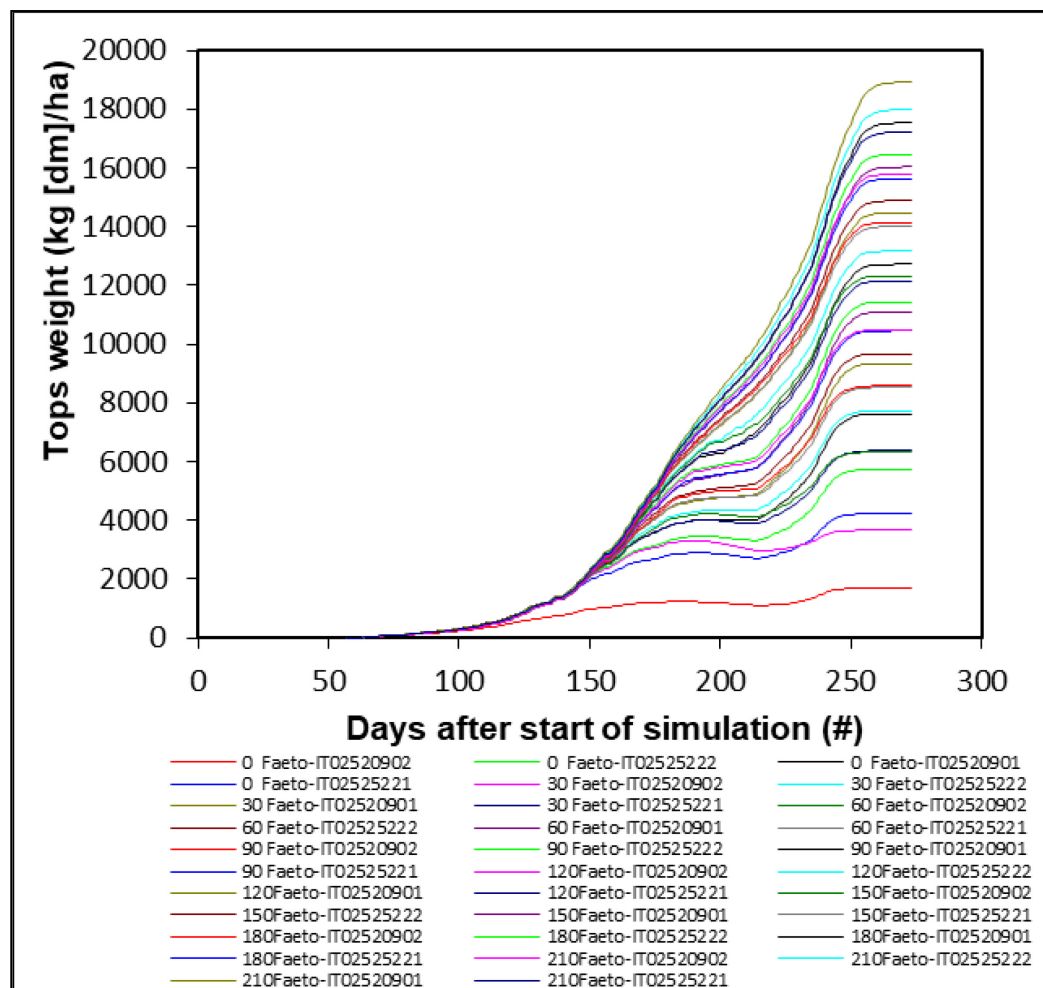

Ane. 6- Faeto: 2007-2008 LAI

---

# Annexes

---

Annexes

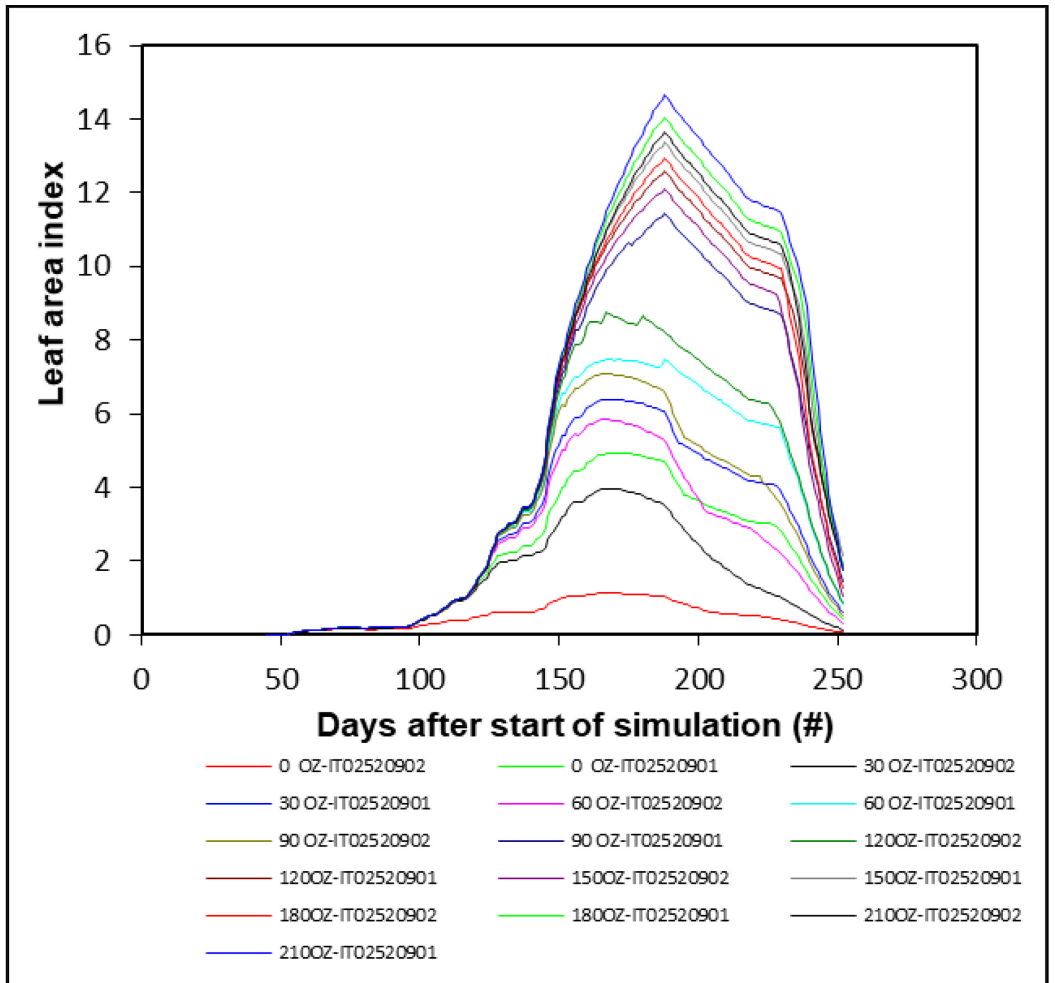

Ane. 7- Orto di Zolfo: 2007-2008 Tops weight

---

# Annexes

---

Annexes

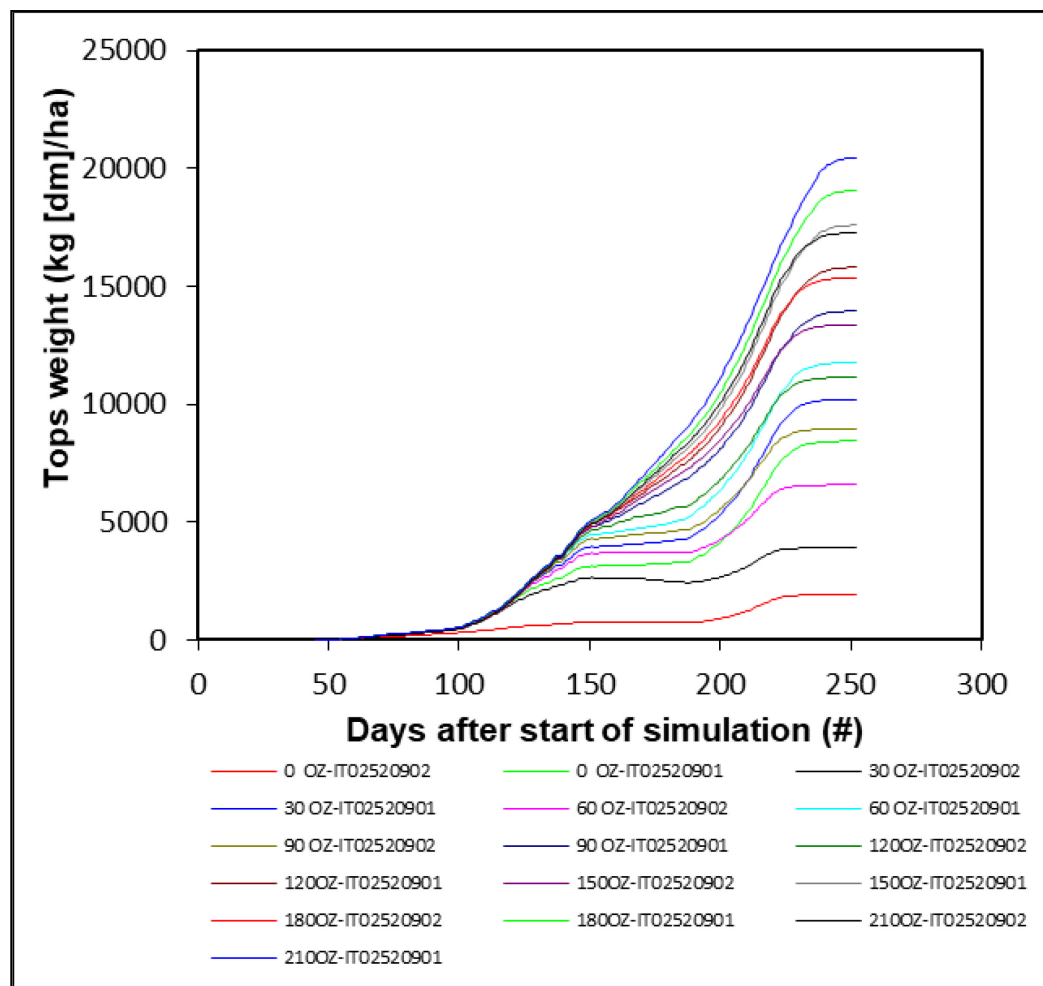

Ane. 8- Orto di Zolfo: 2007-2008 LAI

---

# Annexes

---

Annexes

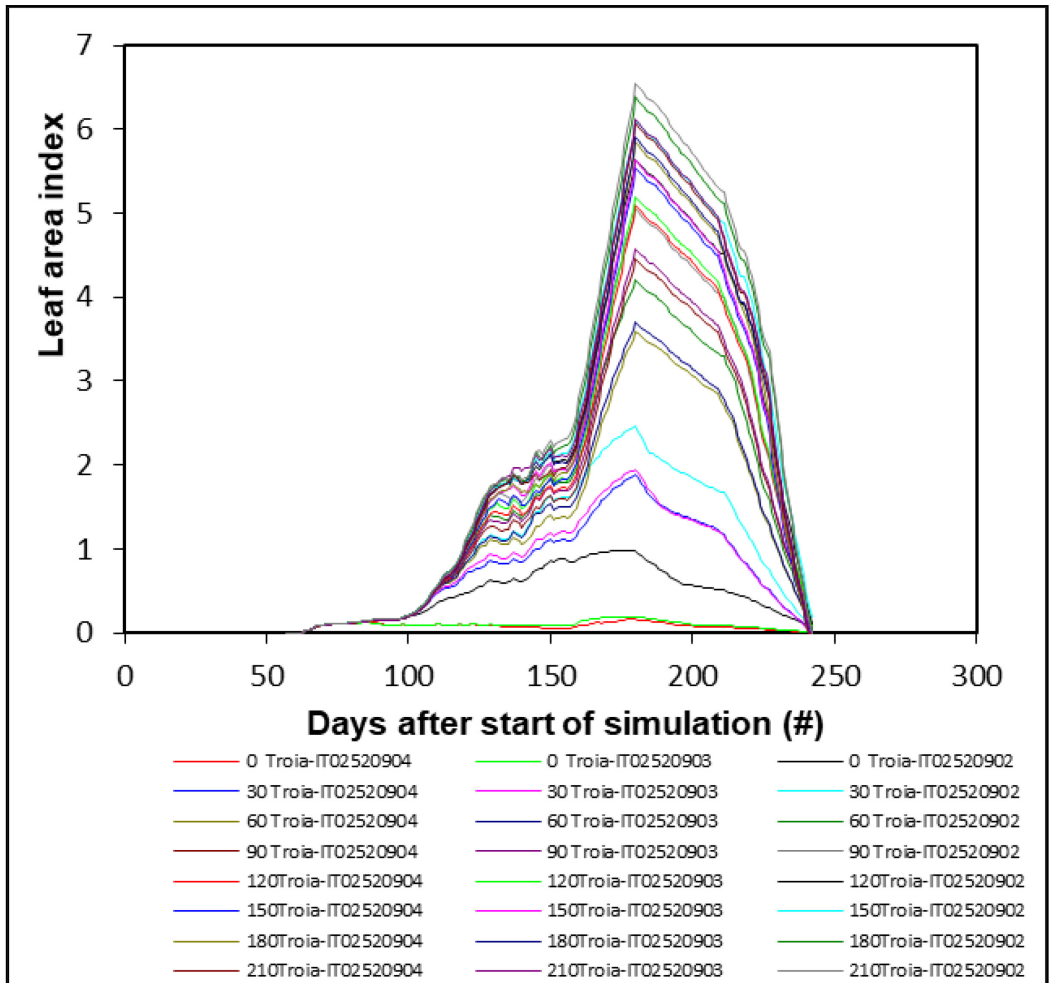

Ane. 9- Troia: 2007-2008 Tops weight

---

# Annexes

---

Annexes

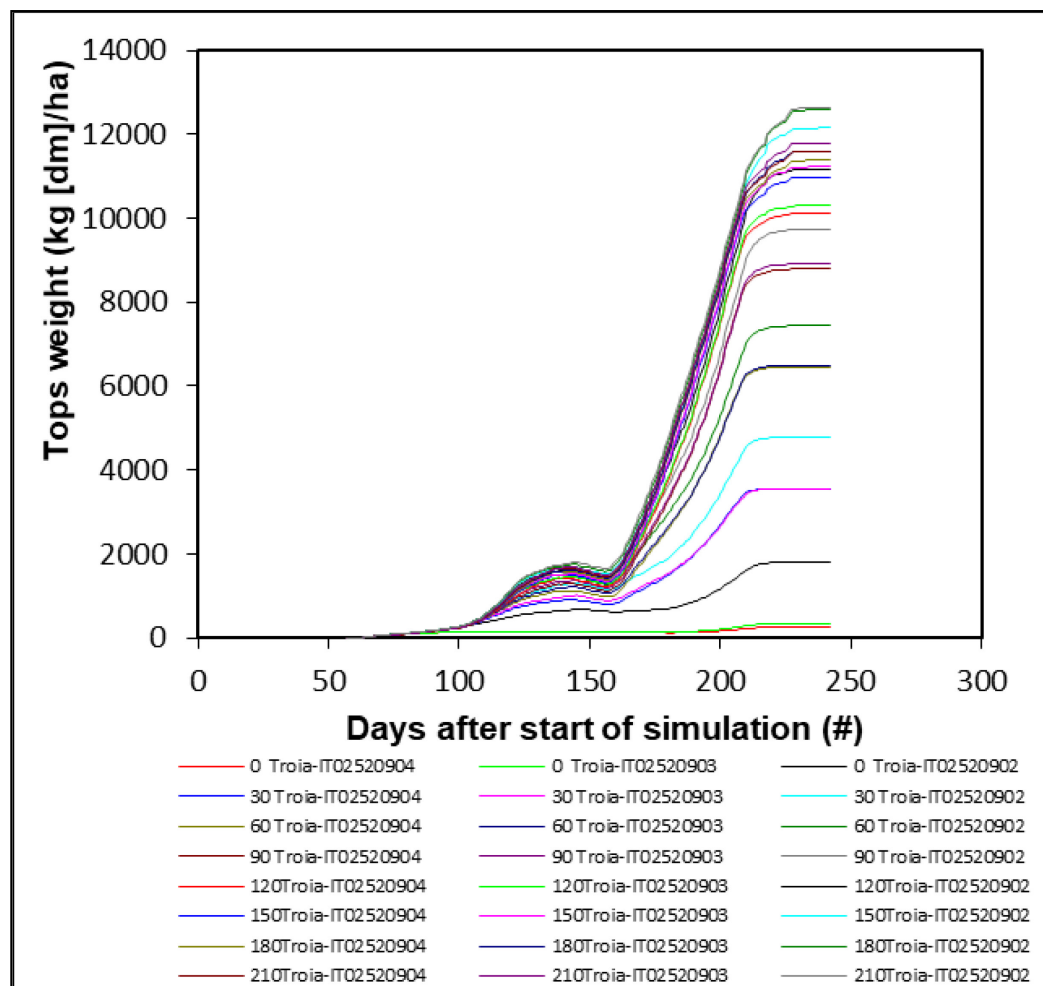

Ane. 10- Troia: 2007-2008 LAI

---

## *References*

---

---

# References

---

## References

### References

- ADAM, M., WERY, J., LEFFELAAR, P. A., EWERT, F., CORBEELS, M. & VAN KEULEN, H. 2013. A systematic approach for re-assembly of crop models: An example to simulate pea growth from wheat growth. *Ecological Modelling*, 250, 258-268.
- ADLER, R. M. 1995. Distributed Coordination Models for Client-Server Computing. *Computer*, 28, 14-22.
- AGGARWAL, P. K., KALRA, N., CHANDER, S. & PATHAK, H. 2006. InfoCrop: A dynamic simulation model for the assessment of crop yields, losses due to pests, and environmental impact of agro-ecosystems in tropical environments. I. Model description. *Agricultural Systems*, 89, 1-25.
- AHMED, M., AKRAM, M. N., ASIM, M., ASLAM, M., HASSAN, F. U., HIGGINS, S., STOCKLE, C. O. & HOOGENBOOM, G. 2016. Calibration and validation of APSIM-Wheat and CERES-Wheat for spring wheat under rainfed conditions: Models evaluation and application. *Computers and Electronics in Agriculture*, 123, 384-401.
- AHMED, M. & HASSAN, F. 2011. *APSIM and DSSAT models as decision support tools*.
- AHUJA, L. R., ROJAS, K. W., HANSON, J. D., SHAFFER, M. J. & MA, L. 2000. *The Root Zone Water Quality Model*, Highlands Ranch, CO, Water Resources Publication.
- ALEXANDROV, V. 1997. *A decision support system for agro-technology transfer (DSSAT) as an approach for irrigation planning and management of maize crop in Bulgaria*.
- ANDALES, A. A., BATCHELOR, W. D., ANDERSON, C. E., FARNHAM, D. E. & WHIGHAM, D. K. 2000. Incorporating tillage effects into a soybean model. *Agricultural Systems*, 66, 69-98.
- ANDREADIS, K. M., DAS, N., STAMPOULIS, D., INES, A., FISHER, J. B., GRANGER, S., KAWATA, J., HAN, E. & BEHRANGI, A. 2017. The Regional Hydrologic

---

# References

---

## References

- Extremes Assessment System: A software framework for hydrologic modeling and data assimilation. *PLoS One*, 12, e0176506.
- ANOTHAI, J., PATANOTHAI, A., JOGLOY, S., PANNANGPETCH, K., BOOTE, K. J. & HOOGENBOOM, G. 2008. A sequential approach for determining the cultivar coefficients of peanut lines using end-of-season data of crop performance trials. *Field Crops Research*, 108, 169-178.
- ANOTHAI, J., SOLER, C. M. T., GREEN, A., TROUT, T. J. & HOOGENBOOM, G. 2013. Evaluation of two evapotranspiration approaches simulated with the CSM-CERES-Maize model under different irrigation strategies and the impact on maize growth, development and soil moisture content for semi-arid conditions. *Agricultural and Forest Meteorology*, 176, 64-76.
- ANTONELLI, M., SICILIANO, G., TURVANI, M. E. & RULLI, M. C. 2015. Global investments in agricultural land and the role of the EU: Drivers, scope and potential impacts. *Land Use Policy*, 47, 98-111.
- AQUAVEO. 2017. *Introduction / Aquaveo.com* [Online]. Available: <https://www.aquaveo.com/> [Accessed].
- ARAKAWA, T., YOSHIMURA, H., SAITO, F. & OGOCHI, K. 2011. *Data exchange algorithm and software design of KAKUSHIN coupler Jcup*.
- ARAYA, A., HOOGENBOOM, G., LUEDELING, E., HADGU, K. M., KISEKKA, I. & MARTORANO, L. G. 2015. Assessment of maize growth and yield using crop models under present and future climate in southwestern Ethiopia. *Agricultural and Forest Meteorology*, 214, 252-265.
- ARAYA, A., KISEKKA, I., GOWDA, P. H. & PRASAD, P. V. V. 2017. Evaluation of water-limited cropping systems in a semi-arid climate using DSSAT-CSM. *Agricultural Systems*, 150, 86-98.
- ARGENT, R. M. 2004. An overview of model integration for environmental application - components, frameworks and semantics. *Environmental Modelling & Software*, 19, 219-234.

---

# References

---

## References

- ARGENT, R. M., PERRAUD, J. M., RAHMAN, J. M., GRAYSON, R. B. & PODGER, G. M. 2009. A new approach to water quality modelling and environmental decision support systems. *Environmental Modelling & Software*, 24, 809-818.
- ARKIN, A., ASKARY, S., BLOCH, B., CURBERA, F., GOLAND, Y., KARTHA, N., LIU, C. K., THATTE, S., YENDLURI, P. & YIU, A. 2005. Web services business process execution language version 2.0. *Working Draft. WS-BPEL TC OASIS*.
- ARMSTRONG, C. W., FORD, R. W. & RILEY, G. D. 2009. Coupling integrated Earth System Model components with BFG2. *Concurrency and Computation-Practice & Experience*, 21, 767-791.
- ARMSTRONG, R., KUMFERT, G., MCINNES, L. C., PARKER, S., ALLAN, B., SOTTILE, M., EPPERLY, T. & DAHLGREN, T. 2006. The CCA component model for high-performance scientific computing. *Concurrency and Computation-Practice & Experience*, 18, 215-229.
- ARORA, R. 1982. Validation of an SOR model for situation, enduring, and response components of involvement. *Journal of Marketing Research*, 505-516.
- ARTHUR, R. F., GURLEY, E. S., SALJE, H., BLOOMFIELD, L. S. P. & JONES, J. H. 2017. Contact structure, mobility, environmental impact and behaviour: the importance of social forces to infectious disease dynamics and disease ecology. *Philosophical Transactions of the Royal Society B-Biological Sciences*, 372.
- ASADI, M. & CLEMENTE, R. 2003. *Evaluation of CERES-Maize of DSSAT model to simulate nitrate leaching, yield and soil moisture content under tropical conditions*, researchgate.net.
- ASSENG, S., BAR-TAL, A., BOWDEN, J. W., KEATING, B. A., VAN HERWAARDEN, A., PALTA, J. A., HUTH, N. I. & PROBERT, M. E. 2002. Simulation of grain protein content with APSIM-Nwheat. *European Journal of Agronomy*, 16, 25-42.
- ATTIA, A., RAJAN, N., XUE, Q. W., NAIR, S., IBRAHIM, A. & HAYS, D. 2016. Application of DSSAT-CERES-Wheat model to simulate winter wheat response to irrigation

---

# References

---

## References

- management in the Texas High Plains. *Agricultural Water Management*, 165, 50-60.
- AVERYT, K., MELDRUM, J., CALDWELL, P., SUN, G., MCNULTY, S., HUBER-LEE, A. & MADDEN, N. 2013. Sectoral contributions to surface water stress in the coterminous United States. *Environmental Research Letters*, 8, 035046.
- BABENDREIER, J. E. & CASTLETON, K. J. 2005. Investigating uncertainty and sensitivity in integrated, multimedia environmental models: tools for FRAMES-3MRA. *Environmental Modelling & Software*, 20, 1043-1055.
- BADR, G., KLEIN, L. J., FREITAG, M., ALBRECHT, C. M., MARIANNO, F. J., LU, S., SHAO, X., HINDS, N., HOOGENBOOM, G. & HAMANN, H. F. 2016. Toward large-scale crop production forecasts for global food security. *Ibm Journal of Research and Development*, 60.
- BAGSTAD, K., VILLA, F., JOHNSON, G. & VOIGT, B. 2011. ARIES—Artificial Intelligence for Ecosystem Services: a guide to models and data, version 1.0. *ARIES report series*, 1.
- BALACCO, G., FIGORITO, B., TARANTINO, E., GIOIA, A. & IACOBELLIS, V. 2015. Space–time LAI variability in Northern Puglia (Italy) from SPOT VGT data. *Environmental Monitoring and Assessment*, 187, 434.
- BALAJI, V. 2012. The Flexible Modeling System. *Earth System Modelling - Volume 3*. Springer.
- BALAY, S., ABHYANKAR, S., ADAMS, M., BRUNE, P., BUSCHELMAN, K., DALCIN, L., GROPP, W., SMITH, B., KARPEYEV, D. & KAUSHIK, D. 2016. Petsc users manual revision 3.7. Argonne National Lab.(ANL), Argonne, IL (United States).
- BALENZANO, A., SATALINO, G., LOVERGINE, F., RINALDI, M., IACOBELLIS, V., MASTRONARDI, N. & MATTIA, F. 2013. On the use of temporal series of L-and X-band SAR data for soil moisture retrieval. Capitanata plain case study. *European Journal of Remote Sensing*, 46, 721-737.
- BALENZANO A., G. S., A. BELMONTE, G. D'URSO, F. CAPODICI, V. IACOBELLIS, A. GIOIA, M. RINALDI, S. RUGGIERI AND F. MATTIA 2011. On the use of multi-

---

# References

---

## References

- temporal series of Cosmo-SkyMed data for landcover classification and surface parameter retrieval over agricultural sites. *IEEE International Geoscience and Remote Sensing Symposium*, 29-24.
- BANNAYAN, M., CROUT, N. M. J. & HOOGENBOOM, G. 2003. Application of the CERES-Wheat model for within-season prediction of winter wheat yield in the United Kingdom. *Agronomy Journal*, 95, 114-125.
- BANNAYAN, M. & HOOGENBOOM, G. 2009. Using pattern recognition for estimating cultivar coefficients of a crop simulation model. *Field Crops Research*, 111, 290-302.
- BAO, Y. W., HOOGENBOOM, G., MCCLENDON, R. & VELLIDIS, G. 2017. A comparison of the performance of the CSM-CERES-Maize and EPIC models using maize variety trial data. *Agricultural Systems*, 150, 109-119.
- BARGA, R., JACKSON, J., ARAUJO, N., GUO, D., GAUTAM, N. & SIMMHAN, Y. 2008. *The Trident Scientific Workflow Workbench*.
- BARR, A. G., KITE, G. W., GRANGER, R. & SMITH, C. 1997. Evaluating three evapotranspiration methods in the slurrp macroscale hydrological model. *Hydrological Processes*, 11, 1685-1705.
- BAVOIL, L., P. CALLAHAN, S., SCHEIDEGGER, C., T. VO, H., CROSSNO, P., SILVA, C. & FREIRE, J. 2005. *VisTrails: Enabling Interactive Multiple-View Visualizations*.
- BEHR, P., FOOS, D. & NORDEN, L. 2017. Cyclicity of SME lending and government involvement in banks. *Journal of Banking & Finance*, 77, 64-77.
- BEINROTH, F., JONES, J., KNAPP, E., PAPAJORJGI, P. & ... 1997. *Application of DSSAT to the evaluation of land resources. Chapter 14 in Tsuji GY, Hoogenboom G, Thornton PK (eds.) International Benchmark Sites ...*, Kluwer Academic Publishers.
- BERGEZ, J. E., RAYNAL, H., LAUNAY, M., BEAUDOIN, N., CASELLAS, E., CAUBEL, J., CHABRIER, P., COUCHENEY, E., DURY, J., DE CORTAZAR-ATAURI, I. G., JUSTES, E., MARY, B., RIPOCHE, D. & RUGET, F. 2014. Evolution of the STICS crop model to tackle new environmental issues: New formalisms and

---

# References

---

## References

- integration in the modelling and simulation platform RECORD. *Environmental Modelling & Software*, 62, 370-384.
- BEST, M. J., PRYOR, M., CLARK, D. B., ROONEY, G. G., ESSERY, R. L. H., MÉNARD, C. B., EDWARDS, J. M., HENDRY, M. A., PORSON, A., GEDNEY, N., MERCADO, L. M., SITCH, S., BLYTH, E., BOUCHER, O., COX, P. M., GRIMMOND, C. S. B. & HARDING, R. J. 2011. The Joint UK Land Environment Simulator (JULES), model description – Part 1: Energy and water fluxes. *Geosci. Model Dev.*, 4, 677-699.
- BETTS, R. A. 2005. Integrated approaches to climate-crop modelling: needs and challenges. *Philos Trans R Soc Lond B Biol Sci*, 360, 2049-2065.
- BEYER, H. L. 2017. *Geospatial Modelling Environment (GME)* [Online]. Available: <http://www.spatial ecology.com/gme/> [Accessed April 19 2017].
- BIONDI, D., FRENI, G., IACOBELLIS, V., MASCARO, G. & MONTANARI, A. 2012. Validation of hydrological models: Conceptual basis, methodological approaches and a proposal for a code of practice. *Physics and Chemistry of the Earth, Parts A/B/C*, 42-44, 70-76.
- BOEGH, E., THORSEN, M., BUTTS, M. B., HANSEN, S., CHRISTIANSEN, J. S., ABRAHAMSEN, P., HASAGER, C. B., JENSEN, N. O., VAN DER KEUR, P., REFSGAARD, J. C., SCHELDE, K., SOEGAARD, H. & THOMSEN, A. 2004a. Incorporating remote sensing data in physically based distributed agro-hydrological modelling. *Journal of Hydrology*, 287, 279-299.
- BOEGH, E., THORSEN, M., BUTTS, M. B., HANSEN, S., CHRISTIANSEN, J. S., ABRAHAMSEN, P., HASAGER, C. B., JENSEN, N. O., VAN DER KEUR, P., REFSGAARD, J. C., SCHELDE, K., SOEGAARD, H. & THOMSEN, A. 2004b. Incorporating remote sensing data in physically based distributed agro-hydrological modelling. *Journal of Hydrology*, 287, 279-299.
- BOLTE, J. P., HULSE, D. W., GREGORY, S. V. & SMITH, C. 2007. Modeling biocomplexity—actors, landscapes and alternative futures. *Environmental Modelling & Software*, 22, 570-579.

---

# References

---

## References

- BOONE, M. Y. L., PORTER, D. O. & MCKINION, J. M. 1993. Calibration of GOSSYM: Theory and practice. *Computers and Electronics in Agriculture*, 9, 193-203.
- BORMANN, H. 2006. Impact of spatial data resolution on simulated catchment water balances and model performance of the multi-scale TOPLATS model. *Hydrology and Earth System Sciences*, 10, 165-179.
- BORMANN, H., BREUER, L., GRÄFF, T. & HUISMAN, J. A. 2007. Analysing the effects of soil properties changes associated with land use changes on the simulated water balance: A comparison of three hydrological catchment models for scenario analysis. *Ecological Modelling*, 209, 29-40.
- BORMANN, H., BREUER, L., GRÄFF, T., HUISMAN, J. A. & CROKE, B. 2009. Assessing the impact of land use change on hydrology by ensemble modelling (LUCHEM) IV: Model sensitivity to data aggregation and spatial (re-)distribution. *Advances in Water Resources*, 32, 171-192.
- BOYLAN, J. W. & RUSSELL, A. G. 2006. PM and light extinction model performance metrics, goals, and criteria for three-dimensional air quality models. *Atmospheric Environment*, 40, 4946-4959.
- BRANDMEYER, J. E. & KARIMI, H. A. 2000. Coupling methodologies for environmental models. *Environmental Modelling & Software*, 15, 479-488.
- BREUER, L., HUISMAN, J. A., WILLEMS, P., BORMANN, H., BRONSTERT, A., CROKE, B. F. W., FREDE, H.-G., GRÄFF, T., HUBRECHTS, L., JAKEMAN, A. J., KITE, G., LANINI, J., LEAVESLEY, G., LETTENMAIER, D. P., LINDSTRÖM, G., SEIBERT, J., SIVAPALAN, M. & VINEY, N. R. 2009. Assessing the impact of land use change on hydrology by ensemble modeling (LUCHEM). I: Model intercomparison with current land use. *Advances in Water Resources*, 32, 129-146.
- BRISSON, N., MARY, B., RIPOCHE, D., JEUFFROY, M. H., RUGET, F., NICOULLAUD, B., GATE, P., DEVIENNE-BARRET, F., ANTONIOLETTI, R., DURR, C., RICHARD, G., BEAUDOIN, N., RECOUS, S., TAYOT, X., PLENET, D., CELLIER, P., MACHET, J.-M., MEYNARD, J. M. & DELÉCOLLE, R. 1998. STICS: a generic

---

# References

---

## References

- model for the simulation of crops and their water and nitrogen balances. I. Theory and parameterization applied to wheat and corn. *Agronomie*, 18, 311-346.
- BUEHLER, K. & MCKEE, L. 1996. *The OpenGIS Guide: Introduction to Interoperable Geoprocessing: Part I of the Open Geodata Interoperability Specification (OGIS)*, Open GIS Consortium, Incorporated.
- BUTLER, S., WEBSTER, T., REDDEN, A., RAND, J., CROWELL, N. & LIVINGSTONE, W. 2014. Using Remote Sensing to Identify Changes in Land Use and Sources of Fecal Bacteria to Support a Watershed Transport Model. *Water*, 6, 1925-1944.
- CAMPBELL, C. A. & PAUL, E. A. 1978. Effects of Fertilizer N and Soil Moisture on Mineralization, N Recovery and a-Values, under Spring Wheat Grown in Small Lysimeters. *Canadian Journal of Soil Science*, 58, 39-51.
- CARADOC-DAVIES, B. 2017. *Spatial Information Services Stack* [Online]. Available: <https://www.seegrid.csiro.au/wiki/Siss/WebHome> [Accessed].
- CARBERRY, P., HUTH, N., POULTON, P. & ... 2002. *Quantifying the tradeoff between tree and crop productivity on farms*, rirdc.infoservices.com.au.
- CASTRONOVA, A. M., GOODALL, J. L. & ERCAN, M. B. 2013. Integrated modeling within a Hydrologic Information System: An OpenMI based approach. *Environmental Modelling & Software*, 39, 263-273.
- CCMP. 2017. *Chesapeake Community Modeling Program* [Online]. Available: <http://ches.communitymodeling.org/index.php> [Accessed].
- CHANG, M. 2012. *Forest hydrology: an introduction to water and forests*, CRC press.
- CHEN, W., SHEN, Y. Y., ROBERTSON, M. J., PROBERT, M. E. & BELLOTTI, W. D. 2008. Simulation analysis of lucerne-wheat crop rotation on the Loess Plateau of Northern China. *Field Crops Research*, 108, 179-187.
- COHEN-BOULAKIA, S., CHEN, J. Q., MISSIER, P., GOBLE, C., WILLIAMS, A. R. & FROIDEVAUX, C. 2014. Distilling structure in Taverna scientific workflows: a refactoring approach. *Bmc Bioinformatics*, 15.

---

# References

---

## References

- COLEMAN, S., GOB, R., MANCO, G., PIEVATOLO, A., TORT-MARTORELL, X. & REIS, M. S. 2016. How Can SMEs Benefit from Big Data? Challenges and a Path Forward. *Quality and Reliability Engineering International*, 32, 2151-2164.
- CORBEELS, M., CHIRAT, G., MESSAD, S. & THIERFELDER, C. 2016. Performance and sensitivity of the DSSAT crop growth model in simulating maize yield under conservation agriculture. *European Journal of Agronomy*, 76, 41-53.
- CRAIG, A. P., JACOB, R., KAUFFMAN, B., BETTGE, T., LARSON, J., ONG, E., DINGO, C. & HE, Y. 2005. Cpl6: The new extensible, high performance parallel coupler for the Community Climate System Model. *International Journal of High Performance Computing Applications*, 19, 309-327.
- CROKE, B. F., ANDREWS, F., JAKEMAN, A., CUDDY, S. & LUDDY, A. Redesign of the IHACRES rainfall-runoff model. 29th Hydrology and Water Resources Symposium: Water Capital, 20-23 February 2005, Rydges Lakeside, Canberra, 2005. Engineers Australia, 333.
- CUDDY, S. & FITCH, P. 2010. *Hydrologists Workbench—a hydrological domain workflow toolkit*. International Environmental Modelling and Software Society.
- D'AMORE, L., CASABURI, D., GALLETI, A., MARCELLINO, L. & MURLI, A. 2011. Integration of emerging computer technologies for an efficient image sequences analysis. *Integrated Computer-Aided Engineering*, 18, 365-378.
- DAHMAN, J. S., KUHL, F. & WEATHERLY, R. 2016. Standards for Simulation: As Simple As Possible But Not Simpler The High Level Architecture For Simulation. *Simulation*, 71, 378-387.
- DAVID, O., ASCOUGH, J. C., LLOYD, W., GREEN, T. R., ROJAS, K. W., LEAVESLEY, G. H. & AHUJA, L. R. 2013. A software engineering perspective on environmental modeling framework design: The Object Modeling System. *Environmental Modelling & Software*, 39, 201-213.
- DAVID, O., MARKSTROM, S. L., ROJAS, K. W., AHUJA, L. R. & SCHNEIDER, I. W. 2002. The object modeling system. *Agricultural system models in field research and technology transfer*. CRC Press.

---

# References

---

## References

- DE NOBLET-DUCOUDRÉ, N., GERVOIS, S., CIAIS, P., VIOVY, N., BRISSON, N., SEGUIN, B. & PERRIER, A. 2004. Coupling the soil-vegetation-atmosphere-transfer scheme ORCHIDEE to the agronomy model STICS to study the influence of croplands on the European carbon and water budgets. *Agronomie*, 24, 397-407.
- DEELMAN, E., SINGH, G., SU, M.-H., BLYTHE, J., GIL, Y., KESSELMAN, C., MEHTA, G., VAHI, K., BERRIMAN, G. B. & GOOD, J. 2005. Pegasus: A framework for mapping complex scientific workflows onto distributed systems. *Scientific Programming*, 13, 219-237.
- DEFRIES, R. & ESHLEMAN, K. N. 2004. Land-use change and hydrologic processes: a major focus for the future. *Hydrological Processes*, 18, 2183-2186.
- DENNIS, J. M., VERTENSTEIN, M., WORLEY, P. H., MIRIN, A. A., CRAIG, A. P., JACOB, R. & MICKELSON, S. 2012. Computational performance of ultra-high-resolution capability in the Community Earth System Model. *International Journal of High Performance Computing Applications*, 26, 5-16.
- DERYNG, D., SACKS, W. J., BARFORD, C. C. & RAMANKUTTY, N. 2011. Simulating the effects of climate and agricultural management practices on global crop yield. *Global Biogeochemical Cycles*, 25, n/a-n/a.
- DI MODUGNO, M., GIOIA, A., GORGOGLIONE, A., IACOBELLIS, V., LA FORGIA, G., PICCINNI, A. & RANIERI, E. 2015. Build-Up/Wash-Off Monitoring and Assessment for Sustainable Management of First Flush in an Urban Area. *Sustainability*, 7, 5050.
- DIACONO, M., CASTRIGNAN, A., TROCCOLI, A., DE BENEDETTO, D., BASSO, B. & RUBINO, P. 2012. Spatial and temporal variability of wheat grain yield and quality in a Mediterranean environment: A multivariate geostatistical approach. *Field Crops Research*, 131, 49-62.
- DIEPEN, C. V., WOLF, J., KEULEN, H. V. & RAPPOLDT, C. 1989. WOFOST: a simulation model of crop production. *Soil use and management*, 5, 16-24.

---

# References

---

## References

- DISNEY, M., MULLER, J. P., KHARBOUCHE, S., KAMINSKI, T., VOSSBECK, M., LEWIS, P. & PINTY, B. 2016. A New Global fAPAR and LAI Dataset Derived from Optimal Albedo Estimates: Comparison with MODIS Products. *Remote Sensing*, 8.
- DOKOOHAKI, H., GHEYSARI, M., MEHNATKESH, A. & AYOUBI, S. 2015. Applying the CSM-CERES-Wheat model for rainfed wheat with specified soil characteristic in undulating area in Iran. *Archives of Agronomy and Soil Science*, 61, 1231-1245.
- DOKOOHAKI, H., GHEYSARI, M., MOUSAVI, S.-F., ZAND-PARSA, S., MIGUEZ, F. E., ARCHONTOULIS, S. V. & HOOGENBOOM, G. 2016a. Coupling and testing a new soil water module in DSSAT CERES-Maize model for maize production under semi-arid condition. *Agricultural Water Management*, 163, 90-99.
- DOKOOHAKI, H., GHEYSARI, M., MOUSAVI, S. F., ZAND-PARSA, S., MIGUEZ, F. E., ARCHONTOULIS, S. V. & HOOGENBOOM, G. 2016b. Coupling and testing a new soil water module in DSSAT CERES-Maize model for maize production under semi-arid condition. *Agricultural Water Management*, 163, 90-99.
- DONCHYTS, G. & JAGERS, B. 2010. *DeltaShell-an open modelling environment*.
- DREWNIAK, B., SONG, J., PRELL, J., KOTAMARTHI, V. R. & JACOB, R. 2013. Modeling agriculture in the Community Land Model. *Geoscientific Model Development*, 6, 495-515.
- DRIESSEN, P. M. & KONIJN, N. T. 1992. *Land-use systems analysis*, WAU and Interdisciplinary Research (INRES).
- DRUMMOND, L., DEMMEL, J., MECHOSO, C., ROBINSON, H., SKLOWER, K. & SPAHR, J. 2001. A data broker for distributed computing environments. *Computational Science—ICCS 2001*, 31-40.
- DUFAUD, T. & TROMEUR-DERVOUIT, D. 2013. Reprint of Efficient parallel implementation of the fully algebraic multiplicative Aitken-RAS preconditioning technique. *Advances in Engineering Software*, 60-61, 2-13.

---

# References

---

## References

- DUNLAP, R., RUGABER, S. & MARK, L. 2013. A feature model of coupling technologies for Earth System Models. *Computers & Geosciences*, 53, 13-20.
- DZOTSI, K. A., JONES, J. W., ADIKU, S. G. K., NAAB, J. B., SINGH, U., PORTER, C. H. & GIJSMAN, A. J. 2010. Modeling soil and plant phosphorus within DSSAT. *Ecological Modelling*, 221, 2839-2849.
- ESA/AOES-MEDIALAB 2004a. Terrestrial and atmospheric components of the water cycle. *In: TERRESTRIAL\_AND\_ATMOSPHERIC\_COMPONENTS\_OF\_THE\_WATER\_CYCLE.JPG* (ed.) *SMOS*. ESA.
- ESA/AOES-MEDIALAB 2004b. The water cycle. *In: THE\_WATER\_CYCLE.JPG* (ed.) *SMOS*. ESA.
- ETKIN, D., KIRSHEN, P., WATKINS, D., DIALLO, A. A., HOOGENBOOM, G., RONCOLI, M. C., SANFO, J., SANON, M., SOMÉ, L. & ZOUNGRANA, J. Stochastic linear programming for improved reservoir operations for multiple objectives in Burkina Faso, West Africa. World Environmental and Water Resources Congress 2008: Ahupua'A, 2008. 1-9.
- EVANS, K. J., SALINGER, A. G., WORLEY, P. H., PRICE, S. F., LIPSCOMB, W. H., NICHOLS, J. A., WHITE, J. B., PEREGO, M., VERTENSTEIN, M., EDWARDS, J. & LEMIEUX, J. F. 2012. A modern solver interface to manage solution algorithms in the Community Earth System Model. *International Journal of High Performance Computing Applications*, 26, 54-62.
- FALL, A. & FALL, J. 2001. A domain-specific language for models of landscape dynamics. *Ecological Modelling*, 141, 1-18.
- FAMIGLIETTI, J., MURDOCH, L., LAKSHMI, V. & HOOPER, R. 2008. Community Modeling in Hydrologic Science: Scoping Workshop on a Community Hydrologic Modeling Platform (CHyMP); Washington, D.C., 26–27 March 2008. *Eos, Transactions American Geophysical Union*, 89, 292-292.
- FAMIGLIETTI, J. S. & WOOD, E. F. 1994. Multiscale modeling of spatially variable water and energy balance processes. *Water Resources Research*, 30, 3061-3078.

---

# References

---

## References

- FEKETE, B. M., WOLLHEIM, W. M., WISSER, D. & VÖRÖSMARTY, C. J. 2009. Next generation framework for aquatic modeling of the Earth System. *Geoscientific Model Development Discussions*, 2, 279-307.
- FIorentino, M., Gioia, A., Iacobellis, V. & Manfreda, S. 2011. Regional analysis of runoff thresholds behaviour in Southern Italy based on theoretically derived distributions. *Advances in Geosciences*, 26, 139-144.
- FORD, R. W., RILEY, G. D., BANE, M. K., ARMSTRONG, C. W. & FREEMAN, T. L. 2006. GCF: a general coupling framework. *Concurrency and Computation-Practice & Experience*, 18, 163-181.
- FORMETTA, G., CAPPARELLI, G., DAVID, O., GREEN, T. R. & RIGON, R. 2016. Integration of a Three-Dimensional Process-Based Hydrological Model into the Object Modeling System. *Water*, 8.
- FOURNIER, C., ANDRIEU, B., LJUTOVAC, S. & SAINT-JEAN, S. 2003. ADEL-wheat: A 3D architectural model of wheat development. *Plant Growth Modeling and Applications, Proceedings*, 54-63.
- FRY, J., GUBER, A. K., LADONI, M., MUNOZ, J. D. & KRAVCHENKO, A. N. 2017. The effect of up-scaling soil properties and model parameters on predictive accuracy of DSSAT crop simulation model under variable weather conditions. *Geoderma*, 287, 105-115.
- GERKE, H. H., ARNING, M. & STOPPLER-ZIMMER, H. 1999. Modeling long-term compost application effects on nitrate leaching. *Plant and Soil*, 213, 75-92.
- GIANNAKIS, E., BRUGGEMAN, A., DJUMA, H., KOZYRA, J. & HAMMER, J. 2015. Water pricing and irrigation across Europe: opportunities and constraints for adopting irrigation scheduling decision support systems. *Water Science and Technology: Water Supply*, 16, 245-252.
- GIGANTE, V., IACOBELLIS, V., MANFREDA, S., MILELLA, P. & PORTOGHESE, I. 2009. Influences of Leaf Area Index estimations on water balance modeling in a Mediterranean semi-arid basin. *Natural Hazards and Earth System Science*, 9, 979-991.

---

# References

---

## References

- GIJSBERS, P. J. A., MOORE, R. V. & TINDALL, C. I. 2002. HarmonIT: towards OMI, an Open Modelling Interface and Environment to harmonise European developments in water related simulation software. *In*: CLUCKIE, I. D., HAN, D., DAVIS, J. P. & HESLOP, S. (eds.) *Hydroinformatics 2002 Volume Two: Software Tools and Management Systems*. London: IWA Publishing.
- GIJSMAN, A. J., HOOGENBOOM, G., PARTON, W. J. & KERRIDGE, P. C. 2002. Modifying DSSAT crop models for low-input agricultural systems using a soil organic matter-residue module from CENTURY. *Agronomy Journal*, 94, 462-474.
- GIJSMAN, A. J., THORNTON, P. K. & HOOGENBOOM, G. 2007. Using the WISE database to parameterize soil inputs for crop simulation models. *Computers and Electronics in Agriculture*, 56, 85-100.
- GIOIA, A., IACOBELLIS, V., MANFREDA, S. & FIORENTINO, M. 2008. Effects of runoff thresholds on flood frequency distributions. *Hydrology and Earth System Sciences Discussions*, 5, 903-933.
- GIOIA, A., IACOBELLIS, V., MANFREDA, S. & FIORENTINO, M. 2011. Influence of soil parameters on the skewness coefficient of the annual maximum flood peaks. *Hydrology and Earth System Sciences Discussions*, 8, 5559-5604.
- GIOIA, A., IACOBELLIS, V., MANFREDA, S. & FIORENTINO, M. 2012. Influence of infiltration and soil storage capacity on the skewness of the annual maximum flood peaks in a theoretically derived distribution. *Hydrology and Earth System Sciences*, 16, 937-951.
- GIOIA, A., MANFREDA, S., IACOBELLIS, V. & FIORENTINO, M. 2014. Performance of a Theoretical Model for the Description of Water Balance and Runoff Dynamics in Southern Italy. *Journal of Hydrologic Engineering*, 19, 1113-1123.
- GOLDSIM. 2017. *Monte Carlo Simulation Software - GoldSim* [Online]. Available: <https://www.goldsim.com/Home/> [Accessed].
- GORGOGNONE, A., GIOIA, A., IACOBELLIS, V., PICCINNI, A. F. & RANIERI, E. 2016. A Rationale for Pollutograph Evaluation in Ungauged Areas, Using Daily Rainfall

---

# References

---

## References

- Patterns: Case Studies of the Apulian Region in Southern Italy. *Applied and Environmental Soil Science*, 2016, 1-16.
- GOUDRIAAN, J. & VAN LAAR, H. 2012. *Modelling potential crop growth processes: textbook with exercises*, Springer Science & Business Media.
- GROSS, M., WAN, H., RASCH, P. J., CALDWELL, P. M., WILLIAMSON, D. L., KLOCKE, D., JABLONOWSKI, C., THATCHER, D. R., WOOD, N., CULLEN, M., BEARE, B., WILLETT, M., LEMARIÉ, F., BLAYO, E., MALARDEL, S., TERMONIA, P., GASSMANN, A., LAURITZEN, P. H., JOHANSEN, H., ZARZYCKI, C. M., SAKAGUCHI, K. & LEUNG, R. 2016. Recent progress and review of Physics Dynamics Coupling in geophysical models.
- GROSSMAN, R., BAILEY, S., RAMU, A., MALHI, B., HALLSTROM, P., PULLEYN, I. & QIN, X. 1999. The management and mining of multiple predictive models using the predictive modeling markup language. *Information and Software Technology*, 41, 589-595.
- GUAN, K., SULTAN, B., BIASUTTI, M., BARON, C. & LOBELL, D. B. 2017. Assessing climate adaptation options and uncertainties for cereal systems in West Africa. *Agricultural and Forest Meteorology*, 232, 291-305.
- GUILYARDI, E., BUDICH, R. G., BRASSEUR, G. P. & KOMEN, G. 2003. PRISM System Specification Handbook.
- GUPTA, H. V., KLING, H., YILMAZ, K. K. & MARTINEZ, G. F. 2009. Decomposition of the mean squared error and NSE performance criteria: Implications for improving hydrological modelling. *Journal of Hydrology*, 377, 80-91.
- GUTZLER, C., HELMING, K., BALLA, D., DANNOWSKI, R., DEUMLICH, D., GLEMNITZ, M., KNIERIM, A., MIRSCHEL, W., NENDEL, C., PAUL, C., SIEBER, S., STACHOW, U., STARICK, A., WIELAND, R., WURBS, A. & ZANDER, P. 2015. Agricultural land use changes - A scenario-based sustainability impact assessment for Brandenburg, Germany. *Ecological Indicators*, 48, 505-517.

---

# References

---

## References

- HA, J., EIGENRAAM, M., FORBES, G., LEWIS, W. & CHUA, J. 2010. The Environmental Systems Modelling Platform (EnSym) to Assess Effects of Land Use Changes on Groundwater Recharge.
- HAN, M., ZHAO, C., ŠIMŮNEK, J. & FENG, G. 2015. Evaluating the impact of groundwater on cotton growth and root zone water balance using Hydrus-1D coupled with a crop growth model. *Agricultural Water Management*, 160, 64-75.
- HARPHAM, Q., CLEVERLEY, P. & KELLY, D. 2014. The FluidEarth 2 implementation of OpenMI 2.0. *Journal of Hydroinformatics*, 16, 890-906.
- HARTKAMP, A. D., HOOGENBOOM, G. & WHITE, J. W. 2002. Adaptation of the CROPGRO growth model to velvet bean (*Mucuna pruriens*) I. Model development. *Field Crops Research*, 78, 9-25.
- HECKERMAN, D., MEEK, C. & KOLLER, D. 2007. Probabilistic entity-relationship models, PRMs, and plate models. *Introduction to statistical relational learning*, 201-238.
- HILL, C., DELUCA, C., BALAJI, SUAREZ, M. & DA SILVA, A. 2004. The architecture of the earth system modeling framework. *Computing in Science & Engineering*, 6, 18-28.
- HILLYER, C., BOLTE, J., VAN EVERT, F. & LAMAKER, A. 2003. The ModCom modular simulation system. *European Journal of Agronomy*, 18, 333-343.
- HOLZWORTH, D. P., HUTH, N. I., DEVOIL, P. G., ZURCHER, E. J., HERRMANN, N. I., MCLEAN, G., CHENU, K., VAN OOSTEROM, E. J., SNOW, V., MURPHY, C., MOORE, A. D., BROWN, H., WHISH, J. P. M., VERRALL, S., FAINGES, J., BELL, L. W., PEAKE, A. S., POULTON, P. L., HOCHMAN, Z., THORBURN, P. J., GAYDON, D. S., DALGLIESH, N. P., RODRIGUEZ, D., COX, H., CHAPMAN, S., DOHERTY, A., TEIXEIRA, E., SHARP, J., CICHOTA, R., VOGELER, I., LI, F. Y., WANG, E. L., HAMMER, G. L., ROBERTSON, M. J., DIMES, J. P., WHITBREAD, A. M., HUNT, J., VAN REES, H., MCCLELLAND, T., CARBERRY, P. S., HARGREAVES, J. N. G., MACLEOD, N., MCDONALD, C., HARS DORF, J.,

---

# References

---

## References

- WEDGWOOD, S. & KEATING, B. A. 2014. APSIM - Evolution towards a new generation of agricultural systems simulation. *Environmental Modelling & Software*, 62, 327-350.
- HOOGENBOOM, G. 1994. Computer simulation in biology: A BASIC introduction: Robert E. Keen and James D. Spain. Wiley-Liss, New York, 1991. 498 pp. Price: US \$39.95 (paperback). ISBN 0 471 50971 X. Companion Software Diskette (no charge) ISBN 0 471 56189 4. Elsevier.
- HOOGENBOOM, G. The state-of-the art in crop modeling. Climate prediction and agriculture. Proc the START/WMO International Workshop held in Geneva, Switzerland, 1999. 27-29.
- HOOGENBOOM, G., HOOK, J. E. & THOMAS, D. L. 2002. Estimating Water Demand For Irrigation Using A Crop Simulation Model.
- HOOGENBOOM, G., JONES, J. & BOOTE, K. 1990. Modeling growth, development and yield of legumes: current status of the SOYGRO, PNUTGRO and BEANGRO models. *Paper-American Society of Agricultural Engineers (USA)*. no. 90-7060.
- HOOGENBOOM, G., JONES, J. W. & BOOTE, K. J. 1992. Modeling Growth, Development, and Yield of Grain Legumes using Soygro, Pnutgro, and Beangro: A Review. *Transactions of the ASAE*, 35, 2043-2056.
- HORNIK, K. 2017. *R FAQ* [Online]. Available: [https://cran.r-project.org/doc/FAQ/R-FAQ.html#What-is-R\\_003f](https://cran.r-project.org/doc/FAQ/R-FAQ.html#What-is-R_003f) [Accessed].
- HU, S. & BIAN, L. 2009. Interoperability of functions in environmental models – a case study in hydrological modeling. *International Journal of Geographical Information Science*, 23, 657-681.
- HUISMAN, J. A., BREUER, L., BORMANN, H., BRONSTERT, A., CROKE, B. F. W., FREDE, H.-G., GRÄFF, T., HUBRECHTS, L., JAKEMAN, A. J., KITE, G., LANINI, J., LEAVESLEY, G., LETTENMAIER, D. P., LINDSTRÖM, G., SEIBERT, J., SIVAPALAN, M., VINEY, N. R. & WILLEMS, P. 2009. Assessing the impact of land use change on hydrology by ensemble modeling (LUCHEM) III: Scenario analysis. *Advances in Water Resources*, 32, 159-170.

---

# References

---

## References

- HUTH, N. I., CARBERRY, P. S., POULTON, P. L., BRENNAN, L. E. & KEATING, B. A. 2002. A framework for simulating agroforestry options for the low rainfall areas of Australia using APSIM. *European Journal of Agronomy*, 18, 171-185.
- IACOBELLIS, V., CASTORANI, A., DI SANTO, A. R. & GIOIA, A. 2015. Rationale for flood prediction in karst endorheic areas. *Journal of Arid Environments*, 112, 98-108.
- IACOBELLIS, V., CLAPS, P. & FIORENTINO, M. 2002. Climatic control on the variability of flood distribution. *Hydrology and Earth System Sciences*, 6, 229-238.
- IACOBELLIS, V., GIOIA, A., MILELLA, P., SATALINO, G., BALENZANO, A. & MATTIA, F. 2013. Inter-comparison of hydrological model simulations with time series of SAR-derived soil moisture maps. *European Journal of Remote Sensing*, 46, 739-757.
- INES, A. V. M., DROOGERS, P., MAKIN, I. W. & GUPTA, A. D. 2001. Water Crop Growth and Soil Water Balance Water Modeling to Explore Water Management Options. *Options, Working Paper 22*.
- INTERNATIONAL RESEARCH INSTITUTE FOR, C., SOCIETY, MICHIGAN STATE, U. & HARVESTCHOICE, I. F. P. R. I. 2015. Global High-Resolution Soil Profile Database for Crop Modeling Applications. Harvard Dataverse.
- INTERNATIONAL RESEARCH INSTITUTE FOR, C., SOCIETY, MICHIGAN STATE, U. & HARVESTCHOICE, I. F. P. R. I. 2018. Global High-Resolution Soil Profile Database for Crop Modeling Applications. Harvard Dataverse.
- ITTERSUM, M. V., HOWDEN, S. & ASSENG, S. 2003. Sensitivity of productivity and deep drainage of wheat cropping systems in a Mediterranean environment to changes in CO<sub>2</sub>, temperature and precipitation. *Agriculture, Ecosystems & ...*
- JAJARMIZADEH, M., HARUN, S. & SALARPOUR, M. 2012. A Review of Theoretical Consideration and Types of Models In Hydrology.pdf. *Journal of Environmental Science and Technology*, 5, 249-261.
- JALLAS, E., SEQUEIRA, R., MARTIN, P., TURNER, S. & CRÉTENET, M. COTONS, a cotton simulation model for the next century. *In: GILLHAM FRED, M., ed. World*

---

# References

---

## References

- Cotton Research Conference, 1998-09-06 / 1998-09-12 2000 Athènes, Grèce. none: ICAC, 518-521.
- JIA, Y. 2011. Coupling crop growth and hydrologic models to predict crop yield with spatial analysis technologies. *Journal of Applied Remote Sensing*, 5.
- JIA, Y., NI, G., KAWAHARA, Y. & SUETSUGI, T. 2001. Development of WEP model and its application to an urban watershed. *Hydrological Processes*, 15, 2175-2194.
- JIA, Y. W., SHEN, S. H., NIU, C. W., QIU, Y. Q., WANG, H. & LIU, Y. 2011. Coupling crop growth and hydrologic models to predict crop yield with spatial analysis technologies. *Journal of Applied Remote Sensing*, 5, 053537.
- JING, Q., SHANG, J. L., QIAN, B. D., HOOGENBOOM, G., HUFFMAN, T., LIU, J. G., MA, B. L., GENG, X. Y., JIAO, X. F., KOVACS, J. & WALTERS, D. 2016. Evaluation of the CSM-CROPGRO-Canola Model for Simulating Canola Growth and Yield at West Nipissing in Eastern Canada. *Agronomy Journal*, 108, 575-584.
- JONES, J., HOOGENBOOM, G., PORTER, C., BOOTE, K. & ... 2002. *The DSSAT cropping system modelling*, Elsevier Publ. Cie.
- JONES, J. W., ANTLE, J. M., BASSO, B., BOOTE, K. J., CONANT, R. T., FOSTER, I., GODFRAY, H. C. J., HERRERO, M., HOWITT, R. E., JANSSEN, S., KEATING, B. A., MUNOZ-CARPENA, R., PORTER, C. H., ROSENZWEIG, C. & WHEELER, T. R. 2017. Brief history of agricultural systems modeling. *Agricultural Systems*, 155, 240-254.
- JONES, J. W., HOOGENBOOM, G., PORTER, C. H., BOOTE, K. J., BATCHELOR, W. D., HUNT, L. A., WILKENS, P. W., SINGH, U., GIJSMAN, A. J. & RITCHIE, J. T. 2003. The DSSAT cropping system model. *European Journal of Agronomy*, 18, 235-265.
- JOPPICH, W., KURSCHNER, M. & TEAM, M. 2006. MpCCI - a tool for the simulation of coupled applications. *Concurrency and Computation-Practice & Experience*, 18, 183-192.

---

# References

---

## References

- JOSHI, N., SINGH, A. K. & MADRAMOOTOO, C. A. 2017. Application of Dssat Model to Simulate Corn Yield under Long-Term Tillage and Residue Practices. *Transactions of the Asabe*, 60, 67-83.
- KAKPAKOV, V. T. & POLUKAROVA, L. G. 1975. [Polyploidization and fusion of insect cells exposed to concanavalin A]. *Dokl Akad Nauk SSSR*, 223, 209-12.
- KAY, J. E., DESER, C., PHILLIPS, A., MAI, A., HANNAY, C., STRAND, G., ARBLASTER, J. M., BATES, S. C., DANABASOGLU, G., EDWARDS, J., HOLLAND, M., KUSHNER, P., LAMARQUE, J. F., LAWRENCE, D., LINDSAY, K., MIDDLETON, A., MUNOZ, E., NEALE, R., OLESON, K., POLVANI, L. & VERTENSTEIN, M. 2015. The Community Earth System Model (CESM) Large Ensemble Project: A Community Resource for Studying Climate Change in the Presence of Internal Climate Variability. *Bulletin of the American Meteorological Society*, 96, 1333-1349.
- KEATING, B. A., CARBERRY, P. S., HAMMER, G. L., PROBERT, M. E., ROBERTSON, M. J., HOLZWORTH, D., HUTH, N. I., HARGREAVES, J. N. G., MEINKE, H., HOCHMAN, Z., MCLEAN, G., VERBURG, K., SNOW, V., DIMES, J. P., SILBURN, M., WANG, E., BROWN, S., BRISTOW, K. L., ASSENG, S., CHAPMAN, S., MCCOWN, R. L., FREEBAIRN, D. M. & SMITH, C. J. 2003a. An overview of APSIM, a model designed for farming systems simulation. *European Journal of Agronomy*, 18, 267-288.
- KEATING, B. A., CARBERRY, P. S., HAMMER, G. L., PROBERT, M. E., ROBERTSON, M. J., HOLZWORTH, D., HUTH, N. I., HARGREAVES, J. N. G., MEINKE, H., HOCHMAN, Z., MCLEAN, G., VERBURG, K., SNOW, V., DIMES, J. P., SILBURN, M., WANG, E., BROWN, S., BRISTOW, K. L., ASSENG, S., CHAPMAN, S., MCCOWN, R. L., FREEBAIRN, D. M. & SMITH, C. J. 2003b. An overview of APSIM, a model designed for farming systems simulation. *European Journal of Agronomy*, 18, 267-288.
- KELLNER, J., MULTSCH, S., HOUSKA, T., KRAFT, P., MÜLLER, C. & BREUER, L. 2017. A coupled hydrological-plant growth model for simulating the effect of elevated

---

# References

---

## References

- CO<sub>2</sub> on a temperate grassland. *Agricultural and Forest Meteorology*, 246, 42-50.
- KHARBOUCHE, S., MULLER, J. P., GATEBE, C. K., SCANLON, T. & BANKS, A. C. 2017. Assessment of Satellite-Derived Surface Reflectances by NASA's CAR Airborne Radiometer over Railroad Valley Playa. *Remote Sensing*, 9.
- KINIRY, J. R., CASSIDA, K. A., HUSSEY, M. A., MUIR, J. P., OCUMPAUGH, W. R., READ, J. C., REED, R. L., SANDERSON, M. A., VENUTO, B. C. & WILLIAMS, J. R. 2005. Switchgrass simulation by the ALMANAC model at diverse sites in the southern US. *Biomass & Bioenergy*, 29, 419-425.
- KOTEY, B. A. 2017. Flexible working arrangements and strategic positions in SMEs. *Personnel Review*, 46, 355-370.
- KRAALINGEN, D. W. G. 1995. *The FSE system for crop simulation, version 2.1. Quantitative approaches in systems analysis No. 1.*
- KRAFT, P., VACHÉ, K. B., FREDE, H.-G. & BREUER, L. 2011. CMF: A Hydrological Programming Language Extension For Integrated Catchment Models. *Environmental Modelling & Software*, 26, 828-830.
- KROES, J. G., WESSELING, J. G. & VAN DAM, J. C. 2000. Integrated modelling of the soil-water-atmosphere-plant system using the model SWAP 20 an overview of theory and an application. *Hydrological Processes*, 14, 1993-2002.
- KUCHARIK, C. J. 2003. Evaluation of a Process-Based Agro-Ecosystem Model (Agro-IBIS) across the U.S. Corn Belt: Simulations of the Interannual Variability in Maize Yield. *Earth Interactions*, 7, 1-33.
- KUMAR, S. V., PETERS-LIDARD, C. D., TIAN, Y., HOUSER, P. R., GEIGER, J., OLDEN, S., LIGHTY, L., EASTMAN, J. L., DOTY, B., DIRMEYER, P., ADAMS, J., MITCHELL, K., WOOD, E. F. & SHEFFIELD, J. 2006. Land information system: An interoperable framework for high resolution land surface modeling. *Environmental Modelling & Software*, 21, 1402-1415.

---

# References

---

## References

- LAGARDE, T., PIACENTINI, A. & THUAL, O. 2001. A new representation of data-assimilation methods: The PALM flow-charting approach. *Quarterly Journal of the Royal Meteorological Society*, 127, 189-207.
- LAHLOU, M., SHOEMAKER, L., CHOUDHURY, S., ELMER, R. & HU, A. 1998. Better assessment science integrating point and nonpoint sources (BASINS), version 2.0. Users manual. Tetra Tech, Inc., Fairfax, VA (United States); EarthInfo, Inc., Boulder, CO (United States); Environmental Protection Agency, Standards and Applied Science Div., Washington, DC (United States).
- LAL, H., HOOGENBOOM, G., CALIXTE, J. P., JONES, J. W. & BEINROTH, F. H. 1993. Using Crop Simulation-Models and Gis for Regional Productivity Analysis. *Transactions of the Asae*, 36, 175-184.
- LAMBIN, E. F. & MEYFROIDT, P. 2011. Global land use change, economic globalization, and the looming land scarcity. *Proc Natl Acad Sci U S A*, 108, 3465-72.
- LAMBIN, E. F., ROUNSEVELL, M. D. A. & GEIST, H. J. 2000. Are agricultural land-use models able to predict changes in land-use intensity? *Agriculture, Ecosystems and Environment*, 82, 321-331.
- LARSON, J., JACOB, R. & ONG, E. 2005. The Model Coupling Toolkit: A new fortran90 toolkit for building multiphysics parallel coupled models. *International Journal of High Performance Computing Applications*, 19, 277-292.
- LEAVESLEY, G. H., RESTREPO, P. J., MARKSTROM, S. L., DIXON, M. & STANNARD, L. G. 1996. The Modular Modeling System (MMS): User's Manual. *Open-File Report*. Version 1.1 ed.
- LEI, H., YANG, D., LOKUPITIYA, E. & SHEN, Y. 2010. Coupling land surface and crop growth models for predicting evapotranspiration and carbon exchange in wheat-maize rotation croplands. *Biogeosciences*, 7, 3363-3375.
- LI, W. J., FU, H. H., YU, L. & CRACKNELL, A. 2017. Deep Learning Based Oil Palm Tree Detection and Counting for High-Resolution Remote Sensing Images. *Remote Sensing*, 9.

---

# References

---

## References

- LI, Y., ZHOU, J., KINZELBACH, W., CHENG, G., LI, X. & ZHAO, W. 2013. Coupling a SVAT heat and water flow model, a stomatal-photosynthesis model and a crop growth model to simulate energy, water and carbon fluxes in an irrigated maize ecosystem. *Agricultural and Forest Meteorology*, 176, 10-24.
- LI, Z. H., JIN, X. L., ZHAO, C. J., WANG, J. H., XU, X. G., YANG, G. J., LI, C. J. & SHEN, J. X. 2015a. Estimating wheat yield and quality by coupling the DSSAT-CERES model and proximal remote sensing. *European Journal of Agronomy*, 71, 53-62.
- LI, Z. T., YANG, J. Y., DRURY, C. F. & HOOGENBOOM, G. 2015b. Evaluation of the DSSAT-CSM for simulating yield and soil organic C and N of a long-term maize and wheat rotation experiment in the Loess Plateau of Northwestern China. *Agricultural Systems*, 135, 90-104.
- LIANG, H., HU, K., BATCHELOR, W. D., QI, Z. & LI, B. 2016. An integrated soil-crop system model for water and nitrogen management in North China. 6, 25755.
- LIANG, X., LETTENMAIER, D. P., WOOD, E. F. & BURGESS, S. J. 1994. A simple hydrologically based model of land surface water and energy fluxes for general circulation models. *Journal of Geophysical Research: Atmospheres*, 99, 14415-14428.
- LINDSTROM, G., JOHANSSON, B., PERSSON, M., GARDELIN, M. & BERGSTROM, S. 1997. Development and test of the distributed HBV-96 hydrological model. *Journal of Hydrology*, 201, 272-288.
- LINSTEAD, C. 2012. TDT: A Library for Typed Data Transfer. *Earth System Modelling - Volume 3: Coupling Software and Strategies*. Heidelberg, Berlin: Springer.
- LIU, H. L., YANG, J. Y., DRURY, C. F., REYNOLDS, W. D., TAN, C. S., BAI, Y. L., HE, P., JIN, J. & HOOGENBOOM, G. 2011. Using the DSSAT-CERES-Maize model to simulate crop yield and nitrogen cycling in fields under long-term continuous maize production. *Nutrient Cycling in Agroecosystems*, 89, 313-328.

---

# References

---

## References

- LIU, L., YANG, G., WANG, B., ZHANG, C., LI, R., ZHANG, Z., JI, Y. & WANG, L. 2014. C-Coupler1: a Chinese community coupler for Earth system modeling. *Geosci. Model Dev.*, 7, 2281-2302.
- LIZASO, J. I., BOOTE, K. J., JONES, J. W., PORTER, C. H., ECHARTE, L., WESTGATE, M. E. & SONOHAT, G. 2011. CSM-IXIM: A New Maize Simulation Model for DSSAT Version 4.5. *Agronomy Journal*, 103, 766-779.
- LOCHERER, M., HANK, T., DANNER, M. & MAUSER, W. 2015. Retrieval of Seasonal Leaf Area Index from Simulated EnMAP Data through Optimized LUT-Based Inversion of the PROSAIL Model. *Remote Sensing*, 7, 10321-10346.
- LOKUPITIYA, E., DENNING, S., PAUSTIAN, K., BAKER, I., SCHAEFER, K., VERMA, S., MEYERS, T., BERNACCHI, C. J., SUYKER, A. & FISCHER, M. 2009. Incorporation of crop phenology in Simple Biosphere Model (SiBcrop) to improve land-atmosphere carbon exchanges from croplands. *Biogeosciences*, 6, 969-986.
- LU, Y., JIN, J. & KUEPPERS, L. M. 2015. Crop growth and irrigation interact to influence surface fluxes in a regional climate-cropland model (WRF3.3-CLM4crop). *Climate Dynamics*, 45, 3347-3363.
- LUDÄSCHER, B., ALTINTAS, I., BERKLEY, C., HIGGINS, D., JAEGER, E., JONES, M., LEE, E. A., TAO, J. & ZHAO, Y. 2006. Scientific workflow management and the Kepler system. *Concurrency and Computation: Practice and Experience*, 18, 1039-1065.
- MA, L., AHUJA, L., NOLAN, B. T., MALONE, R., TROUT, T. & QI, Z. 2012. Root zone water quality model (RZWQM2): Model use, calibration and validation. *Transactions of the ASABE*, 55, 1425-1446.
- MA, L., HOOGENBOOM, G., AHUJA, L. R., ASCOUGH, J. C. & SASEENDRAN, S. A. 2006. Evaluation of the RZWQM-CERES-Maize hybrid model for maize production. *Agricultural Systems*, 87, 274-295.

---

# References

---

## References

- MA, L., HOOGENBOOM, G., AHUJA, L. R., NIELSEN, D. C. & ASCOUGH, J. C. 2005. Development and Evaluation of the RZWQM-CROPGRO Hybrid Model for Soybean Production. *Agronomy Journal*, 97.
- MAGOMBEYI, M. S. & TAIGBENU, A. E. 2011. An integrated modelling framework to aid smallholder farming system management in the Olifants River Basin, South Africa. *Physics and Chemistry of the Earth*, 36, 1012-1024.
- MAILHOL, J. C., OLUFAYO, A. A. & RUELLE, P. 1997. Sorghum and sunflower evapotranspiration and yield from simulated leaf area index. *Agricultural Water Management*, 35, 167-182.
- MALEK, K., STÖCKLE, C., CHINNAYAKANAHALLI, K., NELSON, R., LIU, M., RAJAGOPALAN, K., BARIK, M. & ADAM, J. C. 2017. VIC-CropSyst-v2: A regional-scale modeling platform to simulate the nexus of climate, hydrology, cropping systems, and human decisions. *Geosci. Model Dev.*, 10, 3059-3084.
- MALONE, R. W., MA, L. W., DON WAUCHOPE, R., AHUJA, L. R., ROJAS, K. W., MA, Q. L., WARNER, R. & BYERS, M. 2004. Modeling hydrology, metribuzin degradation and metribuzin transport in macroporous tilled and no-till silt loam soil using RZWQM. *Pest Management Science*, 60, 253-266.
- MANFREDA, S., FIORENTINO, M. & IACOBELLIS, V. 2005. DREAM: a distributed model for runoff, evapotranspiration, and antecedent soil moisture simulation. *Advances in Geosciences*, 2, 31-39.
- MANFREDA, S., SAMELA, C., GIOIA, A., CONSOLI, G. G., IACOBELLIS, V., GIUZIO, L., CANTISANI, A. & SOLE, A. 2015. Flood-prone areas assessment using linear binary classifiers based on flood maps obtained from 1D and 2D hydraulic models. *Natural Hazards*, 79, 735-754.
- MANFREDA, S., SMETTEM, K., IACOBELLIS, V., MONTALDO, N. & SIVAPALAN, M. 2010. Coupled ecological-hydrological processes. *Ecohydrology*, 3, 131-132.
- MARTINEZ-LOPEZ, J., BERTZKY, B., BONET-GARCIA, F. J., BASTIN, L. & DUBOIS, G. 2016. Biophysical Characterization of Protected Areas Globally through Optimized Image Segmentation and Classification. *Remote Sensing*, 8.

---

# References

---

## References

- MARUYAMA, A. & KUWAGATA, T. 2010. Coupling land surface and crop growth models to estimate the effects of changes in the growing season on energy balance and water use of rice paddies. *Agricultural and Forest Meteorology*, 150, 919-930.
- MAXWELL, T., VOINOV, A. & COSTANZA, R. 2004. Spatial Simulation Using the SME. *In: COSTANZA, R. & VOINOV, A. (eds.) Landscape Simulation Modeling: A Spatially Explicit, Dynamic Approach*. New York, NY: Springer New York.
- MCNIDER, R. T., HANDYSIDE, C., DOTY, K., ELLENBURG, W. L., CRUISE, J. F., CHRISTY, J. R., MOSS, D., SHARDA, V., HOOGENBOOM, G. & CALDWELL, P. 2015a. An integrated crop and hydrologic modeling system to estimate hydrologic impacts of crop irrigation demands. *Environmental Modelling & Software*, 72, 341-355.
- MCNIDER, R. T., HANDYSIDE, C., DOTY, K., ELLENBURG, W. L., CRUISE, J. F., CHRISTY, J. R., MOSS, D., SHARDA, V., HOOGENBOOM, G. & CALDWELL, P. 2015b. An integrated crop and hydrologic modeling system to estimate hydrologic impacts of crop irrigation demands. *Environmental Modelling and Software*, 72, 341-355.
- MEIYAPPAN, P., DALTON, M., O'NEILL, B. C. & JAIN, A. K. 2014. Spatial modeling of agricultural land use change at global scale. *Ecological Modelling*, 291, 152-174.
- MILELLA, P., BISANTINO, T., GENTILE, F., IACOBELLIS, V. & TRISORIO LIUZZI, G. 2012. Diagnostic analysis of distributed input and parameter datasets in Mediterranean basin streamflow modeling. *Journal of Hydrology*, 472-473, 262-276.
- MIMS. 2017. *MIMS Framework* [Online]. Available: <http://mimsfw.sourceforge.net/> [Accessed].
- MOLNÁR, Z., BALASUBRAMANIAN, D. & LÉDECZI, Á. An introduction to the generic modeling environment.

---

# References

---

## References

- MOORE, A. D., HOLZWORTH, D. P., HERRMANN, N. I., BROWN, H. E., DE VOIL, P. G., SNOW, V. O., ZURCHER, E. J. & HUTH, N. I. 2014. Modelling the manager: Representing rule-based management in farming systems simulation models. *Environmental Modelling & Software*, 62, 399-410.
- MOORE, A. D., HOLZWORTH, D. P., HERRMANN, N. I., HUTH, N. I. & ROBERTSON, M. J. 2007. The Common Modelling Protocol: A hierarchical framework for simulation of agricultural and environmental systems. *Agricultural Systems*, 95, 37-48.
- MULITZE, D. K. 1990. Agrobases/4 - a Microcomputer Database-Management and Analysis System for Plant-Breeding and Agronomy. *Agronomy Journal*, 82, 1016-1021.
- MÜLLER, J. P. A framework for integrated modeling using a knowledge-driven approach. In: DAVID A. SWAYNE, W. Y. A. A. V. A. R., ed. Conference of the International Environmental Modelling and Software Society, 2010-07-05 / 2010-07-08 2010 Ottawa, Canada. restricted: IEMSS, 1877-1884.
- MULTSCH, S., KRAFT, P., FREDE, H. & BREUER, L. Development and application of the generic Plant growth Modeling Framework (PMF). MODSIM2011 International Congress on Modelling and Simulation, Modelling and Simulation Society of Australia and New Zealand, 2011.
- NEGM, L. M., YOUSSEF, M. A., SKAGGS, R. W., CHESCHEIR, G. M. & JONES, J. 2014. DRAINMOD–DSSAT model for simulating hydrology, soil carbon and nitrogen dynamics, and crop growth for drained crop land. *Agricultural Water Management*, 137, 30-45.
- O'KEEFFE, J. M., GILMOUR, D. & SIMPSON, E. 2016. A network approach to overcoming barriers to market engagement for SMEs in energy efficiency initiatives such as the Green Deal. *Energy Policy*, 97, 582-590.
- OKORO, S. U., SCHICKHOFF, U., BOEHNER, J., SCHNEIDER, U. A. & HUTH, N. I. 2017. Climate impacts on palm oil yields in the Nigerian Niger Delta. *European Journal of Agronomy*, 85, 38-50.

---

# References

---

## References

- PAPAJORGJI, P., BECK, H. W. & BRAGA, J. L. 2004. An architecture for developing service-oriented and component-based environmental models. *Ecological Modelling*, 179, 61-76.
- PAUWELS, V. R. N., VERHOEST, N. E. C., DE LANNOY, G. J. M., GUISSARD, V., LUCAU, C. & DEFOURNY, P. 2007a. Optimization of a coupled hydrology–crop growth model through the assimilation of observed soil moisture and leaf area index values using an ensemble Kalman filter. *Water Resources Research*, 43, n/a-n/a.
- PAUWELS, V. R. N., VERHOEST, N. E. C., DE LANNOY, G. L. J. M., GUISSARD, V., LUCAU, C. & DEFOURNY, P. 2007b. Optimization of a coupled hydrology-crop growth model through the assimilation of observed soil moisture and leaf area index values using an ensemble Kalman filter. *Water Resources Research*, 43, 1-17.
- PECKHAM, S. 2008. Evaluation of model coupling frameworks for use by the community surface dynamics modeling system (CSDMS). *Proceedings of MODFLOW and MORE*. researchgate.net.
- PEREIRA, L. S., ALLEN, R. G., SMITH, M. & RAES, D. 2015. Crop evapotranspiration estimation with FAO56: Past and future. *Agricultural Water Management*, 147, 4-20.
- PERKEL, J. M. 2015. Programming: Pick up Python. *Nature*, 518, 125-6.
- PERSSON, T., GARCIA, A. G. Y., PAZ, J. O., ORTIZ, B. V. & HOOGENBOOM, G. 2010. Simulating the production potential and net energy yield of maize-ethanol in the southeastern USA. *European Journal of Agronomy*, 32, 272-279.
- PHAKAMAS, N., JINTRAWET, A., PATANOTHAI, A., SRINGAM, P. & HOOGENBOOM, G. 2013. Estimation of solar radiation based on air temperature and application with the DSSAT v4.5 peanut and rice simulation models in Thailand. *Agricultural and Forest Meteorology*, 180, 182-193.

---

# References

---

## References

- PROBERT, M. E., KEATING, B. A., THOMPSON, J. P. & PARTON, W. J. 1995. Modelling water, nitrogen, and crop yield for a long-term fallow management experiment. *Australian Journal of Experimental Agriculture*, 35, 941-950.
- QIU, L., DU, Z., ZHU, Q. & FAN, Y. 2017. An integrated flood management system based on linking environmental models and disaster-related data. *Environmental Modelling & Software*, 91, 111-126.
- RAHMAN, J., SEATON, S., PERRAUD, J., HOTHAM, H., VERRELLI, D. & COLEMAN, J. It's TIME for a new environmental modelling framework. Proceedings of MODSIM, 2003. 1727-1732.
- REFSGAARD, J. C. 1996. Terminology, Modelling Protocol And Classification of Hydrological Model Codes. *Distributed Hydrological Modelling*, 22, 17-39.
- REFSGAARD, J. C. & STORM, B. 1995. MIKE SHE. In: MILLER, P. C. (ed.) *computer Models of Catchment Hydrology*. Colorado, USA: Water Resources Publications.
- RIGOLOT, C., DE VOIL, P., DOUXCHAMPS, S., PRESTWIDGE, D., VAN WIJK, M., THORNTON, P. K., RODRIGUEZ, D., HENDERSON, B., MEDINA, D. & HERRERO, M. 2017. Interactions between intervention packages, climatic risk, climate change and food security in mixed crop-livestock systems in Burkina Faso. *Agricultural Systems*, 151, 217-224.
- RITCHIE, J. T., PORTER, C. H., JUDGE, J., JONES, J. W. & SULEIMAN, A. A. 2009. Extension of an Existing Model for Soil Water Evaporation and Redistribution under High Water Content Conditions. *Soil Science Society of America Journal*, 73, 792.
- RIZZOLI, A. E., DAVIS, J. R. & ABEL, D. J. 1998. Model and data integration and re-use in environmental decision support systems. *Decision Support Systems*, 24, 127-144.
- ROBERTSON, M. J., CARBERRY, P. S., HUTH, N. I., TURPIN, J. E., PROBERT, M. E., POULTON, P. L., BELL, M., WRIGHT, G. C., YEATES, S. J. & BRINSMEAD, R.

---

# References

---

## References

- B. 2002. Simulation of growth and development of diverse legume species in APSIM. *Australian Journal of Agricultural Research*, 53, 429-446.
- ROE, J., DIETZ, C., RESTREPO, P., HALQUIST, J., HARTMAN, R., HORWOOD, R., OLSEN, B., OPITZ, H., SHEDD, R. & WELLES, E. NOAA's community hydrologic prediction system. Proceedings from the 4th Federal Interagency Hydrologic Modeling Conference, 2010.
- ROSENTHAL, W., VANDERLIP, R., JACKSON, B. & ARKIN, G. 1989. SORKAM: A grain sorghum crop growth model. *Miscellaneous publication (USA)*.
- SALAS, D., LIANG, X. & LIANG, Y. 2012. A Systematic Approach for Hydrological Model Couplings \*. *Int. J. Communications, Network and System Sciences*, 5, 343-352.
- SANTHI, C., ARNOLD, J. G., WILLIAMS, J. R., DUGAS, W. A., SRINIVASAN, R. & HAUCK, L. M. 2001. Validation of the swat model on a large river basin with point and nonpoint sources. *JAWRA Journal of the American Water Resources Association*, 37, 1169-1188.
- SANTOS, R. D., BOOTE, K., SOLLENBERGER, L., NEVES, A. L. A., PEREIRA, L. G. R., SCHERER, C. B. & GONCALVES, L. C. 2016. Simulated optimum sowing date for forage pearl millet cultivars in multilocation trials in Brazilian semi-arid region. *Frontiers in Plant Science*, 7, 1320.
- SASEENDRAN, S. A., MA, L., MALONE, R., HEILMAN, P., AHUJA, L. R., KANWAR, R. S., KARLEN, D. L. & HOOGENBOOM, G. 2007. Simulating, management effects on crop production, tile drainage, and water quality using RZWQM-DSSAT. *Geoderma*, 140, 297-309.
- SASEENDRAN, S. A., NIELSEN, D. C., LYON, D. J., MA, L., FELTER, D. G., BALTENSBERGER, D. D., HOOGENBOOM, G. & AHUJA, L. R. 2009. Modeling responses of dryland spring triticale, proso millet and foxtail millet to initial soil water in the High Plains. *Field Crops Research*, 113, 48-63.

---

# References

---

## References

- SASEENDRAN, S. A., NIELSEN, D. C., MA, L. & AHUJA, L. R. 2010. Adapting CROPGRO for Simulating Spring Canola Growth with Both RZWQM2 and DSSAT 4.0. *Agronomy Journal*, 102, 1606-1621.
- SAWIK, T. 1995. Integer Programming-Models for the Design and Balancing of Flexible Assembly Systems. *Mathematical and Computer Modelling*, 21, 1-12.
- SCHNABLE, P. S., WARE, D., FULTON, R. S., STEIN, J. C., WEI, F., PASTERNAK, S., LIANG, C., ZHANG, J., FULTON, L., GRAVES, T. A., MINX, P., REILY, A. D., COURTNEY, L., KRUCHOWSKI, S. S., TOMLINSON, C., STRONG, C., DELEHAUNTY, K., FRONICK, C., COURTNEY, B., ROCK, S. M., BELTER, E., DU, F., KIM, K., ABBOTT, R. M., COTTON, M., LEVY, A., MARCHETTO, P., OCHOA, K., JACKSON, S. M., GILLAM, B., CHEN, W., YAN, L., HIGGINBOTHAM, J., CARDENAS, M., WALIGORSKI, J., APPLEBAUM, E., PHELPS, L., FALCONE, J., KANCHI, K., THANE, T., SCIMONE, A., THANE, N., HENKE, J., WANG, T., RUPPERT, J., SHAH, N., ROTTER, K., HODGES, J., INGENTHRON, E., CORDES, M., KOHLBERG, S., SGRO, J., DELGADO, B., MEAD, K., CHINWALLA, A., LEONARD, S., CROUSE, K., COLLURA, K., KUDRNA, D., CURRIE, J., HE, R., ANGELOVA, A., RAJASEKAR, S., MUELLER, T., LOMELI, R., SCARA, G., KO, A., DELANEY, K., WISSOTSKI, M., LOPEZ, G., CAMPOS, D., BRAIDOTTI, M., ASHLEY, E., GOLSER, W., KIM, H., LEE, S., LIN, J., DUJMIC, Z., KIM, W., TALAG, J., ZUCCOLO, A., FAN, C., SEBASTIAN, A., KRAMER, M., SPIEGEL, L., NASCIMENTO, L., ZUTAVERN, T., MILLER, B., AMBROISE, C., MULLER, S., SPOONER, W., NARECHANIA, A., REN, L., WEI, S., KUMARI, S., FAGA, B., LEVY, M. J., MCMAHAN, L., VAN BUREN, P., VAUGHN, M. W., et al. 2009. The B73 maize genome: complexity, diversity, and dynamics. *Science*, 326, 1112-5.
- SCHULLA, J. & JASPER, K. 2007. Model description wasim-eth. *Institute for Atmospheric and Climate Science, Swiss Federal Institute of Technology, Zürich*.

---

# References

---

## References

- SEHGAL, V. K. & SASTRI, C. V. S. 2005. Simulating the Effect of Nitrogen Application on Wheat Yield by Linking Remotely Sensed Measurements with Wtgrows Simulation Model. *Photonirvachak-Journal of the Indian Society of Remote Sensing*, 33, 297-305.
- SELLERS, P. J., RANDALL, D. A., COLLATZ, G. J., BERRY, J. A., FIELD, C. B., DAZLICH, D. A., ZHANG, C., COLLELO, G. D. & BOUNOUA, L. 1996. A Revised Land Surface Parameterization (SiB2) for Atmospheric GCMS. Part I: Model Formulation. *Journal of Climate*, 9, 676-705.
- SHELIA, V., SIMUNEK, J., BOOTE, K. & HOOGENBOOM, G. 2017. Coupled the DSSAT and Hydrus-1D for Soil Water Dynamics Simulation in the Soil-Plant-Atmosphere System. (ASA, CSSA and SSSA International Annual Meetings (2016)). *Phoenix Convention Center North, Exhibit Hall CDE*.
- SHIROKANOV, D. I. 2014. Integration Processes in Modern Society: Dialectics of Global and Local. *Procedia Economics and Finance*, 8, 664-670.
- SIAD, S. M., GIOIA, A., HOOGENBOOM, G., IACOBELLIS, V., NOVELLI, A., TARANTINO, E. & ZDRULI, P. 2017. Durum Wheat Cover Analysis in the Scope of Policy and Market Price Changes: A Case Study in Southern Italy. *Agriculture*, 7, 12.
- SIMUNEK, J. & VAN GENUCHTEN, M. 1994. THE CHAIN\_2D CODE FOR SIMULATING TWO-DIMENSIONAL MOVEMENT OF WATER FLOW, HEAT, AND MULTIPLE SOLUTES IN VARIABLY-SATURATED POROUS MEDIA, VERSION 1.1 USSL RESEARCH REPORT NO. 136. *Laboratory Publication*.
- SIMUNEK, J., VAN GENUCHTEN, M. T. & SEJNA, M. 2005. The HYDRUS-1D software package for simulating the one-dimensional movement of water, heat, and multiple solutes in variably-saturated media. *University of California-Riverside Research Reports*, 3, 1-240.
- SINCLAIR, T. R. & SELIGMAN, N. A. G. 1996. Crop Modeling: From Infancy to Maturity. *Agronomy Journal*, 88.
- SINGH, P. & VIRMANI, S. M. 1996. Modeling growth and yield of chickpea (*Cicer arietinum* L). *Field Crops Research*, 46, 41-59.

---

# References

---

## References

- SKAGGS, R., FALK, C., ALMONTE, J. & CARDENAS, M. 1996. Product-country images and international food marketing: Relationships and research needs. *Agribusiness*, 12, 593-600.
- SKAMAROCK, W. C., KLEMP, J. B. & DUDHIA, J. Prototypes for the WRF (Weather Research and Forecasting) model. Preprints, Ninth Conf. Mesoscale Processes, J11–J15, Amer. Meteorol. Soc., Fort Lauderdale, FL, 2001.
- SKOVDAL CHRISTIANSEN, J., THORSEN, M., CLAUSEN, T., HANSEN, S. & CHRISTIAN REFSGAARD, J. 2004. Modelling of macropore flow and transport processes at catchment scale. *Journal of Hydrology*, 299, 136-158.
- SOLER, C. M. T., SENTELHAS, P. C. & HOOGENBOOM, G. 2007a. Application of the CSM-CERES-Maize model for planting date evaluation and yield forecasting for maize grown off-season in a subtropical environment. *European Journal of ...*
- SOLER, C. M. T., SENTELHAS, P. U. & HOOGENBOOM, G. 2007b. Application of the CSM-CERES-maize model for planting date evaluation and yield forecasting for maize grown off-season in a subtropical environment. *European Journal of Agronomy*, 27, 165-177.
- SONODA, E. & TRAVIESO, G. 2006. The OOPS framework: high level ions for the development of parallel scientific applications. *Companion to the 21st ACM SIGPLAN symposium on Object-oriented programming systems, languages, and applications*. Portland, Oregon, USA: ACM.
- STEHFEST, E., HEISTERMANN, M., PRIESS, J. A., OJIMA, D. S. & ALCAMO, J. 2007. Simulation of global crop production with the ecosystem model DayCent. *Ecological Modelling*, 209, 203-219.
- STÖCKLE, C. O., DONATELLI, M. & NELSON, R. 2003. CropSyst, a cropping systems simulation model. *European Journal of Agronomy*, 18, 289-307.
- SULEIMAN, A. A. & RITCHIE, J. T. 2004. Modifications to the DSSAT vertical drainage model for more accurate soil water dynamics estimation. *Soil Science*, 169, 745-757.

---

# References

---

## References

- SYDELKO, P. J., DOLPH, J. E., MAJERUS, K. A. & TAXON, T. N. Sponsor Org.: US Department of Energy (US). A dynamic object-oriented architecture approach to ecosystem modeling and simulation. 1999-04-09 1999 United States. Research Org.: Argonne National Lab., IL (US).
- THANAPAKPAWIN, P., RICHEY, J., THOMAS, D., RODDA, S., CAMPBELL, B. & LOGSDON, M. 2007. Effects of landuse change on the hydrologic regime of the Mae Chaem river basin, NW Thailand. *Journal of Hydrology*, 334, 215-230.
- THIRUP, C. 2013. Nitrate leaching in the Norsminde catchment. *NiCA Technical Note*, Available at [www.nitrate.dk](http://www.nitrate.dk).
- THIRUP, C., GRAHAM, D. N. & J.C., R. 2014. DAISY-MIKE SHE coupling using OpenMI. *NiCA Technical Note*, Available at [www.nitrate.dk](http://www.nitrate.dk).
- THORNTON, P. K. & HOOGENBOOM, G. 1994. A computer program to analyze single-season crop model outputs. *Agronomy Journal*, 86, 860-868.
- THURMAN, D. A., COWELL, A. J., TAIRA, R. Y. & FRODGE, J. 2004. Designing a collaborative problem solving environment for integrated water resource modeling. *Brownfields: Multimedia Modelling and Assessment*, 71, 87-94.
- TSAROUCHI, G. M., BUYTAERT, W. & MIJIC, A. 2014. Coupling a land-surface model with a crop growth model to improve ET flux estimations in the Upper Ganges basin, India. *Hydrology and Earth System Sciences*, 18, 4223-4238.
- USACE. 2017. *Adaptive Risk Assessment Modeling System (ARAMS)* [Online]. Available: <http://www.erdc.usace.army.mil/Media/Fact-Sheets/Fact-Sheet-Article-View/Article/500113/adaptive-risk-assessment-modeling-system-arams/> [Accessed].
- VALCKE, S. 2013. The OASIS3 coupler: a European climate modelling community software. *Geoscientific Model Development*, 6, 373-388.
- VAN DEN HOOFF, C., HANERT, E. & VIDALE, P. L. 2011. Simulating dynamic crop growth with an adapted land surface model – JULES-SUCROS: Model development and validation. *Agricultural and Forest Meteorology*, 151, 137-153.

---

# References

---

## References

- VAN DIEPEN, C. A., WOLF, J., VAN KEULEN, H. & RAPPOLDT, C. 1989. WOFOST: a simulation model of crop production. *Soil Use and Management*, 5, 16-24.
- VAN ITTERSUM, M. K., EWERT, F., HECKELEI, T., WERY, J., OLSSON, J. A., ANDERSEN, E., BEZLEPKINA, I., BROUWER, F., DONATELLI, M. & FLICHTMAN, G. 2008. Integrated assessment of agricultural systems—A component-based framework for the European Union (SEAMLESS). *Agricultural systems*, 96, 150-165.
- VAN KRAALINGEN, D. W. G., RAPPOLDT, C. & VAN LAAR, H. H. 2003. The Fortran simulation translator, a simulation language. *European Journal of Agronomy*, 18, 359-361.
- VANUYTRECHT, E. & THORBURN, P. J. 2017. Responses to atmospheric CO<sub>2</sub> concentrations in crop simulation models: a review of current simple and semicomplex representations and options for model development. *Global Change Biology*, 23, 1806-1820.
- VAZQUEZ, R. F., BEVEN, K. & FEYEN, J. 2009. GLUE Based Assessment on the Overall Predictions of a MIKE SHE Application. *Water Resources Management*, 23, 1325-1349.
- VENTRELLA, D., CHARFEDDINE, M., MORIONDO, M., RINALDI, M. & BINDI, M. 2012. Agronomic adaptation strategies under climate change for winter durum wheat and tomato in southern Italy: irrigation and nitrogen fertilization. *Regional Environmental Change*, 12, 407-419.
- VIANNA, M. D. & SENTELHAS, P. C. 2016. Performance of DSSAT CSM-CANEGRO Under Operational Conditions and its Use in Determining the 'Saving Irrigation' Impact on Sugarcane Crop. *Sugar Tech*, 18, 75-86.
- VILLA, F. 2007. A semantic framework and software design to enable the transparent integration, reorganization and discovery of natural systems knowledge. *Journal of Intelligent Information Systems*, 29, 79-96.
- VINEY, N. R., BORMANN, H., BREUER, L., BRONSTERT, A., CROKE, B. F. W., FREDE, H., GRÄFF, T., HUBRECHTS, L., HUISMAN, J. A., JAKEMAN, A. J., KITE, G. W.,

---

# References

---

## References

- LANINI, J., LEAVESLEY, G., LETTENMAIER, D. P., LINDSTRÖM, G., SEIBERT, J., SIVAPALAN, M. & WILLEMS, P. 2009. Assessing the impact of land use change on hydrology by ensemble modelling (LUCHEM) II: Ensemble combinations and predictions. *Advances in Water Resources*, 32, 147-158.
- VINEY, N. R. & SIVAPALAN, M. 2001. Modelling catchment processes in the Swan–Avon river basin. *Hydrological Processes*, 15, 2671-2685.
- VOINOV, A., FITZ, C., BOUMANS, R. & COSTANZA, R. 2004. Modular ecosystem modeling. *Environmental Modelling & Software*, 19, 285-304.
- WAHA, K., VAN BUSSEL, L. G. J., MÜLLER, C. & BONDEAU, A. 2012. Climate-driven simulation of global crop sowing dates. *Global Ecology and Biogeography*, 21, 247-259.
- WALLACH, D. & RELIER, J. P. 1987. Agrobase - a Database Management-System for Experimental-Data. *Agronomie*, 7, 739-742.
- WANG, J., HUANG, G., ZHAN, H., MOHANTY, B. P., ZHENG, J., HUANG, Q. & XU, X. 2014. Evaluation of soil water dynamics and crop yield under furrow irrigation with a two-dimensional flow and crop growth coupled model. *Agricultural Water Management*, 141, 10-22.
- WANG, X., LIU, G., YANG, J., HUANG, G. & YAO, R. 2017. Evaluating the effects of irrigation water salinity on water movement, crop yield and water use efficiency by means of a coupled hydrologic/crop growth model. *Agricultural Water Management*, 185, 13-26.
- WAONGO, M., LAUX, P. & KUNSTMANN, H. 2015. Adaptation to climate change: The impacts of optimized planting dates on attainable maize yields under rainfed conditions in Burkina Faso. *Agricultural and Forest Meteorology*, 205, 23-39.
- WATSON, F., VERTESSY, R. A., GRAYSON, R. B. & PIERCE, L. L. 1998. *Towards parsimony in large scale hydrological modelling - Australian and Californian experience with the Macaque model*.
- WEBB, J., MISSELBROOK, T. H., TSCHARNTKE, T., CLOUGH, Y., WANGER, T. C., JACKSON, L., MOTZKE, I., PERFECTO, I., VANDERMEER, J., WHITBREAD, A.,

---

# References

---

## References

- TILMAN, D., CASSMAN, K. G., MATSON, P. A., NAYLOR, R., POLASKY, S., BALZER, C., HILL, J., BEFORT, B. L., THÉVENOT, A., AUBIN, J., TILLARD, E., VAYSSIÈRES, J., INSTITUTE, T. M., SCIENCE, T. G. O. F., STOLZE, M., LAMPKIN, N., STEHFEST, E., BOUWMAN, L., VAN VUUREN, D. P., DEN ELZEN, M. G. J., EICKHOUT, B., KABAT, P., SEUFERT, V., SERVICES, C., SCIALABBA, N. E.-H., PRODUCTION, S. F., POWERS, W. J., ANGEL, C. R., APPLGATE, T. J., PLAN, S., PHALAN, B., BALMFORD, A., GREEN, R. E., SCHARLEMANN, J. P. W., PELLETIER, N., TYEDMERS, P., SMITH, P., MUIR, J. F., PRETTY, J., ROBINSON, S., THOMAS, S. M., TOULMIN, C., MEIER, M. S., STOESSEL, F., JUNGBLUTH, N., JURASKE, R., SCHADER, C., STOLZE, M., MCMICHAEL, A. J., POWLES, J. W., BUTLER, C. D., UAUY, R., KRATLI, S., HUELSEBUSCH, C., BROOKS, S., KAUFMANN, B., KONESWARAN, G., NIERENBERG, D., GREGORY, P. J., GEORGE, T. S., GODFRAY, H. C. J., GARNETT, T., GASES, H., FAO, DE VRIES, M., DE BOER, I. J. M., CLAIRE, L., STÉPHANE, B., CHAPPELL, M. J., LAVALLE, L. A., CHADWICK, D., SOMMER, S., THORMAN, R., FANGUEIRO, D., CARDENAS, L., AMON, B., MISSELBROOK, T. H., BODY, U. S., ADVICE, T., SOCIETY, W., BARLING, D., SHARPE, R., LANG, T., APPLICATION, D. F., SERVICES, S. F., BRIDGE, S., ALEXANDRATOS, N., BRUINSMA, J. & ADAS 2011. Foresight. The Future of Food and Farming: Challenges and choices for global sustainability. *The Government Office for Science, London*, 149, 193-208.
- WEBBER, H. A., MADRAMOOTOO, C. A., BOURGAULT, M., HORST, M. G., STULINA, G. & SMITH, D. L. 2010. Adapting the CROPGRO model for saline soils: The case for a common bean crop. *Irrigation Science*, 28, 317-329.
- WEERTS, A. H., EL SERAFY, G. Y., HUMMEL, S., DHONDIA, J. & GERRITSEN, H. 2010. Application of generic data assimilation tools (DATools) for flood forecasting purposes. *Computers & Geosciences*, 36, 453-463.

---

# References

---

## References

- WERNER, M., SCHELLEKENS, J., GIJSBERS, P., VAN DIJK, M., VAN DEN AKKER, O. & HEYNERT, K. 2013. The Delft-FEWS flow forecasting system. *Environmental Modelling & Software*, 40, 65-77.
- WHITE, J. W., HOOGENBOOM, G., KIMBALL, B. A. & WALL, G. W. 2011a. Methodologies for simulating impacts of climate change on crop production. *Field Crops Research*, 124, 357-368.
- WHITE, J. W., HOOGENBOOM, G., KIMBALL, B. A. & WALL, G. W. 2011b. Methodologies for simulating impacts of climate change on crop production. *Field Crops Research*, 124, 357-368.
- WHITE, J. W., HOOGENBOOM, G., WILKENS, P. W., STACKHOUSE, P. W. & HOEL, J. M. 2011c. Evaluation of Satellite-Based, Modeled-Derived Daily Solar Radiation Data for the Continental United States. *Agronomy Journal*, 103, 1242-1251.
- WIEGAND, C. & RICHARDSON, A. 1984. Leaf area, light interception, and yield estimates from spectral components analysis. *Agronomy Journal*, 76, 543-548.
- WIGMOSTA, M. S., NIJSSEN, B., STORCK, P. & LETTENMAIER, D. 2002. The distributed hydrology soil vegetation model. *Mathematical models of small watershed hydrology and applications*, 7-42.
- WILEDEN, J. C. & KAPLAN, A. 1999. Software interoperability. 675-676.
- WILL, A., AKHTAR, N., BRAUCH, J., BREIL, M., DAVIN, E., HO-HAGEMANN, H. T. M., MAISONNAVE, E., THURKOW, M. & WEIHER, S. 2017. The COSMO-CLM 4.8 regional climate model coupled to regional ocean, land surface and global earth system models using OASIS3-MCT: description and performance. *Geoscientific Model Development*, 10, 1549-1586.
- WILLIAMS, J. R. 1990. The erosion-productivity impact calculator (EPIC) model: a case history. *Philosophical Transactions of the Royal Society of London B: Biological Sciences*, 329, 421-428.
- WIT, A. D. 2017. *PCSE: The Python Crop Simulation Environment* [Online]. Available: <http://pcse.readthedocs.io> [Accessed].

---

# References

---

## References

- WOLLHEIM, W. M., VOROSMARTY, C. J., BOUWMAN, A. F., GREEN, P., HARRISON, J., LINDER, E., PETERSON, B. J., SEITZINGER, S. P. & SYVITSKI, J. P. M. 2008. Global N removal by freshwater aquatic systems using a spatially distributed, within-basin approach. *Global Biogeochemical Cycles*, 22.
- WOLSTENCROFT, K., HAINES, R., FELLOWS, D., WILLIAMS, A., WITHERS, D., OWEN, S., SOILAND-REYES, S., DUNLOP, I., NENADIC, A., FISHER, P., BHAGAT, J., BELHAJJAME, K., BACALL, F., HARDISTY, A., DE LA HIDALGA, A. N., VARGAS, M. P. B., SUFI, S. & GOBLE, C. 2013. The Taverna workflow suite: designing and executing workflows of Web Services on the desktop, web or in the cloud. *Nucleic Acids Research*, 41, W557-W561.
- WU, S. L. & CRESTANI, F. 2003. Distributed information retrieval: A multi-objective resource selection approach. *International Journal of Uncertainty Fuzziness and Knowledge-Based Systems*, 11, 83-99.
- XU, X., HUANG, G., SUN, C., PEREIRA, L. S., RAMOS, T. B., HUANG, Q. & HAO, Y. 2013. Assessing the effects of water table depth on water use, soil salinity and wheat yield: Searching for a target depth for irrigated areas in the upper Yellow River basin. *Agricultural Water Management*, 125, 46-60.
- YANG, J. Y. & HUFFMAN, E. C. 2004. EasyGrapher: software for graphical and statistical validation of DSSAT outputs. *Computers and Electronics in Agriculture*, 45, 125-132.
- YAO, D. D. & BUZACOTT, J. A. 1986. The Exponentialization Approach to Flexible Manufacturing System Models with General Processing Times. *European Journal of Operational Research*, 24, 410-416.
- YELLIN, D. M. 2001. Stuck in the middle: Challenges and trends in optimizing middleware. *Acm Sigplan Notices*, 36, 175-180.
- YOSHIMURA, H. & YUKIMOTO, S. 2008. Development of a Simple Coupler (Scup) for Earth System Modeling. *Papers in Meteorology and Geophysics*, 59, 19-29.

---

# References

---

## References

- YU, Q., SASEENDRAN, S. A., MA, L., FLERCHINGER, G. N., GREEN, T. R. & AHUJA, L. R. 2006. Modeling a wheat-maize double cropping system in China using two plant growth modules in RZWQM. *Agricultural Systems*, 89, 457-477.
- YUEI-AN, L. & ENGLAND, A. W. 1998. A land-surface process/radiobrightness model with coupled heat and moisture transport for freezing soils. *IEEE Transactions on Geoscience and Remote Sensing*, 36, 669-677.
- ZHANG, G., ZHOU, J., ZHOU, Q., CHENG, G. & LI, X. 2012. Integrated Eco-hydrological modelling by a combination of coupled-model and algorithm using OMS3.
- ZHANG, Y. Y., SHAO, Q. X., YE, A. Z. & XING, H. T. 2014. An integrated water system model considering hydrological and biogeochemical processes at basin scale: model construction and application. *Hydrology and Earth System Sciences Discussions*, 11, 9219-9279.
- ZHOU, J., CHENG, G., LI, X., HU, B. X. & WANG, G. 2012. Numerical Modeling of Wheat Irrigation using Coupled HYDRUS and WOFOST Models. *Soil Science Society of America Journal*, 76.