



# An overview of grid-edge control with the digital transformation

Tam T. Mai<sup>1</sup> · Phuong H. Nguyen<sup>1</sup> · Quoc-Tuan Tran<sup>2</sup> · Alessia Cagnano<sup>3</sup> · Giovanni De Carne<sup>4</sup> · Yassine Amirat<sup>5</sup> · Anh-Tuan Le<sup>6</sup> · Enrico De Tuglie<sup>3</sup>

Received: 18 August 2020 / Accepted: 29 December 2020 / Published online: 3 February 2021  
© The Author(s) 2021

## Abstract

Distribution networks are evolving to become more responsive with increasing integration of distributed energy resources (DERs) and digital transformation at the grid edges. This evolution imposes many challenges to the operation of the network, which then calls for new control and operation paradigms. Among others, a so-called grid-edge control is emerging to harmonise the coexistence of the grid control system and DER's autonomous control. This paper provides a comprehensive overview of the grid-edge control with various control architectures, layers, and strategies. The challenges and opportunities for such an approach at the grid edge with the integration of DERs and digital transformation are summarised. The potential solutions to support the network operation by using the inherent controllability of DER and the availability of the digital transformation at the grid edges are discussed.

**Keywords** Grid-edge control · Distributed energy resources · Microgrids · Real-time simulations · Power quality

## 1 Introduction

The energy transition is undergoing in all levels of the electricity grid with increasing penetration of renewable energy sources (RES), especially wind and solar photovoltaic (PV). This transition towards more environment-friendly operation based on electrifications is also occurring in other energy sectors, such as the transport and the heating/cooling [1]. Specifically, the former opts for the adoption of electric vehicles (EVs) to substitute the fossil fuel vehicles, while the latter aims to replace gas-fired heaters by heat pumps (HPs). RESs, EVs and HPs constitute the distributed energy resources (DERs) which create both challenges and opportunities to optimise performance of distribution networks.

The integration of DERs at the customers' premises reduces the network power losses while increasing the end-users' control over their electricity consumption and enabling them to be actively involved in the electricity market [2]. Furthermore, DERs are capable of reshaping their generation, i.e. RES and energy storage systems (ESS), and consumption patterns, i.e. EVs and flexible loads, providing flexibility services for the grid operation. Despite all of these improvements, massive integration of DERs in low-voltage (LV) and medium-voltage (MV) grids has adverse impacts on the network operation and power quality. The intermittency of PVs causes fast voltage fluctuations [3], while the abrupt charging of EVs causes the voltage sag and unbalance [4]. Addressing these adverse impacts involves changes in the network planning and operation, e.g. reinforcements of network components and operation of power quality supporting equipment, to increasingly accommodate DERs while maintaining network voltage quality.

Additionally, distribution networks are evolving from the traditional, passive system into the smart, active system, resulting from the rapid digital transformation at the grid edges, i.e. the secondary side of LV distribution transformers. The digital transformation arises from the adoption of advanced sensors, smart meters (SM) as well as the emerging development of Internet-of-things (IoT) that allows devices to be connected with two-way communication. For

---

✉ Tam T. Mai  
t.t.mai@tue.nl

<sup>1</sup> Eindhoven University of Technology, Eindhoven, The Netherlands

<sup>2</sup> LITEN, CEA, Grenoble, France

<sup>3</sup> Politecnico Di Bari, Bari, Italy

<sup>4</sup> Karlsruhe Institute of Technology, Karlsruhe, Germany

<sup>5</sup> ISEN Yncréa Ouest, Brest, France

<sup>6</sup> Chalmers University of Technology, Gothenburg, Sweden

this, the key drivers are the technological development, i.e. data integrity, cyber-physical systems, artificial intelligence (machine learning), big data, digital twins, for secured, flexible and efficient grid operation with cost reduction [5]. The digital transformation at the grid edges enables the LV distribution network to have digital structure, facilitating self-monitoring and self-healing capabilities [2]. Moreover, the active exploitation of advanced information and communication technologies (ICT) can enhance the controllability of DERs and the network [6]. The digital transformation at the grid edge, thus, would facilitate the optimal coordination of the customer-owned DERs at the grid edges [5] and for improving the efficiency of the power system operation [7]. As a result, the adoption of the digital transformation along with the inherent controllability of DERs, if properly managed, is expected to maximise the cost-effectiveness of incorporating DERs into the grid while maintaining or increasing system stability and reliability. In this respect, managing the network requires a new paradigm of DERs' control strategies, whose overview is presented in this paper. For this paradigm, it is crucial to leverage ICT, data-driven and machine learning-based methods given the increasing availability of the data measurement. In this context, a so-called grid-edge control refers to the control of DERs at the grid edges, which leverages various data resources from the digital transformation. Figure 1 illustrates the concept of grid-edge control.

As an example of the grid-edge control, the (grid-connected) microgrid (MG) is regarded as a cost-effective solution to the proper integration of DERs [8] as DERs' controllability can be effectively used to tackle their negative effect on the grid. An MG is a system composed of DERs that are electrically connected and coordinated to operate the MG as independent energy sources, which can interact with the utility grid or operate in isolated mode [9]. Review of the

control methods for DERs to support the MG operation can be found in [10–12], which focus on local control without using any communication among DERs. The shortcoming with this technique, however, is that the optimisation of the network performance is likely not achievable as DERs lack the awareness of system-wide performance and other units' status.

This paper provides a comprehensive overview of the grid-edge control, i.e. control of DERs (including PVs, EVs and HPs), which leverages various data resources from the digital transformation at the grid edges. As a part of this overview, the challenges of operating and controlling DERs are also examined. Next, the modelling and simulation of the grid-edge control to support grid performance are presented. Then, a thorough discussion of the architecture, layers and strategies for the grid-edge control is provided. The following section shows the particular use-cases for the grid-edge control. Finally, discussions on future trends with grid-edge control is presented.

## 2 Challenges from high DER penetration

As aforementioned, the high penetration of DERs at the grid edges causes several challenges for grid operation and planning. These challenges have arisen from the nature of DERs associated with the uncertainty, variability and no inertia as well as the regulation related to the system operation. In this section, analysis of these challenges is provided as a sound foundation for determining the proper control solutions. It is important to note that DERs in this section refer to PVs, EVs and HPs. Figure 2 lists a summary of the main challenges from high DER penetration.

### 2.1 Supply–demand balancing

DER technologies with their generation capability such as residential PVs have uncertain characteristics by nature, such as intermittency, randomness and variability [13]. Electricity

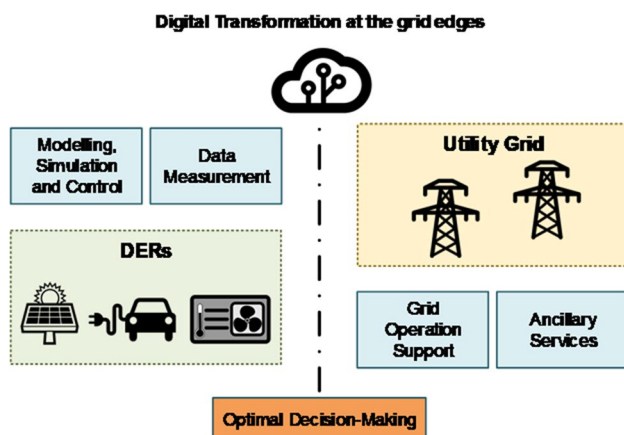

**Fig. 1** The grid-edge control is leveraging the data measurement from the digital transformation at the grid edges

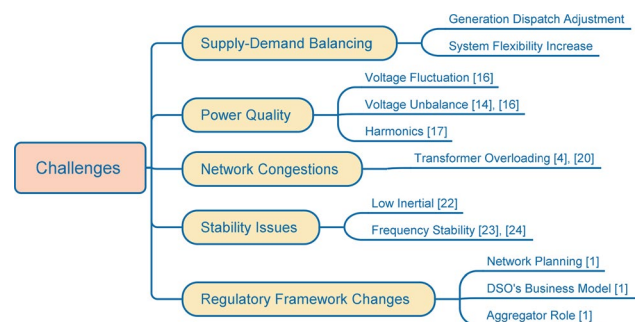

**Fig. 2** Main challenges for grid operation and planning due to high DER penetration

production from PV is inherently only available during the sunlight periods. Furthermore, their power outputs fluctuate over time according to the variation of the solar irradiation. Such uncertain nature causes the deployment of PVs to be challenging as the real-time grid operation will be disrupted.

As the primary renewable energy cannot be stored, its power output is discontinuously usable to supply the electricity demand. Moreover, fluctuation of PV power outputs with fast and frequent fashion adds more stress on real-time network operation procedure as the adjustments of power generation dispatches must be carried out quickly and more frequently. In this regard, the system flexibility to efficiently operating the entire system needs to increase. At the system level, the flexibility can be arranged by an adequate level of reserved power from generation-side resources. For this, many power plants must operate at power outputs below the rated value or with minimum values, eventually operate at standby mode. Because the operational constraints, e.g. minimum permissible power and standby duration time, are fundamental for power plants, this flexibility provision capacity level can be difficult to be achieved.

Thanks to the large-scale deployment of DERs, the demand-side flexibility can be considered as an alternative resource to contribute to the system balancing task, especially at the local and regional level [14]. The potential can be even enlarged by leveraging a synergy from coupling sectors, including electrification in the transportation and building sectors, i.e. EVs and HPs, respectively. To realise the potential contribution of such flexibility resources to the system balancing, it is essential to develop smart control technologies and proper incentives. Otherwise, a large investment is needed for grid reinforcement to accommodate these emerging DERs.

## 2.2 Power quality

The uncertain nature of output powers of DERs gives rise to challenges in handling the voltage fluctuation, voltage unbalance and harmonics.

### 2.2.1 Voltage fluctuation

With the increasing share of DERs in a particular geographical area, the generated power can vary fast and considerably. This is due to sudden, simultaneous changes in solar irradiance (i.e. cloud passing) [15], subsequently provoking voltage fluctuation. Managing voltage fluctuation, thus, is a great concern for small DER systems. In some cases, the voltage fluctuation can be significant that interferes with the operation of voltage regulation equipment, such as load tap changer of distribution transformers, line voltage regulators and capacitor banks [3].

The LV distribution networks are predominantly constructed with radial topology, meaning that power flows from upstream to downstream networks to supply customers' consumption. The increasing use of EVs and HPs causes the voltage level in the distribution feeders to drop largely as more electrical loads will be added. The voltage drop will be severe towards the end of the feeder.

In contrast, a large scale of PVs eventually causes significant reverse power flows into the upstream networks; thus, the voltage rises along with the distribution feeders with the voltage level at the end of the feeder likely exceeding the permissible limit. Many European distribution system operators (DSOs) have reported the frequent occurrence of voltage rise problems due to the implementation of DERs in their LV networks [16]. This undesired voltage rise potentially damages the customers' electrical appliances. Furthermore, the voltage rise can lead to the generator tripping activated by internal protection. This subsequently induces the loss of the owners' revenue as they are not able to sell the surplus power generation. The level and widespread of voltage rise depend on the penetration level of PVs in the grid.

### 2.2.2 Voltage unbalance

Voltage unbalance is also perceived as a significant concern in the LV distribution network with high penetration of DERs. Voltage unbalance is quantified by a percentage term, called voltage unbalance factor (VUF), which is allowed to be within the acceptable range of 2%. This voltage issue arises from unbalanced system impedances, uneven distribution of single-phase loads and unbalance power generation from PVs. The intermittency of PV output powers can also lead to voltage unbalance. Moreover, voltage fluctuation can further deteriorate voltage unbalance. The use of EVs adds more stress on voltage unbalance [4]. Voltage unbalance increases at the end of the feeder. High level of voltage unbalance causes all induction motor type and distribution transformer to be overheated and de-rated. Subsequently, the lifetime of the equipment will be reduced. Addressing these challenges calls for the appropriate development of the grid-edge control, which is reviewed in the next sections.

### 2.2.3 Harmonics

Since power electronic interfaces of DERs feature nonlinear impedance to their generation source, they produce current harmonics which can be injected to the main grid [17]. Among DERs, PVs and wind generation (WG) are the major sources of current harmonic injection into the distribution networks [9]. Current harmonics, subsequently, create the voltage harmonics and total harmonic distortion (THD) [18]. These harmonics potentially become contributing factors for increased heating in the equipment and conductors, and

then power loss increase in the distribution networks [18]. Widespread adoption of DERs at the grid edges with power electronic interfaces results in a growing level of harmonics in power systems [17]. In this respect, harmonics grow into a major cause of power quality problems, which are critical issues in the distribution network associated with high penetration of PVs and WGs.

### 2.3 Network congestions

The appearances of EVs with increasing charging power can create the transformer congestions, either in LV or in MV networks [4, 20]. The congestions more likely occur when EV charging and HP operation activate concurrently, e.g. in the winter evening. A high amount of reserve power flows due to RES can also lead to transformer congestion. In this condition, reverse power flowing through the distribution transformer from RES located in its secondary side can exceed the rated power. Using the Monte Carlo approach, the study in [19] indicates the correlation between the voltage rise and reverse power flowing through the transformer due to high PV penetration, as demonstrated in Fig. 3. Therefore, voltage rise and transformer congestion issues become major barriers to further deployments of PVs. In practice, the limits on penetration level or peak power generation have been imposed on the integration of PVs in LV networks [15]. These approaches are, obviously, not desirable and should be replaced by alternative solutions, which are discussed in the next sections.

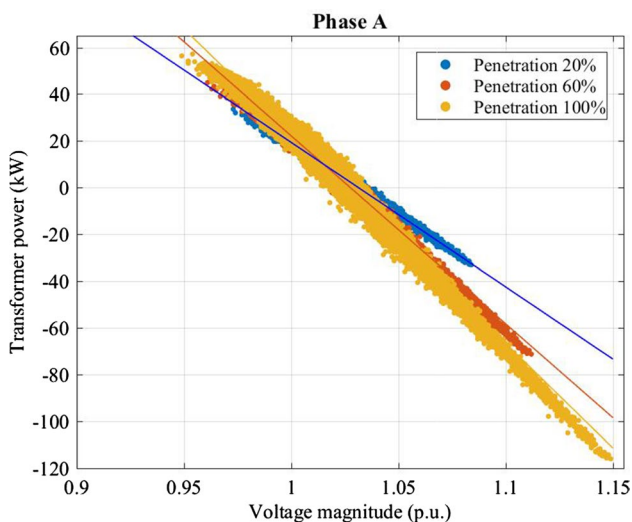

**Fig. 3** A scatter plot shows the correlation between transformer power flowing through phase A and voltage levels at a house connected to the same phase with different PV penetration. Negative transformer power depicts the reverse power flow due to PV power generation [19]

### 2.4 Stability issues

DERs connect to the grids using power electronic devices. More specifically, these devices are responsible for controlling power outputs and terminal voltage values, and converting DC voltage into AC voltage [2]. The usage of power electronic interfaces, therefore, is decisive to integrate DERs and shape smart power systems with the enhanced system dynamic performance [21]. However, this emerging application poses technical problems, i.e. harmonics and especially low or even no inertia.

These inverter-based DERs have no kinetic energy and spinning reserve [22], therefore providing no mechanical inertia response. In contrast, synchronous generators have kinetic energy stored in the rotors, which will be a quick inertia response to frequency instability in the systems. Such inertia response plays the most crucial role in frequency response, that effectively decreases the change rate of network frequency [23]. With decreasing share of such conventional generators due to the development of inverter-based ones, the hosting networks have low inertia and hence compromise frequency stability [24]. In practice, a steady reduction in the inertia response of the power systems has been being observed in the USA in correspondence with the growth of DER deployment [25]. Similarly, frequency violation problems have occurred more regularly in Nordic power networks, which are perceived as a significant correlation of increased DER integration [24]. In this context, the frequency stability emerges as one of the most significant concern. Recently, the inertia response has been mandatory for WGs in several countries, and this emerging application is being considered to PVs.

### 2.5 Changes in regulatory framework

The integration of DERs is radically altering the performance of the power distribution systems because these systems were not originally designed to accommodate such technologies. To facilitate this alteration while still effectively managing the network performance, DSOs must adjust the planning and operational procedures for the distribution networks with the presence of DERs. Additionally, the active, decentralised features of the future power distribution systems resulted from DER integration are not originally considered in the design of the business model of DSOs. Currently, DSOs are operating, maintaining and upgrading the distribution systems mostly in the passive fashion with fix remuneration specified annually by the regulators [1]. This passive manager of DSOs is inappropriate for the distribution systems, especially with the dynamic of DERs' outputs. Hence, along with the reconsideration of the planning and operation of the networks, DSOs' business model also needs to be modified to actively manage the grid [1].

On the other hand, DERs can provide the flexibility services for the grid operation as their production/consumption profiles can be controlled directly or indirectly by the owner/network operators. This flexibility, subsequently, can be utilised to handle the local issues, e.g. congestions/voltage violation. Also, this flexibility source, if properly aggregated, can support transmission networks. Using the flexibility of DERs, however, is currently limited due to the wide geographical dispersal of DERs [1]. Therefore, to effectively procure the flexibility of DERs, a new role in the form of the aggregators is essential to be introduced [1]. These aggregators should be empowered to have direct or indirect control over the flexibility of DERs, then offering a supporting tool for DSOs to address technical problems. To enable the introduction of the aggregator as well as the evolution of DSOs' business role, the radical change in the regulatory frameworks is required.

It is worth to mention that other issues are emerging in DER integration that includes frequency stability as indicated in [2, 18, 20, 22–24]. Additionally, the deployment of ICT at the grid edges imposes the challenges from the viewpoint of control and performance of the power systems by introducing cybersecurity and privacy threats [2, 6, 26]. However, this paper focuses on the issues related to the deployment of DERs.

### 3 Modelling and simulations of grid-edge control

Proper development of the grid-edge control has necessitated the modelling and simulations of DERs (focusing on PVs, EVs and HPs), which are firstly listed in Fig. 4 and subsequently presented in detail in this section.

#### 3.1 From physics-based to data-driven models

The physics-based models, also regarded as white box, include the physics of the object to be modelled, providing reliable and accurate modelling tools [27]. However, adequate knowledge of the system characteristics is required and then needs to be modelled in an adequate detailed manner. The model execution, consequently, shows the computational burden and is time-consuming. Typically, the

physics-based models are applied for component levels up to device levels [27]. For instance, the examples at device-level details for DERs, i.e. inverter modelling, are introduced in [28], while for component levels, the examples can be found in [29].

Data-driven models represent the statistical relationship between input and output data of a given system without presenting the underlying physics by using statistical and machine learning approaches. Thus, data-driven model execution is less computationally demanding [27] compared to physical-based models. Considering the increasing availability of data measurement, data-driven models are being employed more frequently, especially for system-level modelling. For instance, applying data-driven models at the levels of MGs is presented in [30]. Moreover, the data-driven models have been used at device-level details, such as in [27].

As highlighted in [31], the accuracy of the data-driven models is strictly related to the amount of training data available. In the attempt to overcome this issue, online auto-adaptive parameter identification methodologies have been developed. The basic idea of these methods is to adjust, in the real time, the model parameters whenever something occurs on the physical system by changing its internal parameters to keep its output as close as possible to that of the physical system. In doing this, they are capable to capture any change in the internal parameters of the physical system. Model parameters are identified adopting algorithms based on the recursive least squares [32], Lyapunov theorem involved in the sensitivity theory [33, 34] and genetic algorithm [35].

#### 3.2 From numerical to real-time simulation

A simulation platform to enable the grid-edge control solutions, especially for MG applications, can be implemented using either numerical simulation or real-time (RT) simulation approaches. The first approach, i.e. non-RT, is widely used in the early stage, e.g. design, due to ease of implementation, low cost and safety reasons, using simulation software. Several common simulation software applications include MATLAB/Simulink, PSCAD, GAMS and HOMER [36]. Subsequently, the second approach is used in the next stages, e.g. validation, to further test the proposed works beyond the numerical simulation for solutions before real deployment. In this platform, the RT simulator machine takes the central role as its powerful simulation capability enables the modelled MG to operate closely to realistic manner [37]. RT simulators can be of great help for designers and researches to better understand the main problems related to MG development and to identify the more appropriate solutions. The commonly used RT simulators include RTDS and Opal-RT. Some laboratory-based setup and test beds for RT MG simulation platforms have been developed

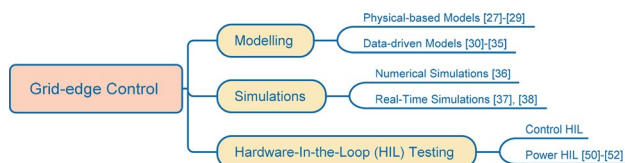

Fig. 4 Types of modelling and simulations of the grid-edge control

in various countries, e.g. Austria, Germany, France and the UK, as discussed in [37, 38].

However, it is worth noting that these simulators may not be accurate enough because, as pointed out in [39], the models on which they are based are not always capable of replicating the realistic behaviour of the physical system. As a consequence, the solutions identified by these simulators may be inefficient when applied to the actual system. For this reason, it is necessary to test these solutions in the real world to assess their actual impact on the MGs. To comply with this exigency, several MGs have been developed all over the world [40, 41]. The survey of these systems presented in [39–41] pointed out that there exist different kinds of MG test beds that can be grouped into four categories. The first of these includes MGs operating in a grid-connected mode such as those referred to in [42]. Thanks to this feature, they provide a useful test bed to assess impacts arising from their integration into the distribution grid and to evaluate the optimal technical and operational solutions for mitigating them. The second category refers to isolated MGs such as those in [43, 44] that can be usefully adopted to develop control strategies able to ensure the economical, reliable and secure operation of these systems without taking advantage of the main grid support. The third category is related to those MGs that can be operated in both grid-connected and isolated mode, and thus they enable MG operators and researchers to investigate on their sensitiveness to severe perturbations such as the sudden loss of the main grid [46]. The results of these analyses can be used to identify the more suitable control actions for ensuring the survival of such systems during their transitions from one state to another. Finally, the MGs in the fourth category are those capable of operating in all MG operating modes and transition states [47, 48]. These MG test beds provide a powerful solution enabling researchers to develop and to test complex solutions for ensuring the economical, reliable and secure operation of the MG in all operating states and transitions.

### 3.3 Hardware-in-the-loop testing

Hardware-in-the-loop (HIL) allows to test and validate the prototype of equipment interacting with a simulated system under various realistic operating conditions [49]. HIL testing can be classified as control HIL (CHIL) and power HIL (PHIL). The former refers to the testing method for a controller prototype. The latter refers to the method for a device, e.g. PV power converters, through a power amplifier [50–52]. Because the control algorithms for DERs will be thoroughly discussed in the next sections, PHIL testing is presented in this section.

Figure 5 shows an example of real-time PHIL testing for commercial PV inverters. A test grid is simulated in a real-time simulator, and every time step, typically in a range

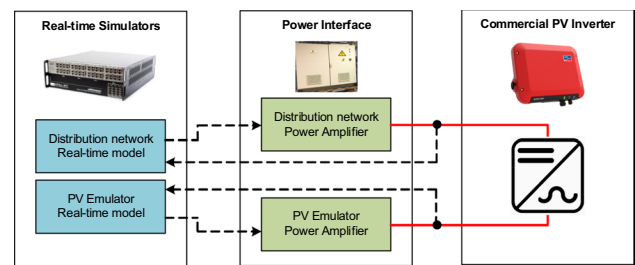

**Fig. 5** Example of a PHIL setup used for the tests of a PV inverter. The red lines represent power flow, while the dashed black lines represent data/measurement flow

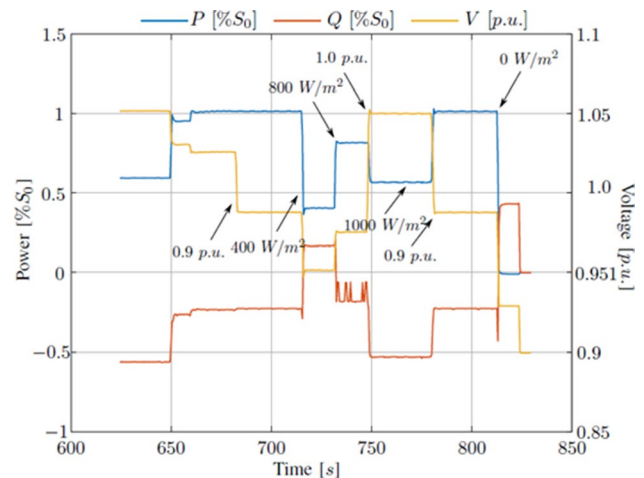

**Fig. 6** Active and reactive power outputs (compared with the apparent power) of a real PV inverter in response to changes in voltage levels (in p.u.) at POC in PHIL test [45]

of 50  $\mu$ s, it computes the current grid status. The status (voltage or current) of the point of connection (POC) of the PV inverter is sent to the power interface with the task to replicate it in the hardware side dynamically. Following this, the PV system variables are read by the hardware measurement system and fed back to the real-time simulator. To demonstrate these test outcomes, Fig. 6 illustrates the performance of the PV inverters using the PHIL setup, as reported in [45]. The test results show that the inverter operates as expected, in which its reactive power absorption increases, while active power generation decreases to solve the voltage rise issue at the POC. This is a so-called droop control method, which will be described in the next section.

Different interface methodologies and algorithms have been proposed for interfacing the hardware and software part, also depending on the power interface technology. A review has been performed in [52], and it can be summarised with an interface type and power interface technology.

### 3.3.1 Interface type

For the voltage type, the voltage of the point of common coupling (PCC) is supplied to the power interface, while the current measurement of the DER is fed back to the simulator. DER is represented by a current source, that is particularly useful for grid-feeding converters [53, 54].

For the current type, the current of the PCC is supplied to the power interface, while the voltage measurement of the DER is fed back to the simulator. The simulated DER is represented by a voltage source, which is particularly indicated for grid-forming converters, such as smart transformers [55].

### 3.3.2 Power interface technology

For synchronous generator, this is a high-power/voltage and low-cost power interface solution. Due to the reduced dynamics, depending on electro-mechanical variables, only slower power system phenomena can be accurately represented (< 10 Hz).

For switching element power amplifier, this is a high-power/low-to-medium-voltage interface solution. It recurs to semiconductor-based technologies, such as IGBT or SiC, and it allows to represent the majority of the desired dynamics (up to few kHz) and bidirectional power flow. It may introduce delays in the loop up to a few hundreds of microseconds, affecting the PHIL system stability and accuracy.

For linear power amplifier, this is a low-to-medium-power/high-cost interface solution. Due to the analogue switching, it can reach tens or hundreds of kHz bandwidth, allowing electromagnetic testing with high accuracy. Furthermore, it introduces a limited delay in the testing (a few microseconds), increasing the PHIL stability margin.

In the last years, the PHIL validation has been chosen as a method to assess the performance of DERs, and smart grid in general, in realistic grid conditions [53, 56]. In [54], the PHIL testing of a 500 kW photovoltaic converter has been performed. A new control strategy for maximising the power extraction from PV plants under low solar irradiation has

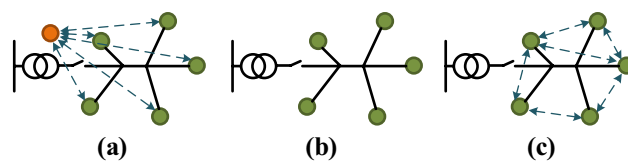

**Fig. 8** Classification of grid-edge control strategies based on their communication network: **a** centralised control, **b** decentralised control, **c** distributed control. The green circles represent DERs, while the orange circle represents a central controller. The dashed blue lines represent two-way communication links

been proposed and validated with PHIL in [57]. The 60 kW 3.6kWh high-speed flywheel performance in providing frequency support services has been assessed in [58]. Besides, motor drives have been of interest of PHIL, particularly for high-power (< 1MVA) testing [59], or marine systems [60]. All the previous examples involved the use of a voltage-type interface. Fewer applications have been found employing a current-type interface. As an example, the smart transformer, a power electronics-based transformer, has been extensively tested in [61] for the provision of frequency support services.

## 4 Grid-edge control architectures, layers and strategies

This section describes different architectures, layers and strategies for the grid-edge control with a summary being shown in Fig. 7. Possible grid-edge control solutions, which are based on the coexistence of MGs and the distribution grids, are also presented.

### 4.1 Control architectures

Based on the communication network, the grid-edge control strategies can be categorised into centralised, distributed and decentralised control, as shown in Fig. 8.

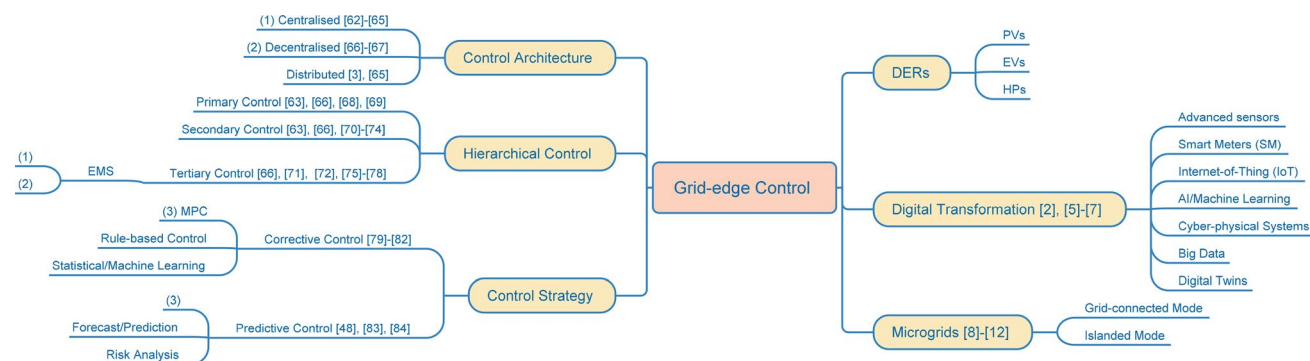

**Fig. 7** Summary of the grid-edge control architectures, layers and strategies discussed in this paper

### 4.1.1 Centralised control

This control method (Fig. 8a) is considered as a conventional approach, constituted of a central controller and bidirectional communication links between this unit to every single component of the networks. Theoretically, the central controller needs to receive and process the messages exchanged from all units, causing a large number of message exchanges within the grid. All control decisions are made by the central controller. This control architecture makes the system development expensive [38] while weakening the system reliability due to a single-point-of-failure of the central controller or the malfunction of any communication links [62, 63]. Scalability is another shortcoming of the centralised control, resulted from the additional complexity to the communication network and required setting update of the central controller. With the high integration of DERs, centralised control is potentially impractical [64]. Instead, the adoption of centralised control is appropriate for a small-scale grid that includes a small number of nodes and does not require frequent system expansion [65]. Using the energy management system (EMS) is a promising solution to the implementation of centralised control.

### 4.1.2 Decentralised control

The decentralised control (Fig. 8b) dismisses the duties of a central controller nor one-to-all communication system, thus allowing simplicity and relatively low cost of implementation, and obtaining higher reliability. As no extensive communication infrastructure is required, the required investment can be kept at a minimum. The control decisions are made individually at each DER by its local controller using the local information [66]. This method makes ICT performance robust against the failures. However, DERs lack the awareness of system-wide performance as well as other units' status [21]. Moreover, these methods usually apply the same control settings for all DERs, which have different types and operating conditions [67]. This approach can lead to uncooperative operation of DERs, subsequently unexpected problems [67].

### 4.1.3 Distributed control

In the distributed control (Fig. 8c), a central controller is excluded, but communication is needed, which is in the form of sparse communication links between some adjacent DER units with low bandwidth. This kind of communication allows developing the distributed control with lower cost compared with the centralised control [62]. By using the sparse communication, all DER units take the responsibilities for the network optimisation and stability via coordinating each other. In case of a new DER installed, only

the configuration for the communication links between this unit and the neighbouring ones is required [3]. Distributed control is suitable for a system that has a large number of nodes, high complexity of system structure and more frequent expansion of the system [65].

## 4.2 Hierarchical control

Because the distribution networks compose different power generation systems based on different technologies and power ratings, it is necessary to implement a hierarchical control to maximise the controllability, reliability, efficiency while minimising the operation cost [10]. The hierarchical control, thus, can assist the robust operation of the networks. Determination of optimum operation for the grid takes into account various factors, for example, rated and available capacity of generation systems, distribution of loads and generation systems, electrical market prices and generation costs. In that sense, neither fully centralised nor fully decentralised control can accomplish the proper control of the system. A compromise between fully centralised and decentralised control can be obtained employing a hierarchical control [66]. The hierarchical control can be formulated by three main layers: primary, secondary and tertiary control. These control layers are different in their: timeframe and response speed when they are operating, and the supporting infrastructure requirement [66].

### 4.2.1 Primary control

Primary control is the first level of hierarchical control. It is implemented by local controllers, which are embedded in each component, such as RES, EES and loads. This control layer is capable of acting fast (on the order of milliseconds) in a predetermined way without needs for communication with neighbouring units [68], contributing to the enhancement of network stability [69]. The functions of the primary control are islanding detection, output control of individual DERs and power-sharing among DERs [63, 66]. This control layer, consequently, enables the inverters to autonomously operate at each unit, resulting in the improvement in power stability.

### 4.2.2 Secondary control

Secondary control is upstream control layer of the primary control that is responsible for the reliable, secure and economical operation of the grid [66]. This control layer provides the reference parameters for the primary control, e.g. output power or voltage at the POC [63, 70, 71]. Therefore, the secondary control eliminates the steady-state error caused by primary control [66, 72]. For example, secondary control restores grid frequency and voltage amplitude



within the accepted range, e.g. by  $\pm 0.1$  Hz in Nordel (North of Europe) or  $\pm 0.2$  Hz in UCTE (Continental Europe) [73], as well as voltage unbalance and harmonic compensation. Besides, it is in charge of synchronisation and power exchange with the main grid [14]. The response speed of the secondary control is slower than the primary due to some limitations, such as availability and capacity of primary sources.

The approach to design secondary control can be classified as centralised, decentralised and distributed control architecture [74] as discussed in Sect. 4.1. The centralised one is suitable for the network operating in an islanded mode in which supply–demand balance is a critical issue [66]. The decentralised and distributed ones are suitable for the network operating in a grid-connected mode in which multiple objectives exist. Communication network plays a crucial role as secondary control gathers information from a primary control within each DERs and, in return, dispatches control signal to the primary control [63]. However, after the secondary control, the grid may not operate at the optimal point.

#### 4.2.3 Tertiary control

Tertiary control is the top control layer which optimises the power flow in the grid once the grid already operates at its rated frequency and acceptable voltage range [72]. Awareness of operation conditions of neighbouring and upstream distribution grids is essential to execute the optimisation functions, in which ICT is a key enabling technology. This optimisation considers the relationship between the demand and the energy supply balance, and the marginal generation cost of each DER. The tertiary control regulates the power flows between the main grid and the controlled grid. Additionally, such control level also takes charge of restoring the secondary control reserve and supporting the secondary control is necessary [71]. Tertiary control works in the time frame of several minutes, issuing the control command to secondary controls within a grid [66].

As an example of tertiary control for MGs, EMS, that is equipped with an effective and optimal control strategy, can properly control MGs and then improve the distribution grid performance [75]. The main responsibilities of an EMS are to assign generation references to dispatchable distributed generations (DGs) and manage controllable loads to control the power production and energy consumption in an MG [3]. Many studies of EMS of MGs have been conducted with the centralised control architecture in which a centralised controller is the most critical part. Recently, the studies of EMS of MGs come up with the idea of applying a distributed control scheme as it is conceived to be less complex and more robust than the centralised one [76]. Typically, the MG components are equipped with advanced subsystems and control algorithm that allow them to make the decision

themselves for their performance. Communication and computation capability again play an essential part in distributed control-based EMS. However, the above-mentioned capabilities of MG components allow less message exchanged within MGs and then minimise the requirement of the communication and computation capabilities [76]. In that sense, the multi-agent system (MAS) architecture is suitable for the distributed control-based EMS. The optimal control techniques for MG EMS can be classified concerning cost function objective and optimisation methods [77], in which the former consists of energy dispatch, carbon dioxide emission, optimal power flow and load shedding. The latter consists of predictive optimisation, mixed-integer linear programming, game theory, particle swarm and nonlinear programming. On the other hand, many studies focus on a computational method for EMS of MGs, for example, decentralised robust servomechanism problem (DRSP) [78], genetic algorithm, fuzzy logic, particle swarm optimization (PSO) and neural network.

### 4.3 Possible grid-edge control strategies

To enable potential from the grid-edge control, it is important to consider the coexistence of the control structures from the distribution grid, the (grid-connected) MG, down to available local control functions of individual DERs. This synergy from all control layers can be realised from either corrective or predictive control approach, which will be discussed in the followings.

#### 4.3.1 Corrective control

Corrective controls refer to control actions to mitigate or reduce the potential impacts of the undesirable operational situations when they occur, aiming to maintain the system with normal operation. Within the distribution network context, the undesirable operational situations include voltage limit violation, power quality issues, congestions and faults in the network. Implementation of corrective controls can be based on rule-based methods, model predictive control (MPC) and statistical/machine learning techniques. Examples of corrective controls for DERs consist of control of power outputs of PVs and EVs for voltage regulation [79, 80]; reduction in HPs' power consumption for congestion management [81]; and fault-tolerant control of WGs to achieve ride through capability [82].

#### 4.3.2 Preventative control

Preventative controls are designed to carry out before corrective controls, i.e. when the threat events have not occurred. The purpose of preventative controls is to prevent the likelihood of such threat events or non-conformities in the system,

then avoiding their potential impacts. To this end, preventative controls typically adopt the forecast/prediction techniques and risk analysis for a specific time horizon in future. MPC can also be used to realise the preventative control algorithm. Examples of the applications in MGs with the high integration of DERs using preventative controls include optimal operational planning/scheduling of EVs [48]; power ramp-rate control of PVs using forecasting methods [83]; and MPC-based control of ESS to reduce the fluctuating power outputs of PVs [84].

## 5 Particular use-cases for grid-edge control

In this section, the review of some particular use-cases for the grid-edge control, focusing on PVs, EVs and HPs, is described as they are the main pillars of the grid-edge control.

### 5.1 Autonomous control

Autonomous control for DERs, also called local control, provides voltage and frequency control of the regional LV network in the islanded operation mode, and the support services for the regional LV network in the grid-connected mode (e.g. voltage regulation support) [85]. Furthermore, this control supports the elimination of voltage and frequency deviation during the transition from the grid-connected operation mode to the islanded operation mode and vice versa [85]. The control actions are implemented at the electronic inverters interfacing the sources with the grid and involve the local measurement of frequency and voltage only; no information exchange with surrounding sources needed. Figure 9 summarises the main use-cases for autonomous control at the grid edge.

#### 5.1.1 Active power control

Controlling active power injection from RES is perceived as the most effective solution to address their negative effect on the grid operation due to the fluctuating power production. This means that RES must be capable of controlling

its active power output upon the request, e.g. to respond to voltage rise problems, instead of solely maximising the energy harvesting. The active power control of RES can be categorised into two main groups: power reduction control (PRC) and power ramp-rate control (PRRC). In the PRC, the actual power output of RES is reduced from the instantaneous available power to a specified level, which can be fixed or variable during the operation period [86]. In the PRRC, the rate of change of RES power output is limited to a certain value during the fluctuation of the primary renewable resources (e.g. passing clouds) [86]. This control decreases the power fluctuation of RES, subsequently stimulating the reduction in the network voltage fluctuation. Possible approaches to fulfil these active power control functionalities for DERs can be based on ESS, control of PV inverters and local controllable loads [87]. Meanwhile, provision of the power reference values and supervision of the active power control for DERs can be made by using the droop control, or auto-adaptive control, or data-driven methods.

#### Control of ESS

In [88–93], ESS is combined with the PV system in the distribution grids to realise the PRC for mitigating the voltage fluctuation problems due to high penetration of PVs. Furthermore, during the unavailability of power generated from PVs (e.g. during the nights), the ESS can inject active power into the grid, contributing to the voltage support and congestion management during peak load periods. Authors in [94, 95] proposed the integration of ESS into PV systems to implement the PRRC for the PV power fluctuation reduction. The combination of ESS and RES offers a promising solution to effectively control RES power because of its high flexibility. Meanwhile, maximising the energy harvesting of RES will be imperious. However, the cost associated with the installation, operation and maintenance of that system is the main concern. Authors in [80] proposed the use of EV batteries as ESS to deliver the PRC for residential PV units.

#### Control of PV inverters

Without ESS, active power control of PVs can be carried out to address the technical issues arisen by their significant development. In [79, 80, 96], the maximum

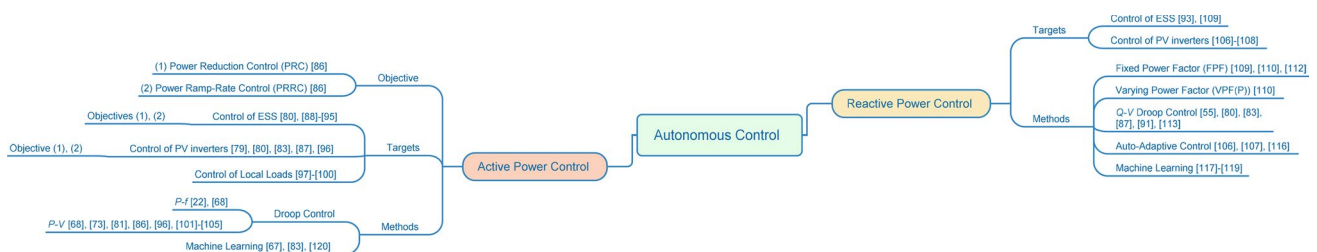

Fig. 9 Summary of use-cases for autonomous control at the grid edge

power point tracking (MPPT) algorithm embedded in the power converter of PV systems is modified to realise the PRC supporting the voltage rise alleviation. Authors in [83] introduced the modification of MPPT in PV inverters to provide the PRRC without energy storage. Controlling PV power converters requires no additional hardware component, making it cost-effective to regulate PV power. The main drawback of this method is the loss of energy yield due to the power curtailment and the impossibility of injecting extra power to the network [87].

*Control of local load*

Alternatively, the controllable local loads can be adjusted to consume the power produced from PV systems; thus, PV power output requirement will be satisfied [87]. In this context, HPs are regarded as the most effective one among the controllable loads. A method of HP control to solve for voltage rise resulted from high PV generation is introduced in [97]. In [98], HPs are controlled in a coordinated way with ESS to suppress frequency and voltage fluctuation. A rule-based control is applied for HPs to maximise PV self-consumption by converting surplus PV generation into heat and storing in thermal energy storage as proposed in [99, 100]. Because the operation of MPPT is not affected, PV inverters are still able to inject maximum available power, which is the main benefit of this approach. Nonetheless, this approach relies upon the coincidence of the load and PV availability.

*P-f and P-V droop control*

*P-f* droop control, also known as conventional droop control, mimics the behaviour of synchronous generators, which reduces the frequency when active power increases [22, 68]. This behaviour can be stimulated by the following formula:

$$f - f_o = -k_p \cdot (P - P_o)$$

where  $f - f_o$  represents the grid frequency from the nominal value,  $P - P_o$  is the variation of output active delivered by the power converter to compensate such deviation, and  $k_p$  are the droop slope. The *P-f* droop control is suitable for the inductive grid, such as high-voltage and medium-voltage network.

*P-V* droop control, on the other hand, is widely used to provide the power reference values and supervise the PRC of DERs in LV networks as presented in [68, 73, 81, 86, 96, 101–105]. The control principle can be represented as:

$$V - V_o = -k_p \cdot (P - P_o)$$

where  $V - V_o$  represents the voltage level deviation [97] from their rated values. For demonstration, a typical *P-V* droop control applied for PV systems is shown in Fig. 10.

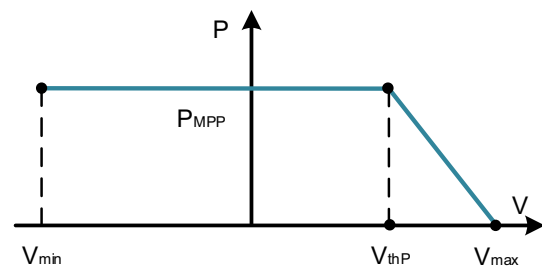

**Fig. 10** *P-V* droop control for PV inverters.  $V_{thP}$  denotes the voltage threshold.  $[V_{min} V_{max}]$  is the acceptable voltage range

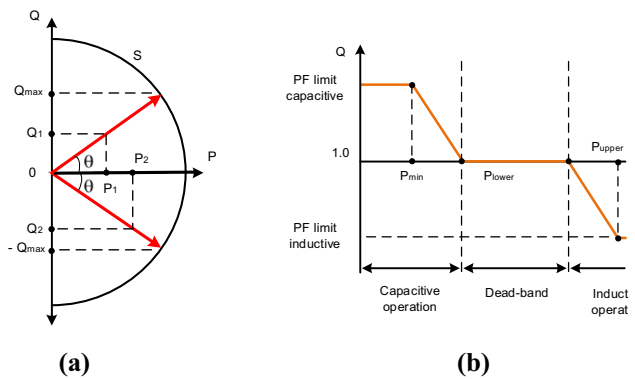

**Fig. 11** **a** Operation regions for PV inverters in FPF method and **b** VPF(*P*) method for reactive power control. PF being prescribed to be  $\cos(\theta)$ .  $[P_{lower} P_{upper}]$  are the dead-band interval,  $P_{min}$  and  $P_{max}$  are the threshold active power levels for capacitive and inductive PF, respectively

**5.1.2 Reactive power control**

With high penetration of DERs, there is growing interest in using these technologies as distributed reactive power resources for voltage/VAr support. It is technically viable since the DERs use the advanced power electronic interfaces, where active and reactive power exchange to the grid can be adjusted separately. Hence, the reactive power support can be provided from ESS and PV systems. Controlling the reactive power of PV inverters for VAr support has been proposed in [106–108]. Approaches to coordinate ESS and reactive power control of PV systems are proposed in [93, 109].

There are various strategies to generate the reactive power output references, including fixed power factor (FPF), varying power factor in terms of active power generation (VPF(*P*)) and reactive power responding to the voltage level (*Q-V* droop control) [110] and auto-adaptive control. Figure 11 demonstrates the reactive power operating points of the DERs power converters using these various strategies. Specially for PV inverters, the analysis of these reactive power control strategies can be found in [111].

(a) Fixed power factor (FPF)

Fixed power factor (FPF) method regulates the reactive power output of the inverters ( $Q_{inv}$ ) as a fixed proportion of active power outputs at  $t$  time instant as described by:

$$Q_{inv(t)} = \tan [\arcsos(PF)] \cdot P_{inv(t)}$$

where PF is the power factor which is predefined as a fixed parameter. The set of reactive power operating points is represented as the red diagonal lines in Fig. 11a. Given predefined PF, the operating points of  $Q_{inv}$  stay along the red diagonal line and rely upon only  $P_{inv}$  in a linear manner. In [109, 112], PV inverters operate with FPF to provide reactive power support, while ESS stores active power generation from PV systems during voltage rise conditions. This combination aims to avoid active power curtailment of PV systems.

Although this method is simple and reliable, it has a major drawback. In case of a low level of  $P_{inv}$ , the probability of voltage rises and low voltage at POC of the inverters is low. Consequently, the reactive power output of the inverters is not desired because it leads to additional losses in the network. Applying the FPF method in such condition, therefore, will not be beneficial [110]. This negative consequence can be avoided by applying the VPF( $P$ ) method.

(b) Varying power factor (VPF( $P$ ))

In VPF( $P$ ) method, the PF is varying according to injected  $P_{inv}$  of the inverters. Consequently, the controlled  $Q_{inv}$  can be defined using the modified equation below:

$$Q_{inv(t)} = \tan [\arcsos (PF_{(t)})] \cdot P_{inv(t)}$$

where  $PF_{(t)}$  is the power factor set point in correspondence with  $P_{inv}$  at  $t$  time instant. Figure 11b presents the VPF( $P$ ) method. When  $P_{inv}$  is still in the dead-band interval, the inverter operates with unity power factor (PF= 1.0) and no reactive power injection or absorption is required. As soon as injected  $P_{inv}$  is greater than  $P_{max}$ , PF decreases from unity PF to limit inductive PF, allowing the PV inverter to absorb reactive power from the grid. On the other hand, when injected  $P_{inv}$  is lower than  $P_{min}$ , PF inductive part of the curve is in operation when the overvoltage occurs due to the surplus active power supply, which necessitates the reactive power absorption [110], whilst the capacitive part of the curve is operational as the under-voltage appears resulted from the low active power supply, which requires reactive power generation.

(c)  $Q$ - $V$  droop control

Compared to FPF and VPF( $P$ ),  $Q$ - $V$  droop control method provides more flexibility when controlling reactive power for supporting the voltage regulation [106].  $Q$ - $V$  droop control directly utilises the voltage measurements for regulating reactive power output of the inverter

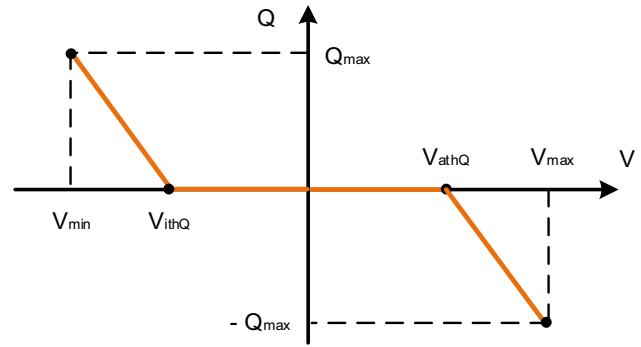

Fig. 12  $Q$ - $V$  droop control for PV inverters.  $V_{ithQ}$  and  $V_{athQ}$  denote the voltage threshold for power injection and absorption, respectively.  $[V_{min} V_{max}]$  is the voltage acceptable range.  $Q_{max}$  denotes the maximum reactive power that can be generated or consumed by the inverter

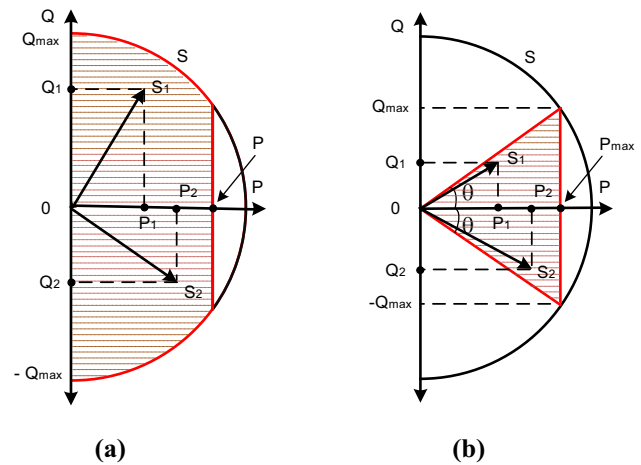

Fig. 13 Operation regions for PV inverters demonstrated by the dash-line regions for two control strategies: **a** without minimum allowed PF requirement and **b** with the minimum allowed PF requirement

as demonstrated in Fig. 12. Reactive power capacity of the inverters is restricted by the apparent power rating of the inverter and  $P_{inv}$  generating at a given irradiance. Also, reactive power capacity will be further defined if the requirement of the minimum allowed PF is applied. To illustrate this, the operating region for reactive power in the  $Q$ - $V$  method is shown in Fig. 13 for two cases with and without minimum allowed PF requirements. In [55, 80, 83, 87, 91, 113], PV inverters operate with  $Q$ - $V$  droop control to reduce voltage rise problems due to surplus PV power generation. Nevertheless, reactive power control by itself can be efficient to mitigate voltage rise problems due to the high  $R/X$  ratios in LV distribution networks and the limited reactive power capacity of the PV inverters [4]. Thus, the combination of reactive and active power control is applied as discussed in [62, 74, 105, 112, 114, 115].

(d) Auto-Adaptive Control

Fuzzy logic can be employed to generate the reactive power output references for the inverters, forming the auto-adaptive control [106, 116]. While the typical  $Q-V$  droop control has constant droop coefficients, the auto-adaptive control has the coefficients that are variable according to the operational conditions of the inverters [106]. In [107], the auto-adaptive control for voltage regulation support is performed in real PV inverters and then further tested in a real LV distribution system.

5.1.3 Data-driven/machine learning approaches

The digital transformation at the grid edge provokes the development of data-driven/machine learning approaches using real data measurements to support the network operation. The authors in [67] introduce machine learning approaches based on support vector machines to optimise the local control design of DGs, loads and ESS. The optimised local control performs reactive power control and active power curtailment without the needs for communications. In [83], data measured by the sensors in a PV system are used to forecast the output power, which is then used as an input for the PRRC of PV systems to reduce voltage fluctuation due to could passing. A data-driven method presented in [117] adopts nonlinear control techniques to determine the reference values for real-time reactive power outputs of inverter-based DGs. The machine learning methods proposed in [118, 119] employ multi-learning regression to calculate the optimal reactive power outputs of DGs. In [120], a voltage control approach at the grid edges is proposed using an artificial neural network (ANN) for DER inverters.

5.2 Coordinated control of DERs

Since DERs are increasingly connected to the distribution networks, the coordinated control is important to effectively exploit these resources for the system operation support. The

coordinated control can be considered as an upper layer of autonomous control with the use of the ICT infrastructure and coordinated control algorithms. Figure 14 shows a summary of the main use-cases for coordinated control at the grid edge.

5.2.1 Optimisation method

The optimisation method tunes the autonomous control of DERs by periodically providing the set points of active and reactive power of DERs for the optimal uses. For this method, the operational information of all DER unit must be collected. The nonlinear optimisation is discussed in [106] to solve multi-objective functions of minimising network losses, voltage level deviation and transformer tap changing. Linear programming is used in [92] to optimise the power threshold levels, which trigger the ESS charging to enable PRC of PV systems during their peak generation. In [99], cost optimal control is proposed to maximise PV self-consumption by operating HPs. In [96, 106], centralised optimisation approach is employed to optimally coordinate reactive and active power of PV systems for voltage rise mitigation with reduced active power curtailment. Similarly, the centralised optimisation method is used in [81] to coordinate HPs for congestion management in LV networks. Authors in [114] formulated the optimal tuning of autonomous control, including active and reactive power, of PV units as a convex optimisation problem solved by a central controller. In [121], the optimisation of PV systems and EVs is also formulated as a convex optimisation problem but solved in a distributed manner.

5.2.2 Consensus method

Consensus algorithms have been widely used as a basis for distributed control. In this concept, each DER system communicates and shares its local information as the variable of interest with adjacent ones using a distributed procedure [36]. The objective function of the consensus algorithm is

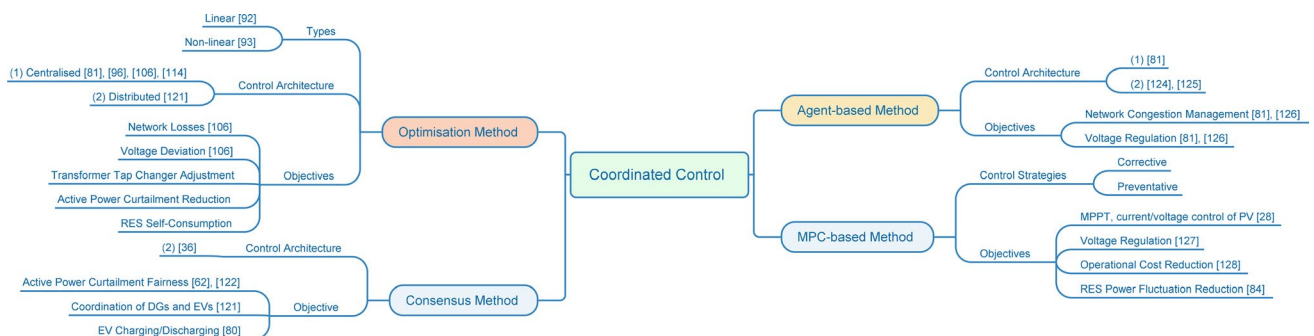

Fig. 14 Summary of use-cases for coordinated control at the grid edge

to converge all DERs to a common agreement after an iterative process. The variable of interest can be regarded as a quantity that is agreed by all DER systems. Authors in [62] applied the consensus algorithm to PV inverters to achieve fair active power curtailment for voltage rise mitigation. The coordinated charging/discharging control of EVs for voltage regulation based on the consensus method is presented in [80]. In [121], the consensus method is employed to coordinate the active and reactive power output of renewable-based DGs and EVs. The method in [122] utilises consensus-based distributed control to obtain fair generation curtailment of PV systems. In [123], consensus protocols are used in combination with fuzzy logic to tackle voltage regulation problems.

### 5.2.3 Agent-based method

Another method to coordinate various DERs for their control and management in the distribution networks is to use the MAS approach [21]. In the networks, DERs can be represented by individual agents that have a certain level of autonomy and communication capability. Authors in [81] developed a MAS-based control strategy to coordinate the process of a unified approach for managing thermal and voltage violation problems. Compared with the centralised scheme, the proposed MAS approach requires decreased communication and computational power due to the lower amount of exchanged information. In [124, 125], peer-to-peer control of networked MGs based on MAS technique has been proposed. The control architecture is distributed and contains three control layers (i.e. primary, secondary and tertiary) operated in the agent of each MG. MAS market-based control for charging fleets of EVs is proposed in [126] with transformer congestions and voltage violation issues being considered.

### 5.2.4 MPC-based method

As described in previous sections, the MPC-based method can be utilised to implement the corrective and preventative control. MPC method is a discrete-time control scheme, in which at each time step, the future control sequence is determined for a finite time horizon. In [28], MPC-based techniques are used to realise the basic control functionalities of PV power converters, such as MPPT, current and voltage control. MPC-based control of ESS to reduce the PV power fluctuation of PVs is discussed in [84]. The authors in [127] adopted MPC to define optimal setpoints for active and reactive power of DGs and transformer load tap changer for voltage regulation. In [128], MPC is used to schedule HPs aiming to reduce its operation cost by preheating the houses during peak hours with low TOU electricity price or high PV power outputs.

Table 1 summarises the main review of some particular use-cases for the grid-edge control discussed in this section.

## 6 Future trends

### 6.1 Advanced functionalities of DERs

With more installation in distribution networks, DERs are increasingly expected to provide more support with the network control and operation using advanced functionalities. The expected functionalities include virtual inertia [24], Volt/VAr support, frequency regulation, harmonic compensation and dynamic grid support (fault-ride-through capability) [129]. To realise these functionalities, the existing network operating standards for DER systems are suggested to be reinvestigated and appropriately adjusted.

**Table 1** Summary of main review of particular use-cases for grid-edge control

Particular use-cases for grid-edge control	Applications	Benefits	Drawbacks
Autonomous control of DERs	Voltage/frequency control in islanded mode	Rapid, robust control of DERs in an autonomous manner, contributing to the enhancement of network stability	Lack awareness and coordination of system-wide performance
Active power control	Network operation support services in grid-connected	Easy-to-use and a plug-and-play solution	Optimising network operation is not achieved
Reactive power control	Eliminate voltage/frequency deviation during the transition from grid-connected to islanded	No needs for extensive communications	
Coordinated control of DERs	Periodically tune autonomous control (i.e. providing setpoints)	Leverage the capacity and controllability of DERs to support the optimal network operation	Bidirectional communications are needed, increasing investment and operation costs
Optimisation method	Multi-objective optimisation of the network performance	Facilitate further deployment of RES in the network	The control efficiency highly depends on the performance of the communication systems
Agent-based method	Solve operational challenges due to high DER penetration		
MPC-based method			

## 6.2 Distribution network monitoring improvement

The presence of DERs increases the complexity of the distribution network control and performance. Therefore, it is important to properly control these resources as well as the network to ensure the reliability of the power supply. On the other hand, the digital transformation at the grid edge brings opportunities to increase the observability of the grids by using data measurement. These two aspects highlight the needs to improve the network monitoring leveraged by the digital transformation at the grid edges.

## 6.3 Cybersecurity consideration

The digital transformation at the grid edges expands ICT system and increases the information exchange, which imposes the challenges from the viewpoint of control and performance of the power systems by introducing cybersecurity and privacy threats. The cyber-attacks can be carried out by a living person, or malicious software, or the systems' resources [6], inducing the interruption of the communication services and then the electricity provision and also harm to end-users privacy. Hence, it is suggested to investigate the impact of cyber-attack on the operation of DERs and the networks.

## 6.4 Regulatory/Framework consideration

It is increasingly important to not only promote DER integration in the grid but also effectively exploit their controllability to support grid performance. Apart from technical aspects, attention is required for reconsidering the existing regulatory/framework about the DSOs' business model as well as new roles in the form of the aggregators [1]. The local flexibility market, moreover, is suggested to be implemented to enable the efficient procurement of flexibility available from DERs [1].

## 6.5 Uses of data-driven/machine learning approaches

The increasing availability of data resulted from the digital transformation at the grid edges has motivated the application of data-driven/machine learning approaches. These applications can be associated with network planning, monitoring, controlling and operation. Besides, the data-driven/machine learning approaches can be used as tools for data governance. With the widespread of digital transformation at the grid edges, it is expected that data measurement in distribution networks will be growing spectacularly. This calls for new processes of managing and exploiting the data effectively. Furthermore, as data-driven/machine learning approaches can be applied without the system modelling,

the applications of these approaches can be replicated better and easier than the conventional control methods, such as master–slave or cloud-edge structure.

## 7 Conclusion

A comprehensive overview of the grid-edge control, i.e. the control of DERs leveraged by the digital transformation at the grid edges, is presented in this paper. Despite many benefits, the increasing integration of DERs with its intermittent and unpredictable nature and uses of power electronic interface creates challenges in maintaining the network power quality and stability. Hence, a new paradigm of DERs' control and operation strategy is required to effectively manage the LV distribution networks. This new paradigm calls for data-driven methods to capture uncertainty and complexity natures of DERs, while the coexistence between the grid and DERs/MG control strategies is important to be adopted. If properly implemented, this new paradigm can effectively leverage the inherent controllability of DERs and the availability of the digital transformation at the grid edges. As a result, the new paradigm can allow the opportunities to outweigh the challenges introduced by high penetration of DERs to the LV distribution network operation.

**Open Access** This article is licensed under a Creative Commons Attribution 4.0 International License, which permits use, sharing, adaptation, distribution and reproduction in any medium or format, as long as you give appropriate credit to the original author(s) and the source, provide a link to the Creative Commons licence, and indicate if changes were made. The images or other third party material in this article are included in the article's Creative Commons licence, unless indicated otherwise in a credit line to the material. If material is not included in the article's Creative Commons licence and your intended use is not permitted by statutory regulation or exceeds the permitted use, you will need to obtain permission directly from the copyright holder. To view a copy of this licence, visit <http://creativecommons.org/licenses/by/4.0/>.

## References

1. Minniti S, Haque N, Nguyen P, Pemen G (2018) Local markets for flexibility trading: key stages. *Energies* 11(11):1–21
2. Colak I, Sagiroglu S, Fulli G, Yesilbudak M, Covrig CF (2016) A survey on the critical issues in smart grid technologies. *Renew Sustain Energy Rev* 54:396–405
3. Antoniadou-plytaria KE, Kouveliotis-lysiakatos IN, Member S, Georgilakis PS, Member S, Hatziaegyriou ND (2017) Distributed and decentralized voltage control of smart distribution networks: models, methods, and future research. *IEEE Trans Smart Grid* 8(6):2999–3008
4. Shareef H, Islam M, Mohamed A (2016) A review of the stage-of-the-art charging technologies, placement methodologies,

- and impacts of electric vehicles. *Renew Sustain Energy Rev* 64:403–420
5. Morstyn T, Hredzak B, Agelidis VG (2018) Control strategies for microgrids with distributed energy storage systems: an overview. *IEEE Trans Smart Grid* 9(4):3652–3666
  6. Liu J, Xiao Y, Member S, Li S, Liang W, Chen CLP (2012) Cyber security and privacy issues in smart grids. *IEEE Commun Surv Tutor* 14(4):981–997
  7. Andishgar MH, Gholipour E, Allah Hooshmand R (2017) An overview of control approaches of inverter-based microgrids in islanding mode of operation. *Renew Sustain Energy Rev* 80:1043–1060
  8. Nosratabadi SM, Hooshmand RA, Gholipour E (2017) A comprehensive review on microgrid and virtual power plant concepts employed for distributed energy resources scheduling in power systems. *Renew Sustain Energy Rev* 67:341–363
  9. Bayindir R, Hossain E, Kabalci E, Perez R (2014) A comprehensive study on microgrid technology. *Int J Renew Energy Res* 4(4):1094–1107
  10. Rocabert J, Luna A, Blaabjerg F, Paper I (2012) Control of power converters in AC microgrids. *IEEE Trans Power Electron* 27(11):4734–4749
  11. Llaría A, Curea O, Jiménez J, Camblong H (2011) Survey on microgrids: unplanned islanding and related inverter control techniques. *Renew Energy* 36(8):2052–2061
  12. Huang W, Lu M, Zhang L (2011) Survey on microgrid control strategies. *Energy Procedia* 12:206–212
  13. Wang Z, Guo Z (2017) Uncertain models of renewable energy sources. *J Eng* 2017(13):849–853
  14. Martín-Martínez F, Sánchez-Miralles A, Rivier M (2016) A literature review of microgrids: a functional layer based classification. *Renew Sustain Energy Rev* 62:1133–1153
  15. Haque MM, Wolfs P (2016) A review of high PV penetrations in LV distribution networks: Present status, impacts and mitigation measures. *Renew Sustain Energy Rev* 62:1195–1208
  16. The Union of the Electricity Industry (Eurelectric) (2013) Active distribution system management a key tool for the smooth integration. Euroelectric Pap., no
  17. Chen BM, Poor HV (2020) High-frequency power electronics at the grid edge: a bottom-up approach toward the smart grid. *IEEE Electr Mag* 8(3):6–17
  18. Karimi M, Mokhlis H, Naidu K, Uddin S, Bakar AHA (2016) Photovoltaic penetration issues and impacts in distribution network—a review. *Renew Sustain Energy Rev* 53:594–605
  19. Mai TT, Salazar M, Haque ANMM, Nguyen PH (2020) Stochastic modelling of the correlation between transformer loading and distributed energy resources in LV distribution networks. In: *CIREC 2020 Berlin workshop*, pp 1–5
  20. Anastasiadis AG, Kondylis GP, Polyzakis A, Vokas G (2019) Effects of increased electric vehicles into a distribution network. *Energy Procedia* 157:586–593
  21. Yazdani M, Mehrizi-Sani A (2014) Distributed control techniques in microgrids. *IEEE Trans Smart Grid* 5(6):2901–2909
  22. Han H, Hou X, Yang J, Wu J, Su M, Guerrero JM (2016) Review of power sharing control strategies for islanding operation of AC microgrids. *IEEE Trans Smart Grid* 7(1):200–215
  23. Shang L, Hu J, Yuan X, Chi Y (2017) Understanding inertial response of variable-speed wind turbines by defined internal potential vector. *Energies* 10(1):1–17
  24. Tamrakar U, Shrestha D, Maharjan M, Bhattarai B, Hansen T, Tonkoski R (2017) Virtual inertia: current trends and future directions. *Appl Sci* 7(7):654
  25. Shar S, Hu S (2015) Proposed future ancillary services in electric reliability council of Texas. In: *2015 IEEE Eindhoven PowerTech*
  26. Mai TT, Haque ANMM, Vo T, Nguyen PH, Pham MC (2018) Development of ICT infrastructure for physical LV microgrids. In: *Proceedings—2018 IEEE international conference on environment and electrical engineering and 2018 IEEE industrial and commercial power systems Europe, IEEEIC/I and CPS Europe 2018*
  27. Abbood HD, Benigni A (2018) Data-driven modeling of commercial photovoltaic microinverter. *Model Simul Eng* 2018:1–11
  28. Abdel-Rahim O, Funato H, Haruna J (2017) Grid-connected boost inverter for low-power PV applications with model predictive control. *J Eng* 2017(7):318–326
  29. Sintamarean NC, Blaabjerg F, Wang H, Yang Y (2014) Real field mission profile oriented design of a SiC-based PV-inverter application. *IEEE Trans Ind Appl* 50(6):4082–4089
  30. Halu A, Scala A, Khiyami A, González MC (2016) Data-driven modeling of solar-powered urban microgrids. *Sci Adv* 2(1):e1500700
  31. Relan R, Firouz Y, Timmermans JM, Schoukens J (2017) Data-driven nonlinear identification of Li-ion battery based on a frequency domain nonparametric analysis. *IEEE Trans Control Syst Technol* 25(5):1825–1832
  32. Wang Y, Zhang C, Chen Z (2017) On-line battery state-of-charge estimation based on an integrated estimator. *Appl Energy* 185:2026–2032
  33. Cagnano A, De Tuglie E (2018) Time domain identification of a simplified model of So–Nick BESS: a methodology validated with field experiments. *Electr Power Syst Res* 165:229–237
  34. Cagnano A, De Tuglie E (2018) On-line identification of simplified dynamic models: Simulations and experimental tests on the Capstone C30 microturbine. *Electr Power Syst Res* 157:145–156
  35. Blaifi S, Moulahoum S, Colak I, Merrouche W (2016) An enhanced dynamic model of battery using genetic algorithm suitable for photovoltaic applications. *Appl Energy* 169:888–898
  36. Windahl J, Runvik H, Velut S (2019) Platform for microgrid design and operation. In: *13th International modelica conference, Regensburg, Germany, vol 157*, pp 405–412
  37. Abrishambaf O, Faria P, Gomes L, Vale Z, Corchado JM (2017) Implementation of a real-time microgrid simulation platform based on centralized and distributed management. *Energies* 10(6):806
  38. Ahmadi-Ahangar R, Rosin A, Niaki AN, Palu I, Korötko T (2019) A review on real-time simulation and analysis methods of microgrids. *Int Trans Electr Energy Syst* 29(11):1–16
  39. Cagnano A, De Tuglie E, Mancarella P (2020) Microgrids: Overview and guidelines for practical implementations and operation. *Appl. Energy* 258:114039
  40. Hossain E, Kabalsi E, Bayindir R, Perez R (2014) Microgrid testbeds around the world: state of art. *Energy Convers Manag* 86:132–153
  41. Ustun TS, Ozansoy C, Zayegh A (2011) Recent developments in microgrids and example cases around the world—a review. *Renew Sustain Energy Rev* 15(8):4030–4041
  42. Bracco S, Delfino F, Pampararo F, Robba M, Rossi M (2013) The University of Genoa smart polygeneration microgrid test-bed facility: the overall system, the technologies and the research challenges. *Renew Sustain Energy Rev* 18:442–459
  43. De Souza Ribeiro LA, Saavedra OR, De Lima SL, De Matos JG (2011) Isolated micro-grids with renewable hybrid generation: the case of Lençóis island. *IEEE Trans Sustain Energy* 2(1):1–11
  44. Palma-Behnke R, Ortiz D, Reyes L, Jiménez-Estévez G, Garrido N (2011) A social SCADA approach for a renewable based microgrid—the Huatacondo project. In: *IEEE power energy society general meeting*
  45. Vergara PP, Mai TT, Burstein A, Nguyen PH (2019) Feasibility and performance assessment of commercial PV inverters



- operating with droop control for providing voltage support services. In: Proceedings of 2019 IEEE PES innovative smart grid technologies Europe ISGT-Europe 2019, pp 2–6
46. Lasseter RH et al (2011) CERTS microgrid laboratory test bed. *IEEE Trans Power Deliv* 26(1):325–332
  47. Cagnano A, De Tuglie E, Cicognani L (2017) Prince—electrical energy systems lab: a pilot project for smart microgrids. *Electr Power Syst Res* 148:10–17
  48. Minniti S, Haque ANMM, Paterakis NG, Nguyen PH (2019) A hybrid robust-stochastic approach for the day-ahead scheduling of an EV aggregator. In: IEEE PES powertech 2019 Milano, pp 1–6
  49. Steurer M, Bogdan F, Ren W, Sloderbeck M, Woodruff S (2007) Controller and power hardware-in-loop methods for accelerating renewable energy integration. In: 2007 IEEE power engineering society general meeting, PES, pp 5–8
  50. Ren W, Steurer M, Baldwin TL (2008) Improve the stability and the accuracy of power hardware-in-the-loop simulation by selecting appropriate interface algorithms. *IEEE Trans Ind Appl* 44(4):1286–1294
  51. Lauss GF, Faruque MO, Schoder K, Dufour C, Viehweider A, Langston J (2016) Characteristics and design of power hardware-in-the-loop simulations for electrical power systems. *IEEE Trans Ind Electron* 63(1):406–417
  52. Benigni A, Strasser T, De Carne G, Liserre M, Cupelli M, Monti A (2020) Real-time simulation-based testing of modern energy systems a review and discussion. In: IEEE industrial electronics magazine, pp 28–39
  53. Huerta F, Gruber JK, Prodanovic M, Matatagui P (2016) Power-hardware-in-the-loop-test beds evaluation tools for grid integration of distributed energy resources. In: IEEE industry applications magazine, IEEE
  54. Langston J et al (2012) Power hardware-in-the-loop testing of a 500 kW photovoltaic array inverter. In: IECON proceedings (industrial electronics conference), pp 4797–4802
  55. De Carne G, Buticchi G, Liserre M (2018) Current-type Power Hardware in the Loop (PHIL) evaluation for smart transformer application. In: Proceedings—2018 IEEE international conference on industrial electronics for sustainable energy systems, IESES 2018, vol 2018-Janua, pp 529–533
  56. Maniatopoulos M, Lagos D, Kotsampopoulos P, Hatzargyriou N (2017) Combined control and power hardware in-the-loop simulation for testing smart grid control algorithms. *IET Gener Transm Distrib* 11(12):3009–3018
  57. Bruske S, De Carne G, Buticchi G, Liserre M, Zhang H (2020) Extended operation range of photovoltaic inverters by current waveform shaping. *IEEE Trans Power Electron* 8993(c):1–15
  58. Karrari S, Baghaee HR, De Carne G (2020) Adaptive inertia emulation control for high-speed flywheel energy storage systems. In: IET generation, transmission & distribution
  59. Steurer M, Edrington CS, Sloderbeck M, Ren W, Langston J (2010) A megawatt-scale power hardware-in-the-loop simulation setup for motor drives. *IEEE Trans Ind Electron* 57(4):1254–1260
  60. Langston J et al (2019) Power hardware-in-the-loop simulation testing of a 200 MJ battery-based energy magazine for ship-board applications. In: 2019 IEEE electric ship technologies symposium, ESTS 2019, no. Pms 320, pp 39–44
  61. De Carne G, Buticchi G, Liserre M, Vournas C (2018) Real-time primary frequency regulation using load power control by smart transformers. *IEEE Trans Smart Grid* 10(5):5630–5639
  62. Mai TT, Haque ANMM, Nguyen PH (2019) Consensus-based distributed control for overvoltage mitigation in LV microgrids. In: IEEE PES Powertech 2019 Milano
  63. Rojas A, Rousan T (2017) Microgrid control strategy: derived from stakeholder requirements analysis. *IEEE Power Energy Mag* 15(4):72–79
  64. Molzahn DK et al (2017) A survey of distributed optimization and control algorithms for electric power systems. *IEEE Trans Smart Grid* 8(6):2941–2962
  65. Dimeas A, Tsikalakis A, Kariniotakis G, Korres G (2014) Microgrid control issues. In: Microgrids architectures and control, p 315
  66. Olivares DE et al (2014) Trends in microgrid control. *IEEE Trans Smart Grid* 5(4):1905–1919
  67. Karagiannopoulos S, Aristidou P, Hug G (2019) Data-driven local control design for active distribution grids using off-line optimal power flow and machine learning techniques. *IEEE Trans Smart Grid* 10(6):6461–6471
  68. Guerrero JM, Chandorkar M, Lee T, Loh PC (2013) Advanced control architectures for intelligent microgrids; part I: decentralized and hierarchical control. *Ind Electron IEEE Trans* 60(4):1254–1262
  69. Palizban O, Kauhaniemi K, Guerrero JM (2014) Microgrids in active network management—part I: hierarchical control, energy storage, virtual power plants, and market participation. *Renew Sustain Energy Rev* 36:428–439
  70. Meng L, Sanseverino ER, Luna A, Dragicevic T, Vasquez JC, Guerrero JM (2016) Microgrid supervisory controllers and energy management systems: a literature review. *Renew Sustain Energy Rev* 60:1263–1273
  71. Anand S, Fernandes BG, Guerrero JM (2013) Distributed control to ensure proportional load sharing and improve voltage regulation in low-voltage DC microgrids. *IEEE Trans Power Electron* 28(4):1900–1913
  72. M. Shahidehpour, Z. Li, S. Bahramirad, Z. Li, and W. Tian, “Networked Microgrids: Exploring the Possibilities of the IIT-Bronzeville Grid,” *IEEE Power and Energy Magazine*, vol. 15, no. 4, pp. 63–71, Jul-2017.
  73. Guerrero JM, Vasquez JC, Matas J, De Vicuña LG, Castilla M (2011) Hierarchical control of droop-controlled AC and DC microgrids—a general approach toward standardization. *IEEE Trans Ind Electron* 58(1):158–172
  74. Ortiz L, Gonz JW, Gutierrez LB, Llanes-santiago O (2020) A review on control and fault-tolerant control systems of AC/DC microgrids. *Heliyon* 6(8):e04799
  75. Basir Khan MR, Jidin R, Pasupuleti J (2016) Multi-agent based distributed control architecture for microgrid energy management and optimization. *Energy Convers Manag* 112:288–307
  76. Dou CX, Wang WQ, Hao DW, Bin Li X (2015) MAS-based solution to energy management strategy of distributed generation system. *Int J Electr Power Energy Syst* 69:354–366
  77. Minchala-Avila LI, Garza-Castañón LE, Vargas-Martínez A, Zhang Y (2015) A review of optimal control techniques applied to the energy management and control of microgrids. *Procedia Comput Sci* 52(1):780–787
  78. Etemadi AH, Davison EJ, Iravani R (2012) A decentralized robust control strategy for multi-DER microgrids part I: fundamental concepts. *IEEE Trans Power Deliv* 27(4):1843–1853
  79. Olivier F, Aristidou P, Ernst D, Van Cutsem T (2016) Active management of low-voltage networks for mitigating overvoltages due to photovoltaic units. *IEEE Trans Smart Grid* 7(2):926–936
  80. Zeraati M, Golshan MEH, Guerrero JM (2017) A consensus-based cooperative control of PEV battery and PV active power curtailment for voltage regulation in distribution networks. *IEEE Trans Smart Grid* 3053(1):1–11
  81. Haque ANMM, Nguyen PH, Vo TH, Bliet FW (2017) Agent-based unified approach for thermal and voltage constraint management in LV distribution network. *Electr Power Syst Res* 143:462–473

82. Morshed MJ, Fekih A (2016) A fault-tolerant control paradigm for microgrid-connected wind energy systems. *IEEE Syst J* 12:360–372
83. Chen X, Du Y, Wen H (2017) Forecasting based power ramp-rate control For PV systems without energy storage. In: 2017 IEEE 3rd international future energy electronics conference and ECCE Asia (IFEEC 2017—ECCE Asia), pp 733–738
84. Lei M et al (2018) An MPC-based ESS control method for PV power smoothing applications. *IEEE Trans Power Electron* 33(3):2136–2144
85. Degner T, Soultanis N, Engler A, de Muro AG (2013) Intelligent local controllers. In: *Microgrids: architectures and control*, pp 81–116
86. Kim J, Guerrero JM, Rodriguez P, Teodorescu R, Nam K (2011) Mode adaptive droop control with virtual output impedances for an inverter-based flexible AC microgrid. *IEEE Trans Power Electron* 26(3):689–701
87. Yang Y, Kim KA, Ballbjerg F, Sangwongwanich A (2019) Flexible active power control of PV systems. In: *Advances in grid-connected photovoltaic power conversion systems*, pp 153–185
88. Liu X, Member S, Aichhorn A, Member S, Liu L, Member S (2012) Coordinated control of distributed energy storage system with tap changer transformers for voltage rise mitigation under high photovoltaic penetration. *IEEE Trans Smart Grid* 3(2):897–906
89. Alam MJE, Muttaqi KM, Sutanto D (2013) Mitigation of rooftop solar PV impacts and evening peak support by managing available capacity of distributed energy storage systems. *IEEE Trans Power Syst* 28(4):3874–3884
90. Alam MJE, Muttaqi KM, Sutanto D (2012) Distributed energy storage for mitigation of voltage-rise impact caused by Rooftop Solar PV. In: 2012 IEEE PES general meeting, US, pp 881–886
91. Wang Y et al (2016) Coordinated control of distributed energy-storage systems for voltage regulation in distribution networks. *IEEE Trans Power Deliv* 31(3):1132–1141
92. Marra F, Yang G, Træholt C, Østergaard J, Member S, Larsen E (2014) A decentralized storage strategy for residential feeders with photovoltaics. *IEEE Trans Smart Grid* 5(2):974–981
93. Kabir MN, Mishra Y, Ledwich G, Dong ZY, Wong KP (2014) Coordinated control of grid-connected photovoltaic reactive power and battery energy storage systems to improve the voltage profile of a residential distribution feeder. *IEEE Trans Ind Informatics* 10(2):967–977
94. Chamana M, Chowdhury BH, Jahanbakhsh F (2018) Distributed control of voltage regulating devices in the presence of high PV penetration to mitigate ramp-rate issues. *IEEE Trans Smart Grid* 9(2):1086–1095
95. Lam RK, Yeh H (2014) PV Ramp limiting controls with adaptive smoothing filter through a battery energy storage system, In: 2013 IEEE international conference on power electronics and drive systems (PEDS), Japan, pp 881–886
96. Mai TT, Haque ANMM, Vo T, Nguyen PH (2018) Coordinated active and reactive power control for overvoltage mitigation in physical LV microgrids. In 2018 International conference on renewable power generation, pp 1–6
97. Dallmer-zerbe K, Fischer D, Biener W, Wille-haussmann B, Wittwer C (2016) Droop controlled operation of heat pumps on clustered distribution grids with high PV penetration. In: 2016 IEEE international energy conference, pp 1–6
98. Kinjyo Y, Palmer MD (2013) Autonomous power system control by decentralized controllable loads. In: 2013 IEEE international conference on power electronics and drive systems (PEDS), Japan, pp 881–886
99. Salpakari J, Lund P (2016) Optimal and rule-based control strategies for energy flexibility in buildings with PV. *Appl Energy* 161:425–436
100. Ijaz U, Sartori I, Georges L, Novakovic V (2014) Advanced control of heat pumps for improved flexibility of Net-ZEB towards the grid. *Energy Build* 69:74–84
101. Samadi A, Shayesteh E, Eriksson R, Rawn B, Söder L (2014) Multi-objective coordinated droop-based voltage regulation in distribution grids with PV systems. *Renew Energy* 71(3):315–323
102. Li D, Zhao B, Zhang X, Zhang L (2017) An improved droop control strategy for low-voltage microgrids based on distributed secondary power optimization control. *Energies* 10:1347
103. Mansoor VMAM, Nguyen PH, Kling WL (2015) An integrated control for overvoltage mitigation in the distribution network. In: *IEEE PES innovative smart grid technologies Europe*, pp 1–6
104. Zhong QC (2013) Robust droop controller for accurate proportional load sharing among inverters operated in parallel. *IEEE Trans Ind Electron* 60(4):1281–1290
105. Ghosh S, Rahman S, Pipattanasomporn M (2017) Distribution voltage regulation through active power curtailment with PV inverters and solar generation forecasts. *IEEE Trans Sustain Energy* 8(1):13–22
106. Dall'Anese E, Dhople SV, Johnson BB, Giannakis GB (2014) Optimal dispatch of photovoltaic inverters in residential distribution systems. *IEEE Trans Sustain Energy* 5(2):487–497
107. Stetz T, Marten F, Braun M (2013) Improved low voltage grid-integration of photovoltaic systems in Germany. *IEEE Trans Sustain Energy* 4(2):534–542
108. Alam MJE, Muttaqi KM, Sutanto D (2015) A multi-mode control strategy for VAR support by solar PV inverters in distribution networks. *IEEE Trans Power Syst* 30(3):1316–1326
109. Marra F, Fawzy YT, Bülo T, Blažič B (2012) Energy storage options for voltage support in low-voltage grids with high penetration of photovoltaic, pp 1–7
110. Chaudhary P, Rizwan M (2018) Voltage regulation mitigation techniques in distribution system with high PV penetration: a review. *Renew Sustain Energy Rev* 82:3279–3287
111. Demirok E, González PC, Frederiksen KHB, Sera D, Rodriguez P, Teodorescu R (2011) Local reactive power control methods for overvoltage prevention of distributed solar inverters in low-voltage grids. *IEEE J Photovoltaics* 1(2):174–182
112. Von Appen J, Stetz T, Braun M, Schmiegel A (2014) Local voltage control strategies for PV storage systems in distribution grids. *IEEE Trans Smart Grid* 5(2):1002–1009
113. Turitsyn K, Šulc P, Backhaus S, Chertkov M (2011) Options for control of reactive power by distributed photovoltaic generators. *Proc IEEE* 99(6):1063–1073
114. Weckx S, Gonzalez C, Driesen J (2014) Combined central and local active and reactive power control of PV inverters. *IEEE Trans Sustain Energy* 5(3):776–784
115. Ghosh S, Rahman S, Pipattanasomporn M (2014) Local distribution voltage control by reactive power injection from PV inverters enhanced with active power curtailment. In: *IEEE power energy society general meeting*, vol 2014-October
116. Tran QT et al (2009) Local voltage control of PVs in distribution networks. In: 20th International conference and exhibition on electricity distribution (CIRED 2009), no. 0012, pp 8–11, 2009.
117. Garg A, Jalali M, Kekatos V, Tech V, Antonio S, Antonio S (2018) Kernel-based learning for smart inverter control. In: 2018 IEEE global conference on signal and information processing, pp 875–879
118. Dobbe R, Sondermeijer O, Fridovich-keil D, Arnold D, Callaway D, Tomlin C (2020) Toward distributed energy services: decentralizing optimal power flow with machine learning. *IEEE Trans Smart Grid* 11(2):1296–1306
119. Sondermeijer O, Dobbe R, Arnold D, Tomlin C, Regression-based inverter control for decentralized optimal power flow and

- voltage regulation. In: 2016 IEEE power & energy society general meeting, pp 1–5.
120. Li S, Member S, Sun Y, Member S, Ramezani M (2019) Artificial neural networks for volt/VAR control of DER inverters at the grid edge. *IEEE Trans Smart Grid* 10(5):5564–5573
  121. Zhang B, Lam AYS, Domínguez-garcía AD (2015) An optimal and distributed method for voltage regulation in power distribution systems. *IEEE Trans Power Syst* 30(4):1714–1726
  122. Alyami S, Wang Y, Wang C, Zhao J, Zhao B (2014) Adaptive real power capping method for fair overvoltage regulation of distribution networks with high penetration of PV systems. *IEEE Trans Smart Grid* 5(6):2729–2738
  123. Loia V, Member S, Vaccaro A, Member S, Vaisakh K (2013) A self-organizing architecture based on cooperative fuzzy agents for smart grid voltage control. *IEEE Trans Ind Inform* 9(3):1415–1422
  124. Nguyen TL, Wang Y, Tran QT, Caire R, Xu Y, Besanger Y (2019) Agent-based distributed event-triggered secondary control for energy storage system in islanded microgrids—cyber-physical validation. In: *Proceedings—2019 IEEE international conference on environment and electrical engineering 2019 IEEE industrial and commercial power systems Europe. IEEEIC/I CPS Europe 2019*, pp 0–5
  125. Wang Y, Nguyen T-L, Xu Y, Tran Q-T, Caire R (2020) Peer-to-peer control for networked microgrids: multi-layer and multi-agent architecture design. *IEEE Trans Smart Grid* 30(3):1–11
  126. Weckx S, D’Hulst R, Claessens B, Driesensam J (2014) Multi-agent charging of electric vehicles respecting distribution transformer loading and voltage limits. *IEEE Trans Smart Grid* 5(6):2857–2867
  127. Valverde G, Van Cutsem T (2013) Model predictive control of voltages in active distribution networks. *IEEE Trans Smart Grid* 4(4):2152–2161
  128. Reynders G, Nuytten T, Saelens D (2013) Potential of structural thermal mass for demand-side management in dwellings. *Build Environ* 64:187–199
  129. Yang Y, Kim KA, Blaabjerg F, Sangwongwanich A (2019) Power electronic technologies for PV systems. In: *Advances in grid-connected photovoltaic power conversion systems*, pp 15–43